

# TeeJet<sup>®</sup>

TECHNOLOGIES

## CATALOG 52-M







# SPRAYSELECT TIP SELECTION APP

## SPRAY SOLUTIONS AT A TOUCH OF A BUTTON

SpraySelect allows you to quickly and easily choose the proper tip for your application. Just enter spacing, speed, and your target rate, select your droplet size category, and a list of top recommendations is provided.

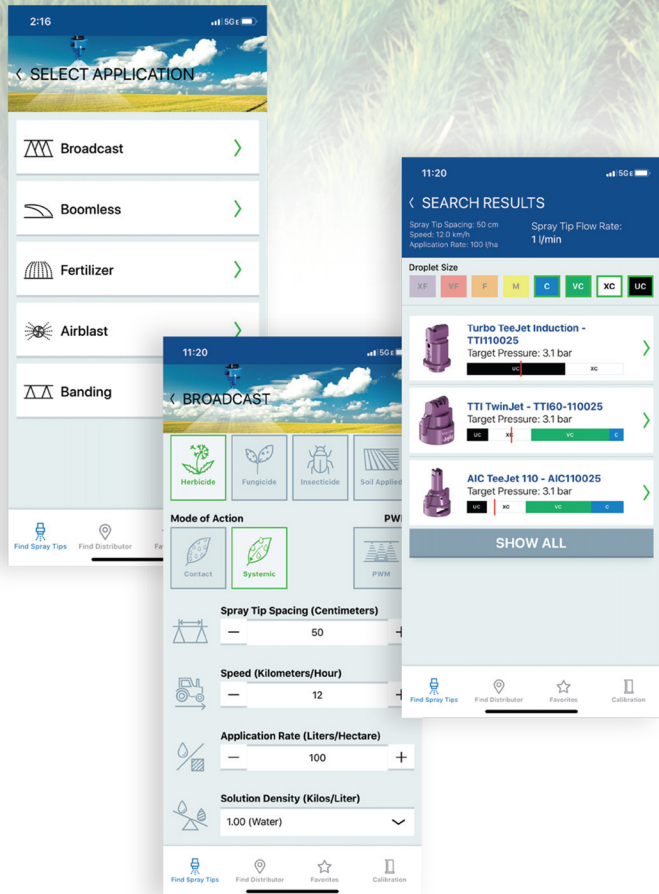
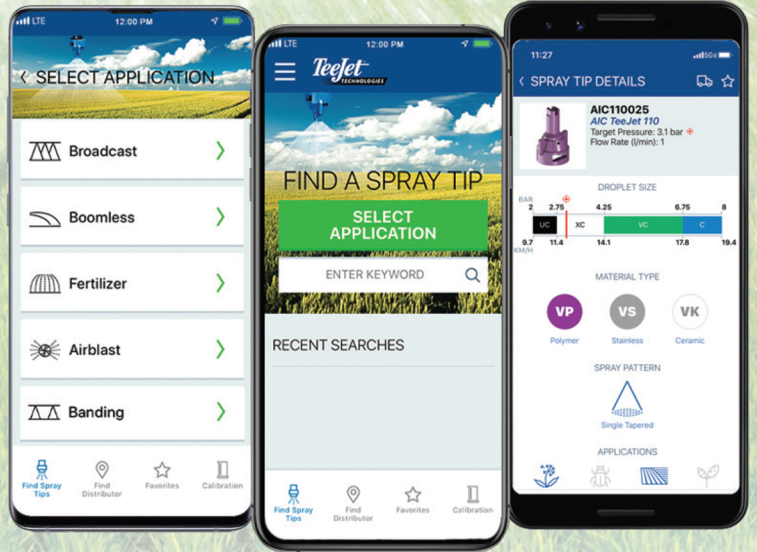

## APP FEATURES

- Find Spray Tips
  - Tip Spacing
  - Speed
  - Application Rate
  - Select Droplet Size
- Select Application
- Save Favorites
- Find Distributors Nearby
- Spray Tip Calibration

SCAN QR OR DOWNLOAD

Download on the **App Store**

ANDROID APP ON **Google play**





# TABLE OF CONTENTS

<b>CATALOG 52 NEW PRODUCTS</b>	4-5	<b>BOOM COMPONENTS</b>	118-143
<b>SELECTION GUIDE</b>	6-10	<b>VALVES &amp; MANIFOLDS</b>	144-165
<b>PWM SPRAY TIP SELECTION GUIDE</b>	11-13	<b>STRAINERS</b>	166-169
<b>BROADCAST NOZZLES</b>	14-57	<b>SPRAY GUNS</b>	170-178
<b>BOOMLESS NOZZLES</b>	58-63	<b>TECHNICAL INFORMATION</b>	179-202
<b>BANDING NOZZLES</b>	64-79		
<b>AIR BLAST NOZZLES</b>	80-91		
<b>FERTILIZER NOZZLES</b>	92-104		
<b>TANK RINSING NOZZLES</b>	105-106		
<b>ELECTRONICS</b>	107-117		

VISIT [TEEJET.COM](http://teejet.com)

COMPANY NEWS

TECHNICAL SUPPORT

PRODUCT  
INFORMATION

WHERE  
TO BUY

IMAGE LIBRARY





# KEY NEW PRODUCTS

## IN CATALOG 52

### 530A PLUNGER VALVES & MANIFOLDS PG 154-155

The compact 530A series of valves and manifolds provide a highly-configurable and versatile platform of products for sprayer operation. The 530A is available with manual or electric section control valves and is compatible with a wide range of existing and future accessory products. Manual and electric valves share a universal actuator attachment, allowing manual valves to be easily upgraded to electric operation. These plunger valves can be especially effective in applications using wettable powders or suspensions, where residues and buildup from inadequate flushing can be problematic.



### MATRIX® 908 PG 108-109

Matrix 908 is built for expandability, rugged performance, and easy operation in many agricultural and turf applications. The Matrix 908 offers a bright, clear display, intuitive menu structure and long-lasting construction.



### INDIVIDUAL SPRAY NOZZLE CONTROL VALVES PG 134

DynaJet®, DynaJet® HF, and EcoStop Valves are an essential part of a smart spraying system. TeeJet® solenoid valves are electronically controlled shutoffs that facilitate your precision spraying strategy more efficiently and sustainably, resulting in greater accuracy, increased yields, and less waste.



### VARIABLE RATE NOZZLES PG 94-95, 98-101

The new VR line of Variable Rate fertilizer StreamJet spray tips and metering bodies feature a flexible metering orifice that produces a much wider range of flow rates across standard operating pressures than can be achieved with fixed orifice nozzles. This allows for a wider range of ground speeds and/or application rates from a single orifice for improved productivity. They are also ideal for variable rate, prescription application. That flexible elastomer orifice provides consistent flow rate performance while utilizing a simple, reliable design with no springs or moving parts.



PG 94-95

PG 98-99

PG 100-101

PG 100-101

### CERAMIC TIPS PG 16-19

TeeJet now manufactures many popular TeeJet spray tip models with ceramic orifices in polypropylene tip bodies. These products provide outstanding resistance to wear and exceptional resistance to aggressive chemistries. Turbo TeeJet and AIXR TeeJet are the newest additions to the ceramic family.



PG 16-17

PG 18-19



## ACCUPULSE® TWINJET® TIPS PG 14-15

The AccuPulse (APTJ) uses a non-air induction design, to produce highly drift resistant XC and UC droplets with twin fan sprays for optimal performance in Pulse Width Modulation (PWM) control applications. The compact size and choice of numerous capacities will suit the needs of a wide range of application rates. APTJ tips are ideal for many uses in PWM controlled applications and are also suitable for use on conventional sprayers.



## QUICK TEEJET® CAPS PG 118-119

Quick TeeJet caps continue to offer fast, convenient installation or replacement of spray tips. Updated caps are now available in a variety of the most popular styles and colors, feature a cleaner design, and are constructed of acetal.



## QJ370 MULTIPLE NOZZLE BODY PG 124

The QJ370 multiple nozzle body features a compact design to fit onto a variety of sprayers and boom designs. QJ370 nozzle bodies are available for wet boom and dry boom installations. It has positive indexing that prevents accidental rotation. Optimized internal passages provide high flow rates for a wide range of ground speeds and application rates.



## QJS STACKABLE NOZZLE BODIES PG 120-123

The QJS multiple outlet, stackable nozzle body takes nozzle body versatility to a new level for both pull-type and self-propelled sprayers. The QJS is offered in three wet boom configurations, side or bottom inlet, with a choice of two, three, or four outlets. New options include integral flowmeter and high-strength stainless steel inlet tube. The QJS body can be equipped with any combination of TeeJet tip shutoffs including—pneumatic, electric, manual or spring-loaded check valve.



## XE BOOMLESS SPRAY TIP PG 62-63

The XE Extended Even Boomless Spray Tip is a wide, even spray pattern for fewer passes through the field and the ability to cover more area with each pass. They can be used in a variety of handheld or mechanized applications—such as fruits & vegetables, greenhouses, home gardens, urban pest control, sugar cane, and flowers.



## TTI TWINJET® TIPS PG 26-27

The TTI60 TwinJet air induction twin flat spray tip provides coarse to ultra coarse droplet size for maximum drift control along with the improved coverage of a twin spray. The single piece tip and cap design allows for fast, easy installation and, unlike some other twin sprays, has a very compact size. The TTI60 is ideal for the application of soil applied and systemic herbicides.





# TeeJet® SPRAY TIP SELECTION FOR CROPS

Crop protection product application in crops occurs at different growth stages. The right spray tip selection will result in maximum coverage and efficacy while reducing drift. TeeJet has several spray tips that provide the perfect balance of coverage and drift reduction. Check out some examples of TeeJet spray tips that most suit applications in corn, soybean, and wheat.

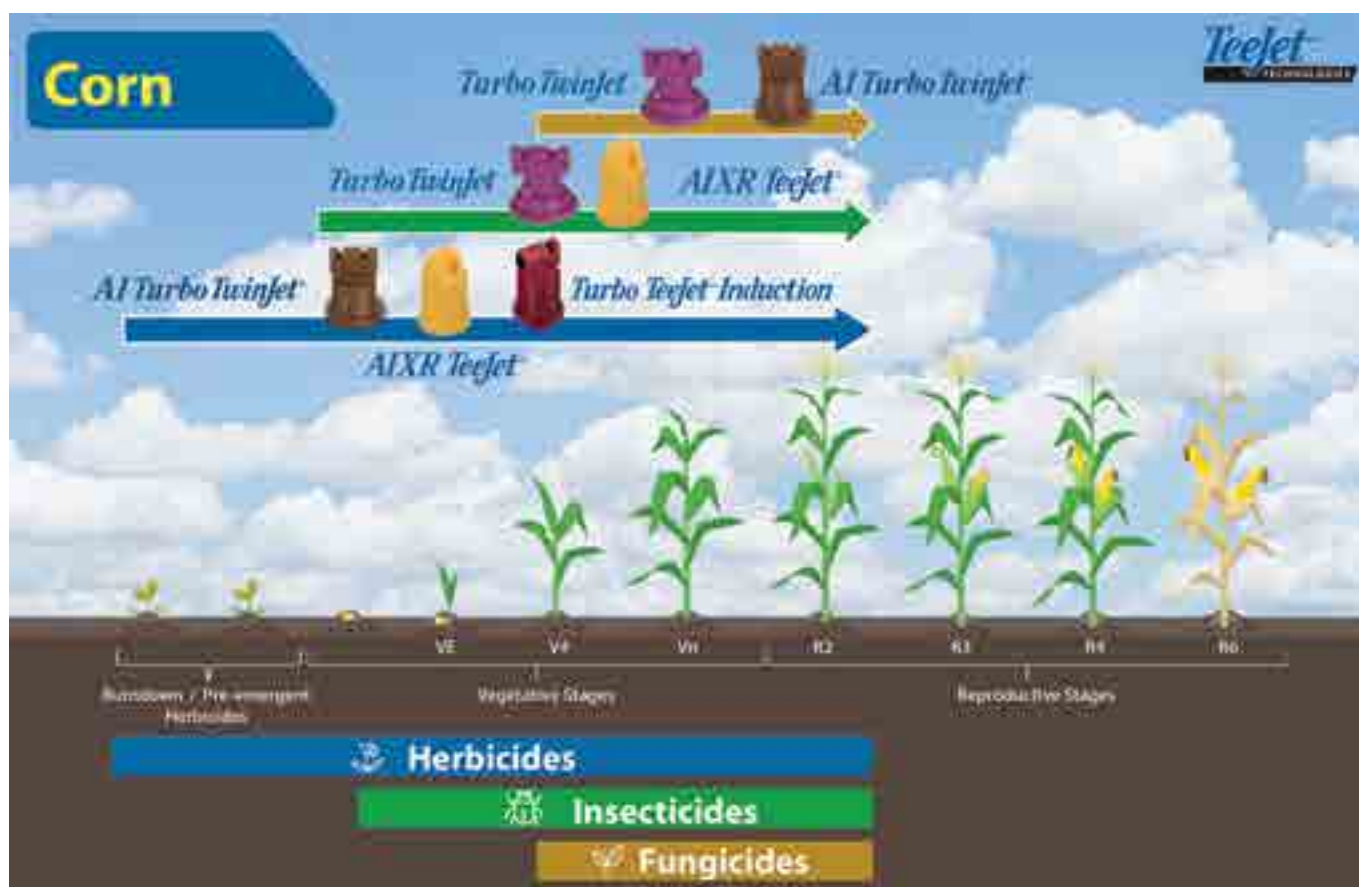



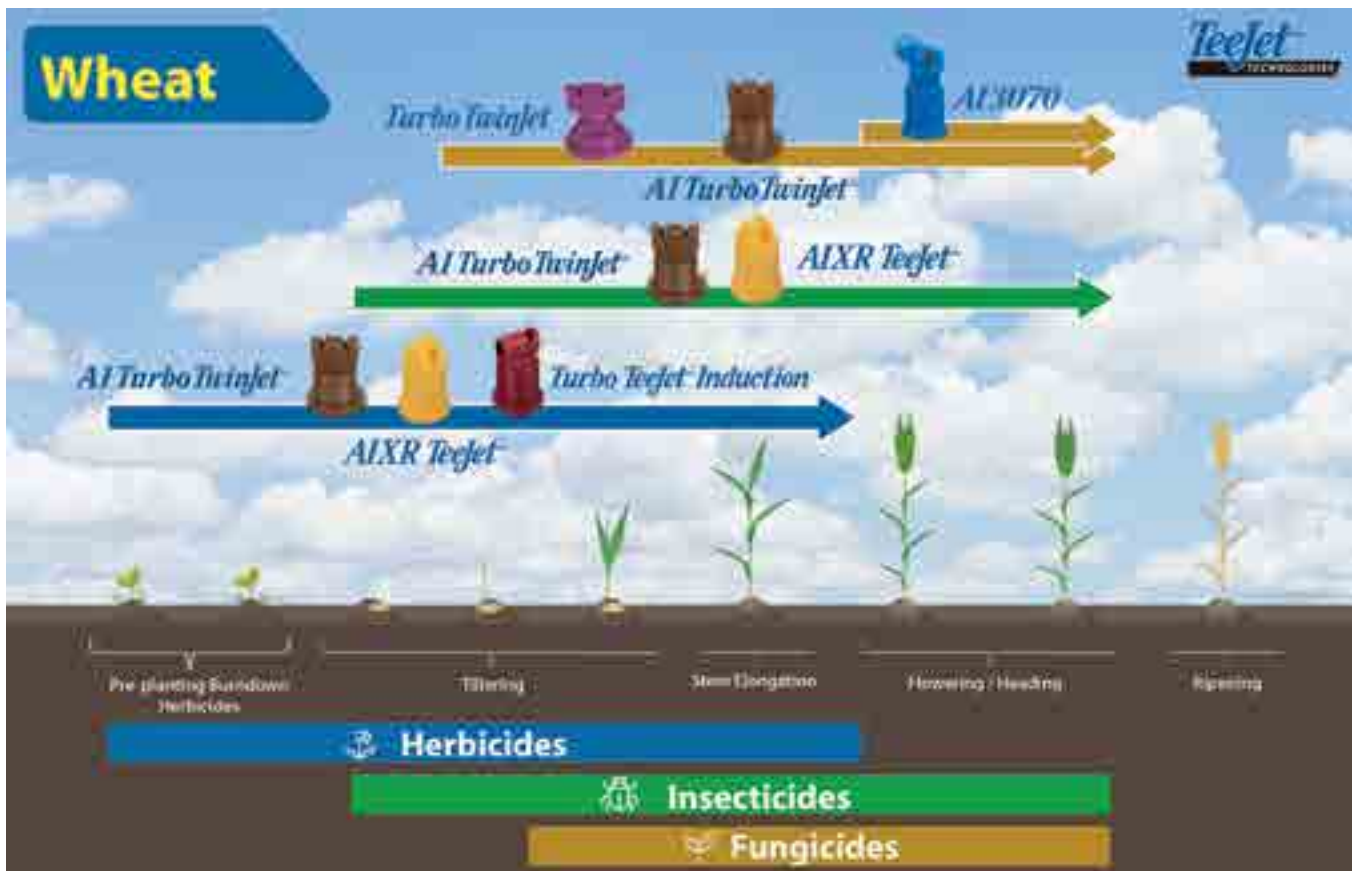
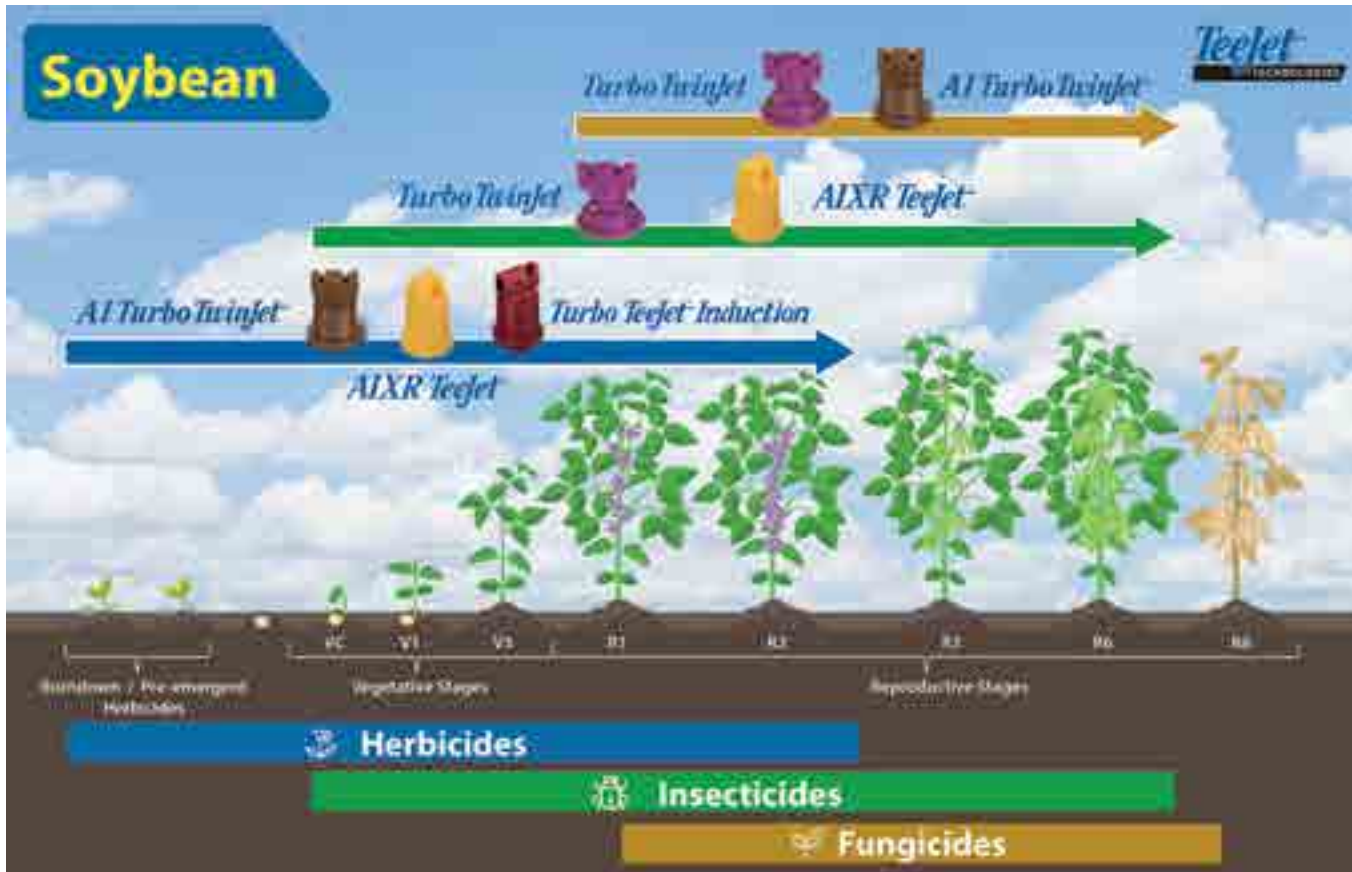



<b>SPRAY TIPS &amp; DROPLET SIZE*</b> 	<b>HERBICIDES</b>		<b>FUNGICIDES</b>		<b>INSECTICIDES</b>		
	<b>SOIL APPLIED</b>	<b>POST-EMERGENCE</b>		<b>CONTACT</b>	<b>SYSTEMIC</b>	<b>CONTACT</b>	<b>SYSTEMIC</b>
		<b>CONTACT</b>	<b>SYSTEMIC</b>				
<b>AccuPulse TwinJet<sup>+</sup></b> APTJ Pages 14–15	EXCELLENT		EXCELLENT				
<b>Turbo TeeJet<sup>+</sup></b> TT Pages 16–17		EXCELLENT	VERY GOOD	EXCELLENT	VERY GOOD	EXCELLENT	VERY GOOD
<b>AI XR TeeJet<sup>+</sup></b> AI XR Pages 18–19	VERY GOOD	EXCELLENT	VERY GOOD	GOOD	VERY GOOD	VERY GOOD	EXCELLENT
<b>Air Induction TeeJet<sup>+</sup></b> AI & AIC Pages 20–23	VERY GOOD		EXCELLENT		GOOD		VERY GOOD
<b>Turbo TeeJet Induction</b> TTI Pages 24–25	EXCELLENT		EXCELLENT				
<b>TTI TwinJet<sup>+</sup></b> TTI60 Pages 26–27	EXCELLENT		EXCELLENT				
<b>XR, XRC TeeJet<sup>+</sup></b> XR & XRC Pages 28–31		VERY GOOD	GOOD	EXCELLENT	GOOD	EXCELLENT	GOOD
<b>Turbo TwinJet<sup>+</sup></b> TTJ60 Pages 36–37	GOOD	EXCELLENT	VERY GOOD	EXCELLENT	VERY GOOD	EXCELLENT	VERY GOOD
<b>AI Turbo TwinJet<sup>+</sup></b> AITTJ60 Pages 38–39	VERY GOOD	VERY GOOD	EXCELLENT	GOOD	EXCELLENT	GOOD	EXCELLENT
<b>AI3070<sup>+</sup></b> AI3070 Pages 40–41				EXCELLENT	VERY GOOD		
<b>StreamJet</b> SJ3 & SJ3-VR Pages 92–95							
<b>StreamJet</b> SJ7A & SJ7A-VR Pages 96–99							
<b>StreamJet</b> PTC-VR & QJ-VR Pages 100–101							
<b>StreamJet</b> SOLID STREAM Pages 104							

**Note:** Consult the chemical manufacturer's product label for specific rate and application recommendations. Droplet size categories shown are based on ISO 25358.  
 \*(XF) Extremely Fine, (VF) Very Fine, (F) Fine, (M) Medium, (C) Coarse, (VC) Very Coarse, (XC) Extremely Coarse, (UC) Ultra Coarse



FERTILIZER		 DRIFT CONTROL	 PWM APPROVED
 BROADCAST	 DIRECTED		
EXCELLENT		EXCELLENT	✓
EXCELLENT		GOOD	✓
		VERY GOOD	
VERY GOOD		EXCELLENT	
EXCELLENT		EXCELLENT	✓
EXCELLENT		EXCELLENT	✓
		GOOD	✓
		VERY GOOD	✓
		EXCELLENT	✓
		VERY GOOD	
EXCELLENT		EXCELLENT	
EXCELLENT		EXCELLENT	
	EXCELLENT	EXCELLENT	
	EXCELLENT	EXCELLENT	

## LIQUID FERTILIZER APPLICATION

Just as in applying crop protection products, the proper application of liquid fertilizer is important. Delivering nutrients to the crop in a timely and effective manner while minimizing crop damage is essential. TeeJet Technologies offers an extensive selection of spray tips specifically designed to maximize the performance of your liquid fertilizer application.

Solid stream nozzles, offered in both single and multiple-stream versions, are designed to deliver fertilizer to the soil surface where it can be effectively utilized by the crop. By creating solid liquid streams, these tips greatly reduce foliar coverage in standing crop in order to minimize leaf burn. TeeJet Technologies StreamJet tips provide the ideal blend of compact, reliable design, ease of installation and affordable pricing.

In some cases, the use of a broadcast nozzle for fertilizer application may be desirable. This could include combined fertilizer/pesticide applications, foliar feeding or broadcast liquid fertilization of bare ground. For these applications TeeJet Technologies offers a wide variety of low drift, flat spray tips.

## LIQUID DENSITY CONVERSION

When selecting a specific capacity tip for liquid fertilizer application, always correct for liquid density. Application charts shown in this catalog are based on spraying water. Many fertilizer solutions are denser than water, which will affect the application rate. Please see page 185 for a list of density conversion factors.



### EXAMPLE

Desired application rate is 100 l/ha of 1.28 kg/l Nitrogen. Determine the correct nozzle size as follows:

$$l/ha \text{ (liquid other than water)} \times \text{Conversion Factor} = l/ha^*$$

$$100 \text{ l/ha (1.28 kg/l solution)} \times 1.13 = 113 \text{ l/ha (water)}$$

The applicator should choose a tip size that will supply 113 l/ha of water at the desired pressure.

\*From table in catalog.



		HERBICIDES			FUNGICIDES		INSECTICIDES	
		SOIL APPLIED	POST-EMERGENCE		CONTACT	SYSTEMIC	CONTACT	SYSTEMIC
			CONTACT	SYSTEMIC				
BANDING	<b>XE TeeJet</b> Pages 62–63	EXCELLENT		EXCELLENT		GOOD		GOOD
	<b>AI TeeJet</b> <small>EVEN</small> Pages 64–65	VERY GOOD		EXCELLENT		GOOD		VERY GOOD
	<b>TeeJet</b> <small>EVEN</small> Pages 68–69	EXCELLENT	VERY GOOD	GOOD	EXCELLENT	GOOD	EXCELLENT	GOOD
	<b>TwinJet</b> <small>EVEN</small> Pages 70–71		VERY GOOD		VERY GOOD		VERY GOOD	
DIRECTED SPRAYING	<b>AI TeeJet</b> <small>EVEN</small> Pages 64–65	VERY GOOD		EXCELLENT		EXCELLENT		EXCELLENT
	<b>TeeJet</b> <small>EVEN</small> Pages 68–69	EXCELLENT	VERY GOOD	GOOD	EXCELLENT	GOOD	EXCELLENT	GOOD
	<b>TwinJet</b> <small>EVEN</small> Pages 70–71		VERY GOOD		VERY GOOD		VERY GOOD	
	<b>AIUB TeeJet</b> Pages 72–73		GOOD	EXCELLENT				GOOD
	<b>ConeJet</b> Pages 78–79				EXCELLENT	VERY GOOD	EXCELLENT	VERY GOOD
AIR BLAST	<b>TXR ConeJet</b> Pages 84–85				EXCELLENT	GOOD	EXCELLENT	GOOD
	<b>AITX ConeJet</b> Pages 86–87		GOOD	EXCELLENT	VERY GOOD	EXCELLENT	VERY GOOD	EXCELLENT
	<b>Disc-Core</b> Pages 89–91				EXCELLENT	GOOD	EXCELLENT	GOOD

**Note:** Consult the chemical manufacturer's product label for specific rate and application recommendations.



# MAKE EVERY DROP COUNT WITH YOUR PWM CONTROL

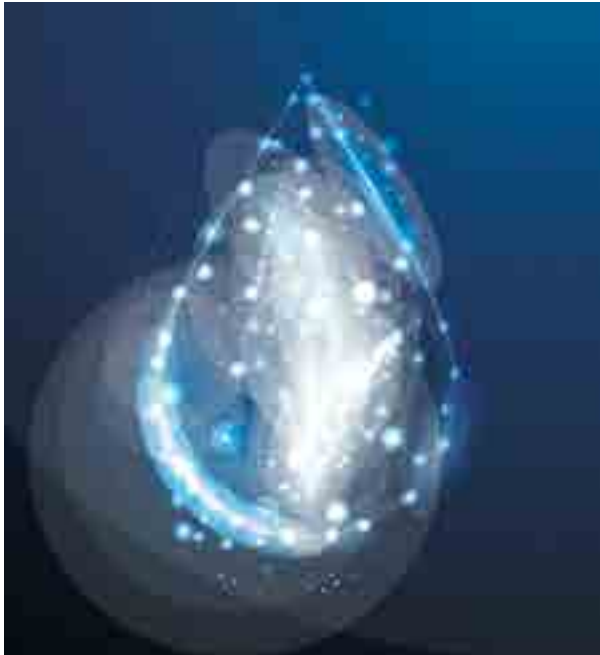

PWM spray tip control systems, like DynaJet®, use a PWM (Pulse Width Modulation) valve located at the nozzle body to adjust spray tip flow rate when changes in speed are detected. Spray tips that are paired with PWM controls are serving two main purposes—the formation of the spray pattern and droplet size. Target droplet size selection should be based on providing sufficient coverage for proper control while balancing out needs for drift management.

With air induction tips air is mixed with water through a venturi air aspirator that produces large air-filled droplets. When a PWM valve is used in conjunction with certain air induction tips, the mixing chamber and air inlet can fill with water as the PWM valve cycles. This can then result in water escaping out the air inlet holes, which can lead to poor distribution. New designs in air-induction tips however, have been proven to work well with PWM valves and nozzle control systems.

## WHAT MAKES A TEEJET SPRAY TIP “PWM APPROVED”?

Based on a combination of field and laboratory testing, PWM approved spray tips must meet the following criteria at a variety of duty-cycles:

- Excellent spray distribution in the direction of travel
- Rapid and complete spray pattern formation
- Excellent spray distribution across the boom
- Skip-free application
- Droplet size consistency





# DYNAJET® PWM APPLICATION RATE CHARTS FOR SYSTEMS EQUIPPED WITH 115880 DYNAJET VALVES

## 35 CM TIP SPACING

SELECTION GUIDE

TIP SIZE	GAUGE PRESSURE (bar)	30% MINIMUM DUTY CYCLE								SPEED RANGE (km/h)																		
		TJ60		TT	TTJ60	AITTJ60	AI/AIC	TTI60	TTI	APTJ*	50 l/ha		75 l/ha		100 l/ha		125 l/ha		150 l/ha		175 l/ha		200 l/ha		250 l/ha		300 l/ha	
		XR/XRC	VC								MIN	MAX	MIN	MAX	MIN	MAX	MIN	MAX	MIN	MAX	MIN	MAX	MIN	MAX	MIN	MAX	MIN	MAX
11001	1		F	VC							2	8	1.6	5	1.2	4	0.9	3	0.8	3	0.7	2	0.6	2	0.5	1.6	0.4	1.3
	1.5		F	VC							3	10	2	6	1.4	5	1.2	4	1.0	3	0.8	3	0.7	2	0.6	2	0.5	1.6
	2		F	VC							3	11	2	7	1.6	5	1.3	4	1.1	4	0.9	3	0.8	3	0.7	2	0.5	1.8
	3		F	M							4	13	3	9	2	7	1.6	5	1.3	4	1.1	4	1.0	3	0.8	3	0.7	2
	4		VF	M							5	15	3	10	2	8	1.9	6	1.5	5	1.3	4	1.2	4	0.9	3	0.8	3
	5			F							5	17	3	12	3	9	2	7	1.7	6	1.5	5	1.3	4	1.0	3	0.9	3
6			F							6	19	4	13	3	9	2	8	1.9	6	1.6	5	1.4	5	1.1	4	0.9	3	
110015	1		M	VC						UC	3	12	2	8	1.7	6	1.4	5	1.2	4	1.0	3	0.9	3	0.7	2	0.6	2
	1.5		F	VC						UC	4	14	3	10	2	7	1.7	6	1.4	5	1.2	4	1.1	4	0.9	3	0.7	2
	2		F	C						XC	5	16	3	11	2	8	2	7	1.6	5	1.4	5	1.2	4	1.0	3	0.8	3
	3		F	M						XC	6	20	4	13	3	10	2	8	2	7	1.7	6	1.5	5	1.2	4	1.0	3
	4		F	M						VC	7	23	5	16	3	12	3	9	2	8	2	7	1.7	6	1.4	5	1.2	4
	5			M						VC	8	26	5	17	4	13	3	10	3	9	2	7	2	7	1.6	5	1.3	4
	6			F						VC	9	28	6	19	4	14	3	11	3	9	2	8	2	7	1.7	6	1.4	5
7									C	9	31	6	21	5	15	4	12	3	10	3	9	2	8	1.9	6	1.5	5	
11002	1		M	VC						UC	5	15	3	10	2	8	1.9	6	1.5	5	1.3	4	1.2	4	0.9	3	0.8	3
	1.5		M	VC						UC	6	19	4	13	3	9	2	8	1.9	6	1.6	5	1.4	5	1.1	4	0.9	3
	2		F	C						XC	7	22	4	15	3	11	3	9	2	7	1.9	6	1.6	5	1.3	4	1.1	4
	3		F	F						XC	8	27	5	18	4	14	3	11	3	9	2	8	2	7	1.6	5	1.4	5
	4		F	F						VC	9	31	6	21	5	16	4	12	3	10	3	9	2	8	1.9	6	1.6	5
	5			M						VC	10	35	7	23	5	17	4	14	3	12	3	10	3	9	2	7	1.7	6
	6			F						VC	12	38	8	26	6	19	5	15	4	13	3	11	3	10	2	8	2	6
7									C	12	41	8	28	6	21	5	17	4	14	4	12	3	10	2	8	2	7	
11025	1		M	VC						UC	6	19	4	13	3	10	2	8	2	6	1.6	5	1.4	5	1.2	4	1.0	3
	1.5		M	VC						UC	7	24	5	16	4	12	3	9	2	8	2	7	1.8	6	1.4	5	1.2	4
	2		M	C						XC	8	27	5	18	4	14	3	11	3	9	2	8	2	7	1.6	5	1.4	5
	3		F	M						VC	10	34	7	22	5	17	4	13	3	11	3	10	3	8	2	7	1.7	6
	4		F	M						VC	12	39	8	26	6	19	5	15	4	13	3	11	3	10	2	8	2	6
	5			M						VC	13	43	9	29	6	22	5	17	4	14	4	12	3	11	3	9	2	7
	6			F						C	14	47	9	32	7	24	6	19	5	16	4	14	4	12	3	9	2	8
7									C	15	51	10	34	8	26	6	21	5	17	4	15	4	13	3	10	3	9	
11003	1.5		M	VC						UC	8	28	6	19	4	14	3	11	3	9	2	8	2	7	1.7	6	1.4	5
	2		M	C						UC	10	32	6	21	5	16	4	13	3	11	3	9	2	8	2	6	1.6	5
	3		F	F						XC	12	40	8	27	6	20	5	16	4	13	3	11	3	10	2	8	2	7
	4		F	F						VC	14	46	9	31	7	23	6	18	5	15	4	13	3	11	3	9	2	8
	5			M						VC	15	51	10	34	8	26	6	20	5	17	4	15	4	13	3	10	3	9
	6			F						C	17	56	11	37	8	28	7	22	6	19	5	16	4	14	3	11	3	9
	7									C	18	61	12	40	9	30	7	24	6	20	5	17	5	15	4	12	3	10
11004	1.5		M	VC						UC	11	37	7	25	6	19	4	15	4	12	3	11	3	9	2	7	1.9	6
	2		M	C						UC	13	43	9	29	6	21	5	17	4	14	4	12	3	11	3	9	2	7
	3		F	M						XC	16	52	10	35	8	26	6	21	5	17	4	15	4	13	3	10	3	9
	4		F	F						VC	18	61	12	40	9	30	7	24	6	20	5	17	5	15	4	12	3	10
	5			M						VC	20	68	14	45	10	34	8	27	7	23	6	19	5	17	4	14	3	11
	6			F						C	22	74	15	50	11	37	9	30	7	25	6	21	6	19	4	15	4	12
	7									C	24	80	16	53	12	40	10	32	8	27	7	23	6	20	5	16	4	13
11005	1.5		M	VC						UC	14	45	9	30	7	23	5	18	5	15	4	13	3	11	3	9	2	8
	2		M	M						UC	16	52	10	35	8	26	6	21	5	17	4	15	4	13	3	10	3	9
	3		M	M						XC	19	64	13	43	10	32	8	26	6	21	6	18	5	16	4	13	3	11
	4		M	F						VC	22	75	15	50	11	37	9	30	7	25	6	21	6	19	4	15	4	12
	5			M						VC	25	84	17	56	13	42	10	33	8	28	7	24	6	21	5	17	4	14
	6			F						C	27	92	18	61	14	46	11	37	9	31	8	26	7	23	5	18	5	15
	7									C	30	99	20	66	15	49	12	39	10	33	8	28	7	25	6	20	5	16
11006	1.5		M	VC						UC	16	53	11	36	8	27	6	21	5	18	5	15	4	13	3	11	3	9
	2		M	C						UC	19	62	12	41	9	31	7	25	6	21	5	18	5	16	4	12	3	10
	3		M	C						XC	23	76	15	51	11	38	9	31	8	25	7	22	6	19	5	15	4	13
	4		M	M						VC	26	88	18	59	13	44	11	35	9	29	8	25	7	22	5	18	4	15
	5			M						VC	30	99	20	66	15	49	12	39	10	33	8	28	7	25	6	20	5	16
	6			F						C	32	108	22	72	16	54	13	43	11	36	9	31	8	27	6	22	5	18
	7			F						C	35	117	23	78	18	58	14	47	12	39	10	33	9	29	7	23	6	19
11008	1.5		C	XC						UC	20	67	13	45	10	34	8	27	7	22	6	19	5	17	4	13	3	11
	2		M	VC						UC	23	78	16	52	12	39	9	31	8	26	7	22	6	20	5	16	4	13
	3		M	M						XC	29	96	19	64	14	48	12	39	10	32	8	28	7	24	6	19	5	16
	4		M	M						XC	33	111	22	74	17	56	13	45	11	37	10	32	8	28	7	22	6	19
	5		M	M						VC	37	125	25	83	19	62	15	50	12	42	11	36	9	31	7	25	6	21
	6			M						VC	41	137	27	91	21	68	16	55	14	46	12	39	10	34	8	27	7	23
	7			M						VC	44	148	30	99	22	74	18	59	15	49	13	42	11	37	9	30	7	25
11010	1.5		C	UC						UC	23	78	16	52	12	39	9	31	8	26	7	22	6	20	5	16	4	13
	2		C	XC																								





# DYNAJET® PWM APPLICATION RATE CHARTS FOR SYSTEMS EQUIPPED WITH 115880 DYNAJET VALVES



50 CM TIP SPACING

SELECTION GUIDE

TIP SIZE	GAUGE PRESSURE (bar)	30% MINIMUM DUTY CYCLE								SPEED RANGE (km/h)																		
		T160	XR/XRC	TT	TT160	A1TT160	AI/AIC	TT160	TT1	APTJ*	50 l/ha		75 l/ha		100 l/ha		125 l/ha		150 l/ha		175 l/ha		200 l/ha		250 l/ha		300 l/ha	
											MIN	MAX	MIN	MAX	MIN	MAX	MIN	MAX	MIN	MAX	MIN	MAX	MIN	MAX	MIN	MAX	MIN	MAX
11001	1		F	VC							1.7	6	1.1	4	0.8	3	0.7	2	0.6	1.8	0.5	1.6	0.4	1.4	0.3	1.1	0.3	0.9
	1.5		F	C							2	7	1.3	4	1.0	3	0.8	3	0.7	2	0.6	2	0.5	1.7	0.4	1.3	0.3	1.1
	2		F	C							2	8	1.5	5	1.2	4	0.9	3	0.8	3	0.7	2	0.6	2	0.5	1.5	0.4	1.3
	3		F	M							3	9	1.9	6	1.4	5	1.1	4	0.9	3	0.8	3	0.7	2	0.6	1.9	0.5	1.6
	4		VF	M							3	11	2	7	1.6	5	1.3	4	1.1	4	0.9	3	0.8	3	0.6	2	0.5	1.8
	5			F							4	12	2	8	1.8	6	1.5	5	1.2	4	1.0	3	0.9	3	0.7	2	0.6	2
110015	1		M	VC							2	8	1.6	5	1.2	4	1.0	3	0.8	3	0.7	2	0.6	2	0.5	1.6	0.4	1.4
	1.5		F	VC						UC	3	10	2	7	1.5	5	1.2	4	1.0	3	0.9	3	0.8	3	0.6	2	0.5	1.7
	2		F	C						UC	3	12	2	8	1.7	6	1.4	5	1.2	4	1.0	3	0.9	3	0.7	2	0.6	2
	3		F	M						XC	4	14	3	9	2	7	1.7	6	1.4	5	1.2	4	1.1	4	0.8	3	0.7	2
	4		F	M						XC	5	16	3	11	2	8	2	7	1.6	5	1.4	5	1.2	4	1.0	3	0.8	3
	5			M						VC	5	18	4	12	3	9	2	7	1.8	6	1.6	5	1.4	5	1.1	4	0.9	3
	6			F						VC	6	20	4	13	3	10	2	8	2	7	1.7	6	1.5	5	1.2	4	1.0	3
11002	1		M	VC							3	11	2	7	1.6	5	1.3	4	1.1	4	0.9	3	0.8	3	0.6	2	0.5	1.8
	1.5		M	VC						UC	4	13	3	9	2	7	1.6	5	1.3	4	1.1	4	1.0	3	0.8	3	0.7	2
	2		F	F	C					UC	5	15	3	10	2	8	1.8	6	1.5	5	1.3	4	1.2	4	0.9	3	0.8	3
	3		F	F	M					UC	6	19	4	13	3	9	2	8	1.9	6	1.6	5	1.4	5	1.1	4	0.9	3
	4		F	F	M					UC	7	22	4	15	3	11	3	9	2	7	1.9	6	1.6	5	1.3	4	1.1	4
	5			M						UC	7	24	5	16	4	12	3	10	2	8	2	7	1.8	6	1.5	5	1.2	4
	6			F	M					XC	8	27	5	18	4	13	3	11	3	9	2	8	2	7	1.6	5	1.3	4
110025	1		M	VC							4	13	3	9	2	7	1.6	5	1.3	4	1.2	4	1.0	3	0.8	3	0.7	2
	1.5		M	VC						UC	5	17	3	11	2	8	2	7	1.7	6	1.4	5	1.2	4	1.0	3	0.8	3
	2		M	C						UC	6	19	4	13	3	10	2	8	2	6	1.6	5	1.4	5	1.2	4	1.0	3
	3		F	M						UC	7	24	5	16	4	12	3	9	2	8	2	7	1.8	6	1.4	5	1.2	4
	4		F	M						UC	8	27	5	18	4	14	3	11	3	9	2	8	2	7	1.6	5	1.4	5
	5			M						UC	9	30	6	20	5	15	4	12	3	10	3	9	2	8	1.8	6	1.5	5
	6			F	M					XC	10	33	7	22	5	17	4	13	3	9	2	8	2	7	1.6	5	1.4	5
11003	1.5		M	VC							6	19	4	13	3	10	2	8	2	6	1.7	6	1.5	5	1.2	4	1.0	3
	2		F	F	C					UC	7	23	5	15	3	11	3	9	2	8	2	6	1.7	6	1.4	5	1.1	4
	3		F	F	M					UC	8	28	6	19	4	14	3	11	3	9	2	8	2	7	1.7	6	1.4	5
	4		F	F	M					UC	10	32	6	21	5	16	4	13	3	11	3	9	2	8	2	6	1.6	5
	5			M						UC	11	36	7	24	5	18	4	14	4	12	3	10	3	9	2	7	1.8	6
	6			F	M					XC	12	39	8	26	6	20	5	16	4	13	3	11	3	10	2	8	2	7
	7				M					XC	13	42	8	28	6	21	5	17	4	14	4	12	3	11	3	8	2	7
11004	1.5		M	VC							8	26	5	17	4	13	3	10	3	9	2	7	2	6	1.6	5	1.3	4
	2		M	C						UC	9	30	6	20	5	15	4	12	3	10	3	9	2	8	1.8	6	1.5	5
	3		F	M						UC	11	37	7	24	6	18	4	15	4	12	3	10	3	9	2	7	1.8	6
	4		F	M						UC	13	42	8	28	6	21	5	17	4	14	4	12	3	11	3	8	2	7
	5			M						UC	14	48	10	32	7	24	6	19	5	16	4	14	4	12	3	10	2	8
	6			F	M					XC	16	52	10	35	8	26	6	21	5	17	4	15	4	13	3	10	3	9
	7				M					XC	17	56	11	37	8	28	7	22	6	19	5	16	4	14	3	11	3	9
11005	1.5		M	VC							10	32	6	21	5	16	4	13	3	11	3	9	2	8	2	6	1.6	5
	2		M	M						UC	11	37	7	24	6	18	4	15	4	12	3	10	3	9	2	7	1.8	6
	3		M	M						UC	14	45	9	30	7	23	5	18	5	15	4	13	3	11	3	9	2	8
	4		M	F						UC	16	52	10	35	8	26	6	21	5	17	4	15	4	13	3	10	3	9
	5			M						UC	18	59	12	39	9	29	7	23	6	20	5	17	4	15	4	12	3	10
	6			F	M					XC	19	64	13	43	10	32	8	26	6	21	5	18	5	16	4	13	3	11
	7				M					XC	21	69	14	46	10	35	8	28	7	23	6	20	5	17	4	14	3	12
11006	1.5		M	VC							11	37	7	25	6	19	4	15	4	12	3	11	3	9	2	7	1.9	6
	2		M	C						UC	13	43	9	29	7	22	5	17	4	14	4	12	3	11	3	9	2	7
	3		M	M						UC	16	54	11	36	8	27	6	21	5	18	5	15	4	13	3	11	3	9
	4		M	M						UC	19	62	12	41	9	31	7	25	6	21	5	18	5	15	4	12	3	10
	5			M						UC	21	69	14	46	10	35	8	28	7	23	6	20	5	17	4	14	3	12
	6			F	M					XC	23	76	15	50	11	38	9	30	8	25	6	22	6	19	5	15	4	13
	7			F	M					XC	25	82	16	55	12	41	10	33	8	27	7	23	6	20	5	16	4	14
11008	1.5		C	XC							14	47	9	31	7	24	6	19	5	16	4	13	4	12	3	9	2	8
	2		M	C						UC	16	55	11	36	8	27	7	22	5	18	5	16	4	14	3	11	3	9
	3		M	C						UC	20	67	13	45	10	34	8	27	7	22	6	19	5	17	4	13	3	11
	4		M	M						UC	23	78	16	52	12	39	9	31	8	26	7	22	6	20	5	16	4	13
	5		M	M						UC	26	87	17	58	13	44	10	35	9	29	7	25	7	22	5	17	4	15
	6			M						XC	29	96	19	64	14	48	11	38	10	32	8	27	7	24	6	19	5	16
	7				M					XC	31	103	21	69	16	52	12	41	10	34	9	30	8	26	6	21	5	17
11010	1.5		C	XC							16	55	11	36	8	27	7	22	5	18	5	16	4	14	3	11	3	9
	2		C	VC						UC	19	63	13	42	10	32	8	25	6	21	5	18	5	16	4	13	3	11
	3		M	C						UC	23	78	16	52	12	39	9	31	8	26	7	22	6	20	5	16	4	13
	4		M	M						UC	27	90	18	60	14	45	11	36	9	30	8	26	7	23	5	18	5	15
	5		M	M						XC	30	101	20	67	15	51	12	40	10	34	9	29	8	25	6	20	5	17
	6			C	M					VC																		



## Typical Applications



**HERBICIDE**  
SOIL APPLIED  
**EXCELLENT**  
SYSTEMIC  
**EXCELLENT**



**FERTILIZER**  
BROADCAST  
**EXCELLENT**



**DRIFT CONTROL**  
**EXCELLENT**



**PWM APPROVED**



## FEATURES

- Specifically designed for use on sprayers equipped with Pulse Width Modulation (PWM) spray tip control.
- Can also be used for non-PWM applications, where maximum drift control is desired.
- Non-air induction Twin spray tip, that produces highly drift-resistant droplets (XC and UC).
- Patent-pending recirculating design and concave exit orifice geometry provide optimal spray performance.
- Twin spray pattern allows for improved coverage and canopy penetration.
- Compact design fits into tight boom spaces and is less likely to be damaged during field use.
- Available in ten VisiFlo® Polymer (VP) capacities.
- Optimal for burndown, pre-emerge, and post-emerge systemic applications.
- Automatic spray alignment with Quick TeeJet® cap and gasket 114441A-\*CELR (01 to 08) or 114502A-\*CELR (10 and 12). Reference page 118 for more information.

### SPRAY PATTERN



### DROPLET SIZE CLASSIFICATION

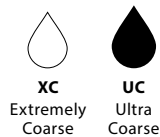

### OPTIMUM SPRAY HEIGHT

 <b>ANGLE</b>	<b>50 cm SPACING</b>  <b>HEIGHT</b>
110°	50 cm

### RECOMMENDED PRESSURE RANGE



### MATERIALS AVAILABLE



## HOW TO ORDER

Polymer with VisiFlo color-coding

**A P T J - 1 1 0 0 4 V P**

Tip Type    Spray Angle    Capacity Size    Material Code

Polymer with VisiFlo color-coding, includes Quick TeeJet® cap and gasket\*

**A P T J - 1 1 0 0 4 V P - C E**

Tip Type    Spray Angle    Capacity Size    Material Code    Cap and Gasket Included

\*Reference page 118 for more caps information.



# AccuPulse® TwinJet® TWIN FLAT SPRAY



BROADCAST NOZZLES

TIP PART NO. (STRAINER MESH SIZE)	bar	DROP SIZE	CAPACITY ONE NOZZLE IN l/min	APPLICATION RATE FOR 50 cm SPRAY TIP SPACING												
				l/ha												
				4 km/h	5 km/h	6 km/h	7 km/h	8 km/h	10 km/h	12 km/h	16 km/h	18 km/h	20 km/h	25 km/h	30 km/h	35 km/h
APTJ-110015VP (100)	1.5	UC	0.45	135	108	90.0	77.1	67.5	54.0	45.0	33.8	30.0	27.0	21.6	18.0	15.4
	2.0	UC	0.50	150	120	100	85.7	75.0	60.0	50.0	37.5	33.3	30.0	24.0	20.0	17.1
	3.0	UC	0.59	177	142	118	101	88.5	70.8	59.0	44.3	39.3	35.4	28.3	23.6	20.2
	4.0	UC	0.65	195	156	130	111	97.5	78.0	65.0	48.8	43.3	39.0	31.2	26.0	22.3
	5.0	XC	0.71	213	170	142	122	107	85.2	71.0	53.3	47.3	42.6	34.1	28.4	24.3
	6.0	XC	0.76	228	182	152	130	114	91.2	76.0	57.0	50.7	45.6	36.5	30.4	26.1
	7.0	XC	0.81	243	194	162	139	122	97.2	81.0	60.8	54.0	48.6	38.9	32.4	27.8
APTJ-110025VP (100)	1.5	UC	0.60	180	144	120	103	90.0	72.0	60.0	45.0	40.0	36.0	28.8	24.0	20.6
	2.0	UC	0.67	201	161	134	115	101	80.4	67.0	50.3	44.7	40.2	32.2	26.8	23.0
	3.0	UC	0.78	234	187	156	134	117	93.6	78.0	58.5	52.0	46.8	37.4	31.2	26.7
	4.0	UC	0.87	261	209	174	149	131	104	87.0	65.3	58.0	52.2	41.8	34.8	29.8
	5.0	XC	0.95	285	228	190	163	143	114	95.0	71.3	63.3	57.0	45.6	38.0	32.6
	6.0	XC	1.01	303	242	202	173	152	121	101	75.8	67.3	60.6	48.5	40.4	34.6
	7.0	XC	1.07	321	257	214	183	161	128	107	80.3	71.3	64.2	51.4	42.8	36.7
APTJ-110025VP (100)	1.5	UC	0.75	225	180	150	129	113	90.0	75.0	56.3	50.0	45.0	36.0	30.0	25.7
	2.0	UC	0.84	252	202	168	144	126	101	84.0	63.0	56.0	50.4	40.3	33.6	28.8
	3.0	UC	0.98	294	235	196	168	147	118	98.0	73.5	65.3	58.8	47.0	39.2	33.6
	4.0	UC	1.09	327	262	218	187	164	131	109	81.8	72.7	65.4	52.3	43.6	37.4
	5.0	XC	1.19	357	286	238	204	179	143	119	89.3	79.3	71.4	57.1	47.6	40.8
	6.0	XC	1.27	381	305	254	218	191	152	127	95.3	84.7	76.2	61.0	50.8	43.5
	7.0	XC	1.35	405	324	270	231	203	162	135	101	90.0	81.0	64.8	54.0	46.3
APTJ-11003VP (50)	1.5	UC	0.91	273	218	182	156	137	109	91.0	68.3	60.7	54.6	43.7	36.4	31.2
	2.0	UC	1.01	303	242	202	173	152	121	101	75.8	67.3	60.6	48.5	40.4	34.6
	3.0	UC	1.17	351	281	234	201	176	140	117	87.8	78.0	70.2	56.2	46.8	40.1
	4.0	UC	1.30	390	312	260	223	195	156	130	97.5	86.7	78.0	62.4	52.0	44.6
	5.0	XC	1.42	426	341	284	243	213	170	142	107	94.7	85.2	68.2	56.8	48.7
	6.0	XC	1.52	456	365	304	261	228	182	152	114	101	91.2	73.0	60.8	52.1
	7.0	XC	1.60	480	384	320	274	240	192	160	120	107	96.0	76.8	64.0	54.9
APTJ-11004VP (50)	1.5	UC	1.20	360	288	240	206	180	144	120	90.0	80.0	72.0	57.6	48.0	41.1
	2.0	UC	1.34	402	322	268	230	201	161	134	101	89.3	80.4	64.3	53.6	45.9
	3.0	UC	1.56	468	374	312	267	234	187	156	117	104	93.6	74.9	62.4	53.5
	4.0	UC	1.74	522	418	348	298	261	209	174	131	116	104	83.5	69.6	59.7
	5.0	XC	1.89	567	454	378	324	284	227	189	142	126	113	90.7	75.6	64.8
	6.0	XC	2.03	609	487	406	348	305	244	203	152	135	122	97.4	81.2	69.6
	7.0	XC	2.15	645	516	430	369	323	258	215	161	143	129	103	86.0	73.7
APTJ-11005VP (50)	1.5	UC	1.48	444	355	296	254	222	178	148	111	98.7	88.8	71.0	59.2	50.7
	2.0	UC	1.66	498	398	332	285	249	199	166	125	111	99.6	79.7	66.4	56.9
	3.0	UC	1.96	588	470	392	336	294	235	196	147	131	118	94.1	78.4	67.2
	4.0	UC	2.20	660	528	440	377	330	264	220	165	147	132	106	88.0	75.4
	5.0	XC	2.40	720	576	480	411	360	288	240	180	160	144	115	96.0	82.3
	6.0	XC	2.58	774	619	516	442	387	310	258	194	172	155	124	103	88.5
	7.0	XC	2.75	825	660	550	471	413	330	275	206	183	165	132	110	94.3
APTJ-11006VP (50)	1.5	UC	1.76	528	422	352	302	264	211	176	132	117	106	84.5	70.4	60.3
	2.0	UC	1.98	594	475	396	339	297	238	198	149	132	119	95.0	79.2	67.9
	3.0	UC	2.35	705	564	470	403	353	282	235	176	157	141	113	94.0	80.6
	4.0	UC	2.65	795	636	530	454	398	318	265	199	177	159	127	106	90.9
	5.0	XC	2.91	873	698	582	499	437	349	291	218	194	175	140	116	99.8
	6.0	XC	3.14	942	754	628	538	471	377	314	236	209	188	151	126	108
	7.0	XC	3.35	1005	804	670	574	503	402	335	251	223	201	161	134	115
APTJ-11008VP (50)	1.5	UC	2.34	702	562	468	401	351	281	234	176	156	140	112	93.6	80.2
	2.0	UC	2.64	792	634	528	453	396	317	264	198	176	158	127	106	90.5
	3.0	UC	3.14	942	754	628	538	471	377	314	236	209	188	151	126	108
	4.0	UC	3.55	1065	852	710	609	533	426	355	266	237	213	170	142	122
	5.0	XC	3.90	1170	936	780	669	585	468	390	293	260	234	187	156	134
	6.0	XC	4.22	1266	1013	844	723	633	506	422	317	281	253	203	169	145
	7.0	XC	4.51	1353	1082	902	773	677	541	451	338	301	271	216	180	155
APTJ-11010VP (50)	1.5	UC	2.90	870	696	580	497	435	348	290	218	193	174	139	116	99.4
	2.0	UC	3.28	984	787	656	562	492	394	328	246	219	197	157	131	112
	3.0	UC	3.92	1176	941	784	672	588	470	392	294	261	235	188	157	134
	4.0	UC	4.45	1335	1068	890	763	668	534	445	334	297	267	214	178	153
	5.0	XC	4.91	1473	1178	982	842	737	589	491	368	327	295	236	196	168
	6.0	XC	5.32	1596	1277	1064	912	798	638	532	399	355	319	255	213	182
	7.0	XC	5.69	1707	1366	1138	975	854	683	569	427	379	341	273	228	195
APTJ-11012VP (50)	1.5	UC	3.51	1053	842	702	602	527	421	351	263	234	211	168	140	120
	2.0	UC	3.97	1191	953	794	681	596	476	397	298	265	238	191	159	136
	3.0	UC	4.71	1413	1130	942	807	707	565	471	353	314	283	226	188	161
	4.0	XC	5.31	1593	1274	1062	910	797	637	531	398	354	319	255	212	182
	5.0	XC	5.84	1752	1402	1168	1001	876	701	584	438	389	350	280	234	200
	6.0	XC	6.31	1893	1514	1262	1082	947	757	631	473	421	379	303	252	216
	7.0	XC	6.73	2019	1615	1346	1154	1010	808	673	505	449	404	323	269	231

**Note:** Always double check your application rates. Droplet size classification shown is based on ISO 25358. Droplet size classification standard is subject to change. Tabulations are based on spraying water at 21°C. See technical information (pages 177–202) for droplet size classification, useful formulas and other technical information. Due to the unique design of APTJ, flow and application rate values on this chart are specific to APTJ and differ from other flat spray rate charts.

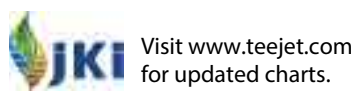



BROADCAST NOZZLES

## Typical Applications



**HERBICIDE**  
CONTACT  
**EXCELLENT**  
SYSTEMIC  
**VERY GOOD**



**FUNGICIDE**  
CONTACT  
**EXCELLENT**  
SYSTEMIC  
**VERY GOOD**



**INSECTICIDE**  
CONTACT  
**EXCELLENT**  
SYSTEMIC  
**VERY GOOD**



**FERTILIZER**  
BROADCAST  
**EXCELLENT**



**DRIFT CONTROL**  
**GOOD**



**PWM APPROVED**



## FEATURES

- Tapered edge wide angle flat spray pattern for uniform coverage in broadcast spraying.
- 15° attack angle for better canopy penetration.
- Available in polymer and ceramic for more flexibility on the choice according to different pesticide formulation.
- Large, rounded internal passage to minimize clogging.
- Polymer material used on the TT-VP provides a good wear life and acid resistance.
- The TT-VK polypropylene body provides excellent acid resistance and the ceramic pre- and exit orifice offers improved wear life.
- Unique internal configuration means substantially longer wear life.
- Available in eleven VisiFlo® Polymer (VP) and nine VisiFlo ceramic (VK) capacities.
- Automatic spray alignment with Quick TeeJet® cap and gasket 114441A-\*CELR (01 to 08) or 114502A-\*CELR (10 and 12). Reference page 118 for more information.

## SPRAY PATTERN

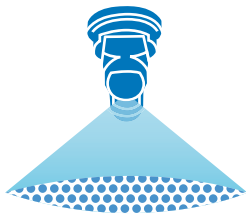

## DROPLET SIZE CLASSIFICATION

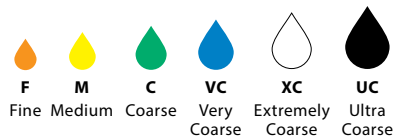

## OPTIMUM SPRAY HEIGHT

ANGLE	50 cm SPACING HEIGHT
110°	50 cm

## RECOMMENDED PRESSURE RANGE



## MATERIALS AVAILABLE



## HOW TO ORDER

Polymer with VisiFlo color-coding

**TT 1 1 0 0 1 - V P**

Tip Type	Spray Angle	Capacity Size	Material Code
----------	-------------	---------------	---------------

Polymer with VisiFlo color-coding, includes Quick TeeJet cap and gasket\*

**TT 1 1 0 0 2 - V P - C E**

Tip Type	Spray Angle	Capacity Size	Material Code	Cap and Gasket Included
----------	-------------	---------------	---------------	-------------------------

\*Reference page 118 for more caps information.



# Turbo TeeJet® WIDE ANGLE FLAT SPRAY



BROADCAST NOZZLES

TIP PART NO. (STRAINER MESH SIZE)	bar	DROP SIZE	CAPACITY ONE TIP IN l/min	APPLICATION RATE FOR 50 cm SPRAY TIP SPACING												
				l/ha												
				4 km/h	5 km/h	6 km/h	7 km/h	8 km/h	10 km/h	12 km/h	16 km/h	18 km/h	20 km/h	25 km/h	30 km/h	35 km/h
TT11001 (100)	1.0	VC	0.23	69.0	55.2	46.0	39.4	34.5	27.6	23.0	17.3	15.3	13.8	11.0	9.2	7.9
	2.0	C	0.32	96.0	76.8	64.0	54.9	48.0	38.4	32.0	24.0	21.3	19.2	15.4	12.8	11.0
	3.0	M	0.39	117	93.6	78.0	66.9	58.5	46.8	39.0	29.3	26.0	23.4	18.7	15.6	13.4
	4.0	M	0.45	135	108	90.0	77.1	67.5	54.0	45.0	33.8	30.0	27.0	21.6	18.00	15.4
	5.0	F	0.50	150	120	100	85.7	75.0	60.0	50.0	37.5	33.3	30.0	24.0	20.0	17.1
6.0	F	0.55	165	132	110	94.3	82.5	66.0	55.0	41.3	36.7	33.0	26.4	22.0	18.9	
TT110015 (100)	1.0	VC	0.34	102	81.6	68.0	58.3	51.0	40.8	34.0	25.5	22.7	20.4	16.3	13.6	11.7
	2.0	C	0.48	144	115	96.0	82.3	72.0	57.6	48.0	36.0	32.0	28.8	23.0	19.2	16.5
	3.0	M	0.59	177	142	118	101	88.5	70.8	59.0	44.3	39.3	35.4	28.3	23.6	20.2
	4.0	M	0.68	204	163	136	117	102	81.6	68.0	51.0	45.3	40.8	32.6	27.2	23.3
	5.0	M	0.76	228	182	152	130	114	91.2	76.0	57.0	50.7	45.6	36.5	30.4	26.1
6.0	F	0.83	249	199	166	142	125	99.6	83.0	62.3	55.3	49.8	39.8	33.2	28.5	
TT11002 (50)	1.0	VC	0.46	138	110	92.0	78.9	69.0	55.2	46.0	34.5	30.7	27.6	22.1	18.4	15.8
	2.0	C	0.65	195	156	130	111	97.5	78.0	65.0	48.8	43.3	39.0	31.2	26.0	22.3
	3.0	M	0.79	237	190	158	135	119	94.8	79.0	59.3	52.7	47.4	37.9	31.6	27.1
	4.0	M	0.91	273	218	182	156	137	109	91.0	68.3	60.7	54.6	43.7	36.4	31.2
	5.0	M	1.02	306	245	204	175	153	122	102	76.5	68.0	61.2	49.0	40.8	35.0
6.0	F	1.12	336	269	224	192	168	134	112	84.0	74.7	67.2	53.8	44.8	38.4	
TT110025 (50)	1.0	VC	0.57	171	137	114	97.7	85.5	68.4	57.0	42.8	38.0	34.2	27.4	22.8	19.5
	2.0	C	0.81	243	194	162	139	122	97.2	81.0	60.8	54.0	48.6	38.9	32.4	27.8
	3.0	M	0.99	297	238	198	170	149	119	99.0	74.3	66.0	59.4	47.5	39.6	33.9
	4.0	M	1.14	342	274	228	195	171	137	114	85.5	76.0	68.4	54.7	45.6	39.1
	5.0	M	1.28	384	307	256	219	192	154	128	96.0	85.3	76.8	61.4	51.2	43.9
6.0	F	1.40	420	336	280	240	210	168	140	105	93.3	84.0	67.2	56.0	48.0	
TT11003 (50)	1.0	XC	0.68	204	163	136	117	102	81.6	68.0	51.0	45.3	40.8	32.6	27.2	23.3
	2.0	C	0.96	288	230	192	165	144	115	96.0	72.0	64.0	57.6	46.1	38.4	32.9
	3.0	M	1.18	354	283	236	202	177	142	118	88.5	78.7	70.8	56.6	47.2	40.5
	4.0	M	1.36	408	326	272	233	204	163	136	102	90.7	81.6	65.3	54.4	46.6
	5.0	M	1.52	456	365	304	261	228	182	152	114	101	91.2	73.0	60.8	52.1
6.0	F	1.67	501	401	334	286	251	200	167	125	111	100	80.2	66.8	57.3	
TT11004 (50)	1.0	XC	0.91	273	218	182	156	137	109	91.0	68.3	60.7	54.6	43.7	36.4	31.2
	2.0	C	1.29	387	310	258	221	194	155	129	96.8	86.0	77.4	61.9	51.6	44.2
	3.0	M	1.58	474	379	316	271	237	190	158	119	105	94.8	75.8	63.2	54.2
	4.0	M	1.82	546	437	364	312	273	218	182	137	121	109	87.4	72.8	62.4
	5.0	M	2.04	612	490	408	350	306	245	204	153	136	122	97.9	81.6	69.9
6.0	F	2.23	669	535	446	382	335	268	223	167	149	134	107	89.2	76.5	
TT11005 (50)	1.0	XC	1.14	342	274	228	195	171	137	114	85.5	76.0	68.4	54.7	45.6	39.1
	2.0	C	1.61	483	386	322	276	242	193	161	121	107	96.6	77.3	64.4	55.2
	3.0	M	1.97	591	473	394	338	296	236	197	148	131	118	94.6	78.8	67.5
	4.0	M	2.27	681	545	454	389	341	272	227	170	151	136	109	90.8	77.8
	5.0	M	2.54	762	610	508	435	381	305	254	191	169	152	122	102	87.1
6.0	F	2.79	837	670	558	478	419	335	279	209	186	167	134	112	95.7	
TT11006 (50)	1.0	XC	1.37	411	329	274	235	206	164	137	103	91.3	82.2	65.8	54.8	47.0
	2.0	C	1.94	582	466	388	333	291	233	194	146	129	116	93.1	77.6	66.5
	3.0	M	2.37	711	569	474	406	356	284	237	178	158	142	114	94.8	81.3
	4.0	M	2.74	822	658	548	470	411	329	274	206	183	164	132	110	93.9
	5.0	M	3.06	918	734	612	525	459	367	306	230	204	184	147	122	105
6.0	F	3.35	1005	804	670	574	503	402	335	251	223	201	161	134	115	
TT11008 (50)	1.0	XC	1.82	546	437	364	312	273	218	182	137	121	109	87.4	72.8	62.4
	2.0	VC	2.58	774	619	516	442	387	310	258	194	172	155	124	103	88.5
	3.0	M	3.16	948	758	632	542	474	379	316	237	211	190	152	126	108
	4.0	M	3.65	1095	876	730	626	548	438	365	274	243	219	175	146	125
	5.0	M	4.08	1224	979	816	699	612	490	408	306	272	245	196	163	140
6.0	F	4.47	1341	1073	894	766	671	536	447	335	298	268	215	179	153	
TT11010	1.0	UC	2.28	684	547	456	391	342	274	228	171	152	137	109	91.2	78.2
	2.0	XC	3.23	969	775	646	554	485	388	323	242	215	194	155	129	111
	3.0	VC	3.95	1185	948	790	677	593	474	395	296	263	237	190	158	135
	4.0	C	4.56	1368	1094	912	782	684	547	456	342	304	274	219	182	156
	5.0	C	5.10	1530	1224	1020	874	765	612	510	383	340	306	245	204	175
6.0	M	5.59	1677	1342	1118	958	839	671	559	419	373	335	268	224	192	
TT11012	1.0	UC	2.73	819	655	546	468	410	328	273	205	182	164	131	109	93.6
	2.0	XC	3.86	1158	926	772	662	579	463	386	290	257	232	185	154	132
	3.0	VC	4.73	1419	1135	946	811	710	568	473	355	315	284	227	189	162
	4.0	VC	5.46	1638	1310	1092	936	819	655	546	410	364	328	262	218	187
	5.0	C	6.11	1833	1466	1222	1047	917	733	611	458	407	367	293	244	209
6.0	C	6.69	2007	1606	1338	1147	1004	803	669	502	446	401	321	268	229	

Note: Always double check your application rates. Droplet size classification shown is based on ISO 25358. Droplet size classification standard is subject to change. Tabulations are based on spraying water at 21°C. See technical information (pages 179-202) for droplet size classification, useful formulas and other technical information.

## LERAP RATINGS

TIP & CAPACITY	PRESSURE (bar)	STAR RATING
TT11004	1.5-2	★★
TT11005	1	★★★
	1.5-3	★★



Visit [www.teejet.com](http://www.teejet.com) for updated charts.

## Typical Applications



**HERBICIDE**  
SOIL APPLIED  
**VERY GOOD**  
CONTACT  
**EXCELLENT**  
SYSTEMIC  
**VERY GOOD**



**FUNGICIDE**  
CONTACT  
**GOOD**  
SYSTEMIC  
**VERY GOOD**



**INSECTICIDE**  
CONTACT  
**VERY GOOD**  
SYSTEMIC  
**EXCELLENT**



**DRIFT CONTROL**  
**VERY GOOD**



## FEATURES

- Tapered edge flat spray angle pattern with air induction technology offers better drift management.
- Produces large air-filled droplets through a Venturi air aspirator.
- Unique UHMWPE polymer material used on the AIXR-VP adds improved wear life and better acid resistance.
- The AIXR-VK polypropylene body provides excellent acid resistance, and the ceramic pre- and exit orifice offers improved wear life.
- Compact size to prevent tip damage.
- Removable pre-orifice.
- Available in nine VisiFlo® Polymer (VP) and seven VisiFlo ceramic (VK) capacities.
- Automatic spray alignment with Quick TeeJet® cap and gasket 114441A-\*CELR (015 to 06) or 114443A-\*CELR (08 and 10). Reference page 118 for more information.

## SPRAY PATTERN

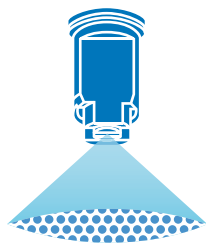

## DROPLET SIZE CLASSIFICATION

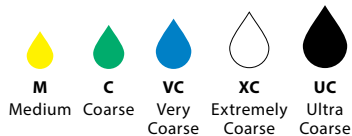

## OPTIMUM SPRAY HEIGHT

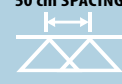
 <b>ANGLE</b>	 <b>HEIGHT</b>
110°	50 cm

## RECOMMENDED PRESSURE RANGE



## MATERIALS AVAILABLE



## HOW TO ORDER

Polymer with VisiFlo color-coding

**AIXR11004VP**

Tip Type	Spray Angle	Capacity Size	Material Code
----------	-------------	---------------	---------------

Polymer with VisiFlo color-coding, includes Quick TeeJet cap and gasket\*

**AIXR11003VP-CE**

Tip Type	Spray Angle	Capacity Size	Material Code	Cap and Gasket Included
----------	-------------	---------------	---------------	-------------------------

\*Reference page 118 for more caps information.

TIP PART NO. (STRAINER MESH SIZE)	bar	DROP SIZE	CAPACITY ONE TIP IN l/min	APPLICATION RATE FOR 50 cm SPRAY TIP SPACING												
				l/ha												
				4 km/h	5 km/h	6 km/h	7 km/h	8 km/h	10 km/h	12 km/h	16 km/h	18 km/h	20 km/h	25 km/h	30 km/h	35 km/h
AIXR110015 (100)	1.0	VC	0.34	102	81.6	68.0	58.3	51.0	40.8	34.0	25.5	22.7	20.4	16.3	13.6	11.7
	2.0	C	0.48	144	115	96.0	82.3	72.0	57.6	48.0	36.0	32.0	28.8	23.0	19.2	16.5
	3.0	C	0.59	177	142	118	101	88.5	70.8	59.0	44.3	39.3	35.4	28.3	23.6	20.2
	4.0	M	0.68	204	163	136	117	102	81.6	68.0	51.0	45.3	40.8	32.6	27.2	23.3
	5.0	M	0.76	228	182	152	130	114	91.2	76.0	57.0	50.7	45.6	36.5	30.4	26.1
	6.0	M	0.83	249	199	166	142	125	99.6	83.0	62.3	55.3	49.8	39.8	33.2	28.5
AIXR11002 (50)	1.0	XC	0.46	138	110	92.0	78.9	69.0	55.2	46.0	34.5	30.7	27.6	22.1	18.4	15.8
	2.0	VC	0.65	195	156	130	111	97.5	78.0	65.0	48.8	43.3	39.0	31.2	26.0	22.3
	3.0	C	0.79	237	190	158	135	119	94.8	79.0	59.3	52.7	47.4	37.9	31.6	27.1
	4.0	M	0.91	273	218	182	156	137	109	91.0	68.3	60.7	54.6	43.7	36.4	31.2
	5.0	M	1.02	306	245	204	175	153	122	102	76.5	68.0	61.2	49.0	40.8	35.0
	6.0	M	1.12	336	269	224	192	168	134	112	84.0	74.7	67.2	53.8	44.8	38.4
AIXR110025 (50)	1.0	XC	0.57	171	137	114	97.7	85.5	68.4	57.0	42.8	38.0	34.2	27.4	22.8	19.5
	2.0	VC	0.81	243	194	162	139	122	97.2	81.0	60.8	54.0	48.6	38.9	32.4	27.8
	3.0	C	0.99	297	238	198	170	149	119	99.0	74.3	66.0	59.4	47.5	39.6	33.9
	4.0	M	1.14	342	274	228	195	171	137	114	85.5	76.0	68.4	54.7	45.6	39.1
	5.0	M	1.28	384	307	256	219	192	154	128	96.0	85.3	76.8	61.4	51.2	43.9
	6.0	M	1.40	420	336	280	240	210	168	140	105	93.3	84.0	67.2	56.0	48.0
AIXR11003 (50)	1.0	XC	0.68	204	163	136	117	102	81.6	68.0	51.0	45.3	40.8	32.6	27.2	23.3
	2.0	VC	0.96	288	230	192	165	144	115	96.0	72.0	64.0	57.6	46.1	38.4	32.9
	3.0	C	1.18	354	283	236	202	177	142	118	88.5	78.7	70.8	56.6	47.2	40.5
	4.0	M	1.36	408	326	272	233	204	163	136	102	90.7	81.6	65.3	54.4	46.6
	5.0	M	1.52	456	365	304	261	228	182	152	114	101	91.2	73.0	60.8	52.1
	6.0	M	1.67	501	401	334	286	251	200	167	125	111	100	80.2	66.8	57.3
AIXR11004 (50)	1.0	XC	0.91	273	218	182	156	137	109	91.0	68.3	60.7	54.6	43.7	36.4	31.2
	2.0	VC	1.29	387	310	258	221	194	155	129	96.8	86.0	77.4	61.9	51.6	44.2
	3.0	C	1.58	474	379	316	271	237	190	158	119	105	94.8	75.8	63.2	54.2
	4.0	C	1.82	546	437	364	312	273	218	182	137	121	109	87.4	72.8	62.4
	5.0	M	2.04	612	490	408	350	306	245	204	153	136	122	97.9	81.6	69.9
	6.0	M	2.23	669	535	446	382	335	268	223	167	149	134	107	89.2	76.5
AIXR11005 (50)	1.0	XC	1.14	342	274	228	195	171	137	114	85.5	76.0	68.4	54.7	45.6	39.1
	2.0	VC	1.61	483	386	322	276	242	193	161	121	107	96.6	77.3	64.4	55.2
	3.0	VC	1.97	591	473	394	338	296	236	197	148	131	118	94.6	78.8	67.5
	4.0	C	2.27	681	545	454	389	341	272	227	170	151	136	109	90.8	77.8
	5.0	M	2.54	762	610	508	435	381	305	254	191	169	152	122	102	87.1
	6.0	M	2.79	837	670	558	478	419	335	279	209	186	167	134	112	95.7
AIXR11006 (50)	1.0	XC	1.37	411	329	274	235	206	164	137	103	91.3	82.2	65.8	54.8	47.0
	2.0	VC	1.94	582	466	388	333	291	233	194	146	129	116	93.1	77.6	66.5
	3.0	VC	2.37	711	569	474	406	356	284	237	178	158	142	114	94.8	81.3
	4.0	C	2.74	822	658	548	470	411	329	274	206	183	164	132	110	93.9
	5.0	C	3.06	918	734	612	525	459	367	306	230	204	184	147	122	105
	6.0	C	3.35	1005	804	670	574	503	402	335	251	223	201	161	134	115
AIXR11008 (50)	1.0	UC	1.82	546	437	364	312	273	218	182	137	121	109	87.4	72.8	62.4
	2.0	XC	2.58	774	619	516	442	387	310	258	194	172	155	124	103	88.5
	3.0	VC	3.16	948	758	632	542	474	379	316	237	211	190	152	126	108
	4.0	VC	3.65	1095	876	730	626	548	438	365	274	243	219	175	146	125
	5.0	C	4.08	1224	979	816	699	612	490	408	306	272	245	196	163	140
	6.0	C	4.47	1341	1073	894	766	671	536	447	335	298	268	215	179	153
AIXR11010	1.0	UC	2.28	684	547	456	391	342	274	228	171	152	137	109	91.2	78.2
	2.0	XC	3.23	969	775	646	554	485	388	323	242	215	194	155	129	111
	3.0	VC	3.95	1185	948	790	677	593	474	395	296	263	237	190	158	135
	4.0	VC	4.56	1368	1094	912	782	684	547	456	342	304	274	219	182	156
	5.0	VC	5.10	1530	1224	1020	874	765	612	510	383	340	306	245	204	175
	6.0	C	5.59	1677	1342	1118	958	839	671	559	419	373	335	268	224	192

**Note:** Always double check your application rates. Droplet size classification shown is based on ISO 25358. Droplet size classification standard is subject to change. Tabulations are based on spraying water at 21°C. See technical information (pages 179–202) for droplet size classification, useful formulas and other technical information.

### LERAP RATINGS

TIP & CAPACITY	PRESSURE (bar)	STAR RATING	TIP & CAPACITY	PRESSURE (bar)	STAR RATING
AIXR110025VP	1.0–1.4	★★★★	AIXR11005VP	1.0–2.9	★★★★
	1.5–5.0	★★★		3.0–5.0	★★★
AIXR11003VP	1.0–1.4	★★★★	AIXR11006VP	1.0–3.9	★★★★
	1.5–5.0	★★★		4.0–5.0	★★★
AIXR11004VP	1.0–1.7	★★★★			
	1.75–5.0	★★★			



Visit [www.teejet.com](http://www.teejet.com) for updated charts.



## Typical Applications



**HERBICIDE**  
SOIL APPLIED  
**VERY GOOD**  
SYSTEMIC  
**EXCELLENT**



**FUNGICIDE**  
SYSTEMIC  
**GOOD**



**INSECTICIDE**  
SYSTEMIC  
**VERY GOOD**



**FERTILIZER**  
BROADCAST  
**VERY GOOD**



**DRIFT CONTROL**  
**EXCELLENT**



## FEATURES

- Stainless steel insert produces a tapered edge flat spray pattern for uniform coverage in broadcast spraying.
- Air induction spray tip, producing large air-filled droplets through the use of a Venturi air aspirator more resistant to drift.
- Available in 80° or 110° spray angles with a Polymer insert holder and pre-orifice with VisiFlo® color-coding.
- Available in eight 110° versions, and seven 80° versions.
- Automatic spray alignment with 114443A-\*CELR Quick TeeJet® cap and gasket. Reference page 118 for more information.

## SPRAY PATTERN

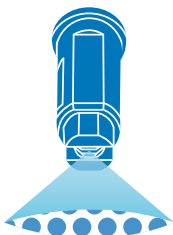

## DROPLET SIZE CLASSIFICATION



## OPTIMUM SPRAY HEIGHT

ANGLE	50 cm SPACING HEIGHT
80°	75 cm
110°	50 cm

## RECOMMENDED PRESSURE RANGE



## MATERIALS AVAILABLE

**VS** STAINLESS STEEL

## HOW TO ORDER

Stainless Steel with VisiFlo color-coding

**A 1 1 1 0 0 4 - V S**

Tip Type    Spray Angle    Capacity Size    Material Code

Stainless Steel with VisiFlo color-coding

**A 1 8 0 0 4 V S**

Tip Type    Spray Angle    Capacity Size    Material Code

TIP PART NO. (STRAINER MESH SIZE)	bar	DROP SIZE		CAPACITY ONE TIP IN l/min	APPLICATION RATE FOR 50 cm SPRAY TIP SPACING												
		80°	110°		l/ha												
					4 km/h	5 km/h	6 km/h	7 km/h	8 km/h	10 km/h	12 km/h	16 km/h	18 km/h	20 km/h	25 km/h	30 km/h	35 km/h
AI80015 AI110015 (100)	2.0	XC	XC	0.48	144	115	96.0	82.3	72.0	57.6	48.0	36.0	32.0	28.8	23.0	19.2	16.5
	3.0	VC	VC	0.59	177	142	118	101	88.5	70.8	59.0	44.3	39.3	35.4	28.3	23.6	20.2
	4.0	VC	VC	0.68	204	163	136	117	102	81.6	68.0	51.0	45.3	40.8	32.6	27.2	23.3
	5.0	VC	C	0.76	228	182	152	130	114	91.2	76.0	57.0	50.7	45.6	36.5	30.4	26.1
	6.0	C	C	0.83	249	199	166	142	125	99.6	83.0	62.3	55.3	49.8	39.8	33.2	28.5
	7.0	C	C	0.90	270	216	180	154	135	108	90.0	67.5	60.0	54.0	43.2	36.0	30.9
8.0	C	M	0.96	288	230	192	165	144	115	96.0	72.0	64.0	57.6	46.1	38.4	32.9	
AI8002 AI11002 (50)	2.0	XC	XC	0.65	195	156	130	111	97.5	78.0	65.0	48.8	43.3	39.0	31.2	26.0	22.3
	3.0	XC	VC	0.79	237	190	158	135	119	94.8	79.0	59.3	52.7	47.4	37.9	31.6	27.1
	4.0	VC	VC	0.91	273	218	182	156	137	109	91.0	68.3	60.7	54.6	43.7	36.4	31.2
	5.0	VC	C	1.02	306	245	204	175	153	122	102	76.5	68.0	61.2	49.0	40.8	35.0
	6.0	C	C	1.12	336	269	224	192	168	134	112	84.0	74.7	67.2	53.8	44.8	38.4
	7.0	C	C	1.21	363	290	242	207	182	145	121	90.8	80.7	72.6	58.1	48.4	41.5
8.0	C	M	1.29	387	310	258	221	194	155	129	96.8	86.0	77.4	61.9	51.6	44.2	
AI80025 AI110025 (50)	2.0	XC	XC	0.81	243	194	162	139	122	97.2	81.0	60.8	54.0	48.6	38.9	32.4	27.8
	3.0	XC	VC	0.99	297	238	198	170	149	119	99.0	74.3	66.0	59.4	47.5	39.6	33.9
	4.0	VC	VC	1.14	342	274	228	195	171	137	114	85.5	76.0	68.4	54.7	45.6	39.1
	5.0	VC	C	1.28	384	307	256	219	192	154	128	96.0	85.3	76.8	61.4	51.2	43.9
	6.0	C	C	1.40	420	336	280	240	210	168	140	105	93.3	84.0	67.2	56.0	48.0
	7.0	C	C	1.51	453	362	302	259	227	181	151	113	101	90.6	72.5	60.4	51.8
8.0	C	M	1.62	486	389	324	278	243	194	162	122	108	97.2	77.8	64.8	55.5	
AI8003 AI11003 (50)	2.0	XC	XC	0.96	288	230	192	165	144	115	96.0	72.0	64.0	57.6	46.1	38.4	32.9
	3.0	XC	VC	1.18	354	283	236	202	177	142	118	88.5	78.7	70.8	56.6	47.2	40.5
	4.0	VC	VC	1.36	408	326	272	233	204	163	136	102	90.7	81.6	65.3	54.4	46.6
	5.0	VC	C	1.52	456	365	304	261	228	182	152	114	101	91.2	73.0	60.8	52.1
	6.0	C	C	1.67	501	401	334	286	251	200	167	125	111	100	80.2	66.8	57.3
	7.0	C	C	1.80	540	432	360	309	270	216	180	135	120	108	86.4	72.0	61.7
8.0	C	M	1.93	579	463	386	331	290	232	193	145	129	116	92.6	77.2	66.2	
AI8004 AI11004 (50)	2.0	XC	XC	1.29	387	310	258	221	194	155	129	96.8	86.0	77.4	61.9	51.6	44.2
	3.0	XC	VC	1.58	474	379	316	271	237	190	158	119	105	94.8	75.8	63.2	54.2
	4.0	VC	VC	1.82	546	437	364	312	273	218	182	137	121	109	87.4	72.8	62.4
	5.0	VC	C	2.04	612	490	408	350	306	245	204	153	136	122	97.9	81.6	69.9
	6.0	C	C	2.23	669	535	446	382	335	268	223	167	149	134	107	89.2	76.5
	7.0	C	C	2.41	723	578	482	413	362	289	241	181	161	145	116	96.4	82.6
8.0	C	M	2.58	774	619	516	442	387	310	258	194	172	155	124	103	88.5	
AI8005 AI11005 (50)	2.0	XC	XC	1.61	483	386	322	276	242	193	161	121	107	96.6	77.3	64.4	55.2
	3.0	XC	VC	1.97	591	473	394	338	296	236	197	148	131	118	94.6	78.8	67.5
	4.0	VC	VC	2.27	681	545	454	389	341	272	227	170	151	136	109	90.8	77.8
	5.0	VC	VC	2.54	762	610	508	435	381	305	254	191	169	152	122	102	87.1
	6.0	VC	C	2.79	837	670	558	478	419	335	279	209	186	167	134	112	95.7
	7.0	C	C	3.01	903	722	602	516	452	361	301	226	201	181	144	120	103
8.0	C	C	3.22	966	773	644	552	483	386	322	242	215	193	155	129	110	
AI8006 AI11006 (50)	2.0	XC	XC	1.94	582	466	388	333	291	233	194	146	129	116	93.1	77.6	66.5
	3.0	XC	VC	2.37	711	569	474	406	356	284	237	178	158	142	114	94.8	81.3
	4.0	VC	VC	2.74	822	658	548	470	411	329	274	206	183	164	132	110	93.9
	5.0	VC	VC	3.06	918	734	612	525	459	367	306	230	204	184	147	122	105
	6.0	VC	C	3.35	1005	804	670	574	503	402	335	251	223	201	161	134	115
	7.0	VC	C	3.62	1086	869	724	621	543	434	362	272	241	217	174	145	124
8.0	VC	C	3.87	1161	929	774	663	581	464	387	290	258	232	186	155	133	
AI11008 (50)	2.0		XC	2.58	774	619	516	442	387	310	258	194	172	155	124	103	88.5
	3.0		XC	3.16	948	758	632	542	474	379	316	237	211	190	152	126	108
	4.0		VC	3.65	1095	876	730	626	548	438	365	274	243	219	175	146	125
	5.0		VC	4.08	1224	979	816	699	612	490	408	306	272	245	196	163	140
	6.0		VC	4.47	1341	1073	894	766	671	536	447	335	298	268	215	179	153
	7.0		VC	4.83	1449	1159	966	828	725	580	483	362	322	290	232	193	166
8.0		C	5.16	1548	1238	1032	885	774	619	516	387	344	310	248	206	177	

**Note:** Always double check your application rates. Droplet size classification shown is based on ISO 25358. Droplet size classification standard is subject to change. Tabulations are based on spraying water at 21°C. See technical information (pages 179–202) for droplet size classification, useful formulas and other technical information.

### LERAP RATINGS

TIP & CAPACITY	PRESSURE (bar)	STAR RATING	TIP & CAPACITY	PRESSURE (bar)	STAR RATING
AI11002	2.0–3.0	★★★	AI11004	2.0–3.0	★★★
	Max. 4.0	★★		4.0–6.0	★★
AI110025	Max. 2.0	★★★	AI11005	2.0–3.0 & 5.0	★★★
	3.0–4.0	★★		4.0 & 6.0	★★
AI11003	2.0–3.0	★★★			
	4.0–6.0	★★			



Visit [www.teejet.com](http://www.teejet.com) for updated charts.

## Typical Applications



**HERBICIDE**  
SOIL APPLIED  
**VERY GOOD**  
SYSTEMIC  
**EXCELLENT**



**FUNGICIDE**  
SYSTEMIC  
**GOOD**



**INSECTICIDE**  
SYSTEMIC  
**VERY GOOD**



**FERTILIZER**  
BROADCAST  
**VERY GOOD**



**DRIFT CONTROL**  
**EXCELLENT**



## FEATURES

- Produces a 110° tapered edge flat spray pattern for uniform coverage in broadcast spraying applications.
- Air induction spray tip, producing large air-filled droplets through the use of a Venturi air aspirator more resistant to drift.
- AI TeeJet nozzle molded into Quick TeeJet® cap provides automatic spray alignment.
- Available with a polymer insert holder with stainless steel (015–15 capacities), ceramic (025–05 capacities) or polymer (02–10 capacities) inserts.
- Includes tightly fitting gasket that stays put and assures a good seal. Replacement gasket part number: CP19438-1-EPR

## SPRAY PATTERN



## DROPLET SIZE CLASSIFICATION

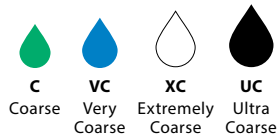

## OPTIMUM SPRAY HEIGHT

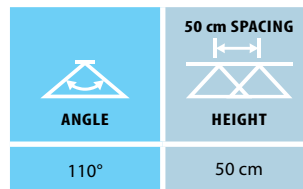

## RECOMMENDED PRESSURE RANGE



## MATERIALS AVAILABLE

- VS** STAINLESS STEEL
- VP** POLYMER
- VK** CERAMIC

## HOW TO ORDER

Stainless Steel with VisiFlo® color-coding

**A I C 1 1 0 0 4 - V S**

Tip Type	Spray Angle	Capacity Size	Material Code
----------	-------------	---------------	---------------

Ceramic with VisiFlo color-coding

**A I C 1 1 0 0 3 - V K**

Tip Type	Spray Angle	Capacity Size	Material Code
----------	-------------	---------------	---------------

Polymer with VisiFlo color-coding

**A I C 1 1 0 0 3 - V P**

Tip Type	Spray Angle	Capacity Size	Material Code
----------	-------------	---------------	---------------



TIP PART NO. (STRAINER MESH SIZE)	bar	DROP SIZE	CAPACITY ONE TIP IN l/min	APPLICATION RATE FOR 50 cm SPRAY TIP SPACING												
				l/ha												
				4 km/h	5 km/h	6 km/h	7 km/h	8 km/h	10 km/h	12 km/h	16 km/h	18 km/h	20 km/h	25 km/h	30 km/h	35 km/h
AIC110015 (100)	2.0	XC	0.48	144	115	96.0	82.3	72.0	57.6	48.0	36.0	32.0	28.8	23.0	19.2	16.5
	3.0	XC	0.59	177	142	118	101	88.5	70.8	59.0	44.3	39.3	35.4	28.3	23.6	20.2
	4.0	VC	0.68	204	163	136	117	102	81.6	68.0	51.0	45.3	40.8	32.6	27.2	23.3
	5.0	VC	0.76	228	182	152	130	114	91.2	76.0	57.0	50.7	45.6	36.5	30.4	26.1
	6.0	C	0.83	249	199	166	142	125	99.6	83.0	62.3	55.3	49.8	39.8	33.2	28.5
	7.0	C	0.90	270	216	180	154	135	108	90.0	67.5	60.0	54.0	43.2	36.0	30.9
8.0	C	0.96	288	230	192	165	144	115	96.0	72.0	64.0	57.6	46.1	38.4	32.9	
AIC11002 (50)	2.0	XC	0.65	195	156	130	111	97.5	78.0	65.0	48.8	43.3	39.0	31.2	26.0	22.3
	3.0	XC	0.79	237	190	158	135	119	94.8	79.0	59.3	52.7	47.4	37.9	31.6	27.1
	4.0	VC	0.91	273	218	182	156	137	109	91.0	68.3	60.7	54.6	43.7	36.4	31.2
	5.0	VC	1.02	306	245	204	175	153	122	102	76.5	68.0	61.2	49.0	40.8	35.0
	6.0	C	1.12	336	269	224	192	168	134	112	84.0	74.7	67.2	53.8	44.8	38.4
	7.0	C	1.21	363	290	242	207	182	145	121	90.8	80.7	72.6	58.1	48.4	41.5
8.0	C	1.29	387	310	258	221	194	155	129	96.8	86.0	77.4	61.9	51.6	44.2	
AIC110025 (50)	2.0	XC	0.81	243	194	162	139	122	97.2	81.0	60.8	54.0	48.6	38.9	32.4	27.8
	3.0	XC	0.99	297	238	198	170	149	119	99.0	74.3	66.0	59.4	47.5	39.6	33.9
	4.0	VC	1.14	342	274	228	195	171	137	114	85.5	76.0	68.4	54.7	45.6	39.1
	5.0	VC	1.28	384	307	256	219	192	154	128	96.0	85.3	76.8	61.4	51.2	43.9
	6.0	C	1.40	420	336	280	240	210	168	140	105	93.3	84.0	67.2	56.0	48.0
	7.0	C	1.51	453	362	302	259	227	181	151	113	101	90.6	72.5	60.4	51.8
8.0	C	1.62	486	389	324	278	243	194	162	122	108	97.2	77.8	64.8	55.5	
AIC11003 (50)	2.0	XC	0.96	288	230	192	165	144	115	96.0	72.0	64.0	57.6	46.1	38.4	32.9
	3.0	XC	1.18	354	283	236	202	177	142	118	88.5	78.7	70.8	56.6	47.2	40.5
	4.0	VC	1.36	408	326	272	233	204	163	136	102	90.7	81.6	65.3	54.4	46.6
	5.0	VC	1.52	456	365	304	261	228	182	152	114	101	91.2	73.0	60.8	52.1
	6.0	C	1.67	501	401	334	286	251	200	167	125	111	100	80.2	66.8	57.3
	7.0	C	1.80	540	432	360	309	270	216	180	135	120	108	86.4	72.0	61.7
8.0	C	1.93	579	463	386	331	290	232	193	145	129	116	92.6	77.2	66.2	
AIC11004 (50)	2.0	XC	1.29	387	310	258	221	194	155	129	96.8	86.0	77.4	61.9	51.6	44.2
	3.0	XC	1.58	474	379	316	271	237	190	158	119	105	94.8	75.8	63.2	54.2
	4.0	VC	1.82	546	437	364	312	273	218	182	137	121	109	87.4	72.8	62.4
	5.0	VC	2.04	612	490	408	350	306	245	204	153	136	122	97.9	81.6	69.9
	6.0	C	2.23	669	535	446	382	335	268	223	167	149	134	107	89.2	76.5
	7.0	C	2.41	723	578	482	413	362	289	241	181	161	145	116	96.4	82.6
8.0	C	2.58	774	619	516	442	387	310	258	194	172	155	124	103	88.5	
AIC11005 (50)	2.0	XC	1.61	483	386	322	276	242	193	161	121	107	96.6	77.3	64.4	55.2
	3.0	XC	1.97	591	473	394	338	296	236	197	148	131	118	94.6	78.8	67.5
	4.0	VC	2.27	681	545	454	389	341	272	227	170	151	136	109	90.8	77.8
	5.0	VC	2.54	762	610	508	435	381	305	254	191	169	152	122	102	87.1
	6.0	C	2.79	837	670	558	478	419	335	279	209	186	167	134	112	95.7
	7.0	C	3.01	903	722	602	516	452	361	301	226	201	181	144	120	103
8.0	C	3.22	966	773	644	552	483	386	322	242	215	193	155	129	110	
AIC11006 (50)	2.0	XC	1.94	582	466	388	333	291	233	194	146	129	116	93.1	77.6	66.5
	3.0	XC	2.37	711	569	474	406	356	284	237	178	158	142	114	94.8	81.3
	4.0	VC	2.74	822	658	548	470	411	329	274	206	183	164	132	110	93.9
	5.0	VC	3.06	918	734	612	525	459	367	306	230	204	184	147	122	105
	6.0	VC	3.35	1005	804	670	574	503	402	335	251	223	201	161	134	115
	7.0	C	3.62	1086	869	724	621	543	434	362	272	241	217	174	145	124
8.0	C	3.87	1161	929	774	663	581	464	387	290	258	232	186	155	133	
AIC11008 (50)	2.0	XC	2.58	774	619	516	442	387	310	258	194	172	155	124	103	88.5
	3.0	XC	3.16	948	758	632	542	474	379	316	237	211	190	152	126	108
	4.0	VC	3.65	1095	876	730	626	548	438	365	274	243	219	175	146	125
	5.0	VC	4.08	1224	979	816	699	612	490	408	306	272	245	196	163	140
	6.0	VC	4.47	1341	1073	894	766	671	536	447	335	298	268	215	179	153
	7.0	VC	4.83	1449	1159	966	828	725	580	483	362	322	290	232	193	166
8.0	VC	5.16	1548	1238	1032	885	774	619	516	387	344	310	248	206	177	
AIC11010	2.0	UC	3.23	969	775	646	554	485	388	323	242	215	194	155	129	111
	3.0	XC	3.95	1185	948	790	677	593	474	395	296	263	237	190	158	135
	4.0	XC	4.56	1368	1094	912	782	684	547	456	342	304	274	219	182	156
	5.0	XC	5.10	1530	1224	1020	874	765	612	510	383	340	306	245	204	175
	6.0	VC	5.59	1677	1342	1118	958	839	671	559	419	373	335	268	224	192
	7.0	VC	6.03	1809	1447	1206	1034	905	724	603	452	402	362	289	241	207
8.0	VC	6.45	1935	1548	1290	1106	968	774	645	484	430	387	310	258	221	
AIC11015	2.0	UC	4.83	1449	1159	966	828	725	580	483	362	322	290	232	193	166
	3.0	XC	5.92	1776	1421	1184	1015	888	710	592	444	395	355	284	237	203
	4.0	XC	6.84	2052	1642	1368	1173	1026	821	684	513	456	410	328	274	235
	5.0	XC	7.64	2292	1834	1528	1310	1146	917	764	573	509	458	367	306	262
	6.0	VC	8.37	2511	2009	1674	1435	1256	1004	837	628	558	502	402	335	287
	7.0	VC	9.04	2712	2170	1808	1550	1356	1085	904	678	603	542	434	362	310
8.0	VC	9.67	2901	2321	1934	1658	1451	1160	967	725	645	580	464	387	332	

**Note:** Always double check your application rates. Droplet size classification shown is based on ISO 25358. Droplet size classification standard is subject to change. Tabulations are based on spraying water at 21°C. See technical information (pages 179–202) for droplet size classification, useful formulas and other technical information.

### LERAP RATINGS

TIP & CAPACITY	PRESSURE (bar)	STAR RATING	TIP & CAPACITY	PRESSURE (bar)	STAR RATING
AIC11002VP	2.0	★★★	AIC11004V AIC11004VK	2.0	★★★
	3.0	★★		3.0–5.0	★★
AIC110025VP AIC110025VK	2.0	★★★	AIC11005VP AIC11005VK	2.0	★★★
	3.0	★★		3.0–5.0	★★
AIC11003VP AIC11003VK	2.0	★★★			
	3.0–5.0	★★			



Visit [www.teejet.com](http://www.teejet.com) for updated charts.



BROADCAST NOZZLES

## Typical Applications



**HERBICIDE**  
SOIL APPLIED  
**EXCELLENT**  
SYSTEMIC  
**EXCELLENT**



**FERTILIZER**  
BROADCAST  
**EXCELLENT**



**DRIFT CONTROL**  
**EXCELLENT**



**PWM APPROVED**



## FEATURES

- 110° wide angle, air induction, tapered flat spray tip pattern based on the patented outlet orifice design of the original Turbo TeeJet® nozzle.
- Provides excellent drift control and produces less than 2% of driftable fines.
- Patented orifice design provides large, round passages to minimize plugging and improved wear life.
- Depending on the chemical, produces large air-filled droplets through a Venturi air aspirator resulting in less drift.
- Compact size to prevent tip damage.
- Removable pre-orifice.
- Available in nine VisiFlo® Polymer (VP) capacities.
- Automatic spray alignment with Quick TeeJet cap and gasket 115835A-\* - CELR (015-06), or 114502A (08-10). The 115835A exclusive cap allows for straight through assembly, no need to rotate 90° to insert into the cap. Reference page 118 for more caps information.

## SPRAY PATTERN

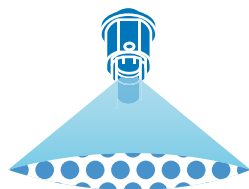

## DROPLET SIZE CLASSIFICATION

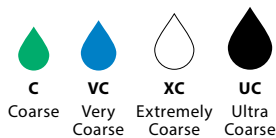

## OPTIMUM SPRAY HEIGHT

 <b>ANGLE</b> 110°	50 cm SPACING  <b>HEIGHT</b> 50 cm
--------------------------	---

## RECOMMENDED PRESSURE RANGE



## MATERIALS AVAILABLE



## HOW TO ORDER

Polymer with VisiFlo color-coding

**TTI11004-VP**

Tip Type	Spray Angle	Capacity Size	Material Code
----------	-------------	---------------	---------------

Polymer with VisiFlo color-coding, includes Quick TeeJet® cap and gasket\*

**TTI11003-VP-CE**

Tip Type	Spray Angle	Capacity Size	Material Code	Cap and Gasket Included
----------	-------------	---------------	---------------	-------------------------

\*Reference page 118 for more caps information.

# Turbo TeeJet® Induction FLAT SPRAY



BROADCAST NOZZLES

TIP PART NO. (STRAINER MESH SIZE)	bar	DROPSIZE	CAPACITY ONE TIP IN l/min	APPLICATION RATE FOR 50 cm SPRAY TIP SPACING												
				l/ha												
				4 km/h	5 km/h	6 km/h	7 km/h	8 km/h	10 km/h	12 km/h	16 km/h	18 km/h	20 km/h	25 km/h	30 km/h	35 km/h
TTI110001 (100)	1.0	UC	0.23	69.0	55.2	46.0	39.4	34.5	27.6	23.0	17.3	15.3	13.8	11.0	9.2	7.9
	2.0	UC	0.32	96.0	76.8	64.0	54.9	48.0	38.4	32.0	24.0	21.3	19.2	15.4	12.8	11.0
	3.0	XC	0.39	117	93.6	78.0	66.9	58.5	46.8	39.0	29.3	26.0	23.4	18.7	15.6	13.4
	4.0	VC	0.45	135	108	90.0	77.1	67.5	54.0	45.0	33.8	30.0	27.0	21.6	18.00	15.4
	5.0	VC	0.50	150	120	100	85.7	75.0	60.0	50.0	37.5	33.3	30.0	24.0	20.0	17.1
	6.0	VC	0.55	165	132	110	94.3	82.5	66.0	55.0	41.3	36.7	33.0	26.4	22.0	18.9
7.0	C	0.60	180	144	120	103	90.0	72.0	60.0	45.0	40.0	36.0	28.8	24.0	20.6	
TTI110015 (100)	1.0	UC	0.34	102	81.6	68.0	58.3	51.0	40.8	34.0	25.5	22.7	20.4	16.3	13.6	11.7
	2.0	UC	0.48	144	115	96.0	82.3	72.0	57.6	48.0	36.0	32.0	28.8	23.0	19.2	16.5
	3.0	XC	0.59	177	142	118	101	88.5	70.8	59.0	44.3	39.3	35.4	28.3	23.6	20.2
	4.0	XC	0.68	204	163	136	117	102	81.6	68.0	51.0	45.3	40.8	32.6	27.2	23.3
	5.0	VC	0.76	228	182	152	130	114	91.2	76.0	57.0	50.7	45.6	36.5	30.4	26.1
	6.0	VC	0.83	249	199	166	142	125	99.6	83.0	62.3	55.3	49.8	39.8	33.2	28.5
7.0	VC	0.90	270	216	180	154	135	108	90.0	67.5	60.0	54.0	43.2	36.0	30.9	
TTI11002 (50)	1.0	UC	0.46	138	110	92.0	78.9	69.0	55.2	46.0	34.5	30.7	27.6	22.1	18.4	15.8
	2.0	UC	0.65	195	156	130	111	97.5	78.0	65.0	48.8	43.3	39.0	31.2	26.0	22.3
	3.0	XC	0.79	237	190	158	135	119	94.8	79.0	59.3	52.7	47.4	37.9	31.6	27.1
	4.0	XC	0.91	273	218	182	156	137	109	91.0	68.3	60.7	54.6	43.7	36.4	31.2
	5.0	VC	1.02	306	245	204	175	153	122	102	76.5	68.0	61.2	49.0	40.8	35.0
	6.0	VC	1.12	336	269	224	192	168	134	112	84.0	74.7	67.2	53.8	44.8	38.4
7.0	VC	1.21	363	290	242	207	182	145	121	90.8	80.7	72.6	58.1	48.4	41.5	
TTI110025 (50)	1.0	UC	0.57	171	137	114	97.7	85.5	68.4	57.0	42.8	38.0	34.2	27.4	22.8	19.5
	2.0	UC	0.81	243	194	162	139	122	97.2	81.0	60.8	54.0	48.6	38.9	32.4	27.8
	3.0	XC	0.99	297	238	198	170	149	119	99.0	74.3	66.0	59.4	47.5	39.6	33.9
	4.0	XC	1.14	342	274	228	195	171	137	114	85.5	76.0	68.4	54.7	45.6	39.1
	5.0	VC	1.28	384	307	256	219	192	154	128	96.0	85.3	76.8	61.4	51.2	43.9
	6.0	VC	1.40	420	336	280	240	210	168	140	105	93.3	84.0	67.2	56.0	48.0
7.0	VC	1.51	453	362	302	259	227	181	151	113	101	90.6	72.5	60.4	51.8	
TTI11003 (50)	1.0	UC	0.68	204	163	136	117	102	81.6	68.0	51.0	45.3	40.8	32.6	27.2	23.3
	2.0	UC	0.96	288	230	192	165	144	115	96.0	72.0	64.0	57.6	46.1	38.4	32.9
	3.0	XC	1.18	354	283	236	202	177	142	118	88.5	78.7	70.8	56.6	47.2	40.5
	4.0	XC	1.36	408	326	272	233	204	163	136	102	90.7	81.6	65.3	54.4	46.6
	5.0	VC	1.52	456	365	304	261	228	182	152	114	101	91.2	73.0	60.8	52.1
	6.0	VC	1.67	501	401	334	286	251	200	167	125	111	100	80.2	66.8	57.3
7.0	VC	1.80	540	432	360	309	270	216	180	135	120	108	86.4	72.0	61.7	
TTI11004 (50)	1.0	UC	0.91	273	218	182	156	137	109	91.0	68.3	60.7	54.6	43.7	36.4	31.2
	2.0	UC	1.29	387	310	258	221	194	155	129	96.8	86.0	77.4	61.9	51.6	44.2
	3.0	XC	1.58	474	379	316	271	237	190	158	119	105	94.8	75.8	63.2	54.2
	4.0	XC	1.82	546	437	364	312	273	218	182	137	121	109	87.4	72.8	62.4
	5.0	VC	2.04	612	490	408	350	306	245	204	153	136	122	97.9	81.6	69.9
	6.0	VC	2.23	669	535	446	382	335	268	223	167	149	134	107	89.2	76.5
7.0	VC	2.41	723	578	482	413	362	289	241	181	161	145	116	96.4	82.6	
TTI11005 (50)	1.0	UC	1.14	342	274	228	195	171	137	114	85.5	76.0	68.4	54.7	45.6	39.1
	2.0	UC	1.61	483	386	322	276	242	193	161	121	107	96.6	77.3	64.4	55.2
	3.0	XC	1.97	591	473	394	338	296	236	197	148	131	118	94.6	78.8	67.5
	4.0	XC	2.27	681	545	454	389	341	272	227	170	151	136	109	90.8	77.8
	5.0	VC	2.54	762	610	508	435	381	305	254	191	169	152	122	102	87.1
	6.0	VC	2.79	837	670	558	478	419	335	279	209	186	167	134	112	95.7
7.0	VC	3.01	903	722	602	516	452	361	301	226	201	181	144	120	103	
TTI11006 (50)	1.0	UC	1.37	411	329	274	235	206	164	137	103	91.3	82.2	65.8	54.8	47.0
	2.0	UC	1.94	582	466	388	333	291	233	194	146	129	116	93.1	77.6	66.5
	3.0	XC	2.37	711	569	474	406	356	284	237	178	158	142	114	94.8	81.3
	4.0	XC	2.74	822	658	548	470	411	329	274	206	183	164	132	110	93.9
	5.0	VC	3.06	918	734	612	525	459	367	306	230	204	184	147	122	105
	6.0	VC	3.35	1005	804	670	574	503	402	335	251	223	201	161	134	115
7.0	C	3.62	1086	869	724	621	543	434	362	272	241	217	174	145	124	
TTI11008 (50)	1.0	UC	1.82	546	437	364	312	273	218	182	137	121	109	87.4	72.8	62.4
	2.0	UC	2.58	774	619	516	442	387	310	258	194	172	155	124	103	88.5
	3.0	XC	3.16	948	758	632	542	474	379	316	237	211	190	152	126	108
	4.0	XC	3.65	1095	876	730	626	548	438	365	274	243	219	175	146	125
	5.0	VC	4.08	1224	979	816	699	612	490	408	306	272	245	196	163	140
	6.0	VC	4.47	1341	1073	894	766	671	536	447	335	298	268	215	179	153
7.0	C	4.83	1449	1159	966	828	725	580	483	362	322	290	232	193	166	
TTI11010	1.0	UC	2.28	684	547	456	391	342	274	228	171	152	137	109	91.2	78.2
	2.0	UC	4.83	1449	775	966	554	725	580	483	362	322	290	232	193	166
	3.0	XC	5.92	1776	948	1184	677	888	710	592	444	395	355	284	237	203
	4.0	XC	6.84	2052	1094	1368	782	1026	821	684	513	456	410	328	274	235
	5.0	VC	7.64	2292	1224	1528	874	1146	917	764	573	509	458	367	306	262
	6.0	VC	8.37	2511	1342	1674	958	1256	1004	837	628	558	502	402	335	287
7.0	C	9.04	2712	1447	1808	1034	1356	1085	904	678	603	542	434	362	310	

**Note:** Always double check your application rates. Droplet size classification shown is based on ISO 25358. Droplet size classification standard is subject to change. Tabulations are based on spraying water at 21°C. See technical information (pages 179–202) for droplet size classification, useful formulas and other technical information.

## LERAP RATINGS

TIP & CAPACITY	PRESSURE (bar)	STAR RATING	TIP & CAPACITY	PRESSURE (bar)	STAR RATING
TTI11002	1.0–5.0	★★★	TTI11004	1.0–7.0	★★★
	6.0–7.0	★★	TTI11005	1.0–7.0	★★★
TTI110025	1.0–5.0	★★★	TTI11006	1.0–5.0	★★★
	6.0–7.0	★★		6.0–7.0	★★
TTI11003	1.0–5.0	★★★			
	6.0–7.0	★★			



Visit [www.teejet.com](http://www.teejet.com) for updated charts.





BROADCAST NOZZLES

## Typical Applications



**HERBICIDE**  
SOIL APPLIED  
**EXCELLENT**  
SYSTEMIC  
**EXCELLENT**



**FERTILIZER**  
BROADCAST  
**EXCELLENT**



**DRIFT CONTROL**  
**EXCELLENT**



**PWM APPROVED**



### FEATURES

- TTI60 produces two 110° wide angle, flat spray patterns for uniform coverage in broadcast applications.
- Extremely large drift resistant droplets are produced through the use of a venturi air aspirator.
- Provides excellent drift control and produces minimal driftable fines—less than 1.5%.\*
- 60° angle between leading and trailing patterns for increased canopy penetration and leaf coverage.
- All in one molded nozzle and Quick TeeJet® cap design provides automatic spray alignment.
- Removable pre-orifice allows for disassembly and cleaning.
- Available in seven VisiFlo® Polymer (VP) capacities.
- Replacement gasket: CP19438-1-EPR

\* -04 capacity spraying water at 2.8 bar. Driftable fines defined as droplets smaller than 150 microns.

### SPRAY PATTERN



### DROPLET SIZE CLASSIFICATION

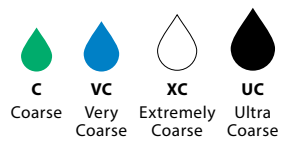

### OPTIMUM SPRAY HEIGHT

	50 cm SPACING 
<b>ANGLE</b>	<b>HEIGHT</b>
110°	50 cm

### RECOMMENDED PRESSURE RANGE



### MATERIALS AVAILABLE



### HOW TO ORDER

Polymer with VisiFlo color-coding  
**TTI60-11004VP**

Tip Type	Spray Angle	Capacity Size	Material Code



BROADCAST NOZZLES

TIP PART NO. (STRAINER MESH SIZE)	bar	DROP SIZE	CAPACITY ONE TIP IN l/min	APPLICATION RATE FOR 50 cm SPRAY TIP SPACING												
				l/ha												
				4 km/h	5 km/h	6 km/h	7 km/h	8 km/h	10 km/h	12 km/h	16 km/h	18 km/h	20 km/h	25 km/h	30 km/h	35 km/h
TTI60-11002VP (50)	1.5	XC	0.56	168	134	112	96	84.0	67.2	56.0	42.0	37.3	33.6	26.9	22.4	19.2
	2.0	XC	0.65	195	156	130	111	97.5	78.0	65.0	48.8	43.3	39.0	31.2	26.0	22.3
	3.0	VC	0.79	237	190	158	135	119	94.8	79.0	59.3	52.7	47.4	37.9	31.6	27.1
	4.0	VC	0.91	273	218	182	156	137	109	91.0	68.3	60.7	54.6	43.7	36.4	31.2
	5.0	C	1.02	306	245	204	175	153	122	102	76.5	68.0	61.2	49.0	40.8	35.0
	6.0	C	1.12	336	269	224	192	168	134	112	84.0	74.7	67.2	53.8	44.8	38.4
	7.0	C	1.21	363	290	242	207	182	145	121	90.8	80.7	72.6	58.1	48.4	41.5
TTI60-110025VP (50)	1.5	XC	0.70	210	168	140	120	105	84.0	70.0	52.5	46.7	42.0	33.6	28.0	24.0
	2.0	XC	0.81	243	194	162	139	122	97.2	81.0	60.8	54.0	48.6	38.9	32.4	27.8
	3.0	VC	0.99	297	238	198	170	149	119	99.0	74.3	66.0	59.4	47.5	39.6	33.9
	4.0	VC	1.14	342	274	228	195	171	137	114	85.5	76.0	68.4	54.7	45.6	39.1
	5.0	C	1.28	384	307	256	219	192	154	128	96.0	85.3	76.8	61.4	51.2	43.9
	6.0	C	1.40	420	336	280	240	210	168	140	105	93.3	84.0	67.2	56.0	48.0
	7.0	C	1.51	453	362	302	259	227	181	151	113	101	90.6	72.5	60.4	51.8
TTI60-11003VP (50)	1.5	UC	0.83	249	199	166	142	125	99.6	83.0	62.3	55.3	49.8	39.8	33.2	28.5
	2.0	UC	0.96	288	230	192	165	144	115	96.0	72.0	64.0	57.6	46.1	38.4	32.9
	3.0	XC	1.18	354	283	236	202	177	142	118	88.5	78.7	70.8	56.6	47.2	40.5
	4.0	VC	1.36	408	326	272	233	204	163	136	102	90.7	81.6	65.3	54.4	46.6
	5.0	VC	1.52	456	365	304	261	228	182	152	114	101	91.2	73.0	60.8	52.1
	6.0	VC	1.67	501	401	334	286	251	200	167	125	111	100	80.2	66.8	57.3
	7.0	C	1.80	540	432	360	309	270	216	180	135	120	108	86.4	72.0	61.7
TTI60-11004VP (50)	1.5	UC	1.12	336	269	224	192	168	134	112	84.0	74.7	67.2	53.8	44.8	38.4
	2.0	UC	1.29	387	310	258	221	194	155	129	96.8	86.0	77.4	61.9	51.6	44.2
	3.0	XC	1.58	474	379	316	271	237	190	158	119	105	94.8	75.8	63.2	54.2
	4.0	VC	1.82	546	437	364	312	273	218	182	137	121	109	87.4	72.8	62.4
	5.0	VC	2.04	612	490	408	350	306	245	204	153	136	122	97.9	81.6	69.9
	6.0	VC	2.23	669	535	446	382	335	268	223	167	149	134	107	89.2	76.5
	7.0	C	2.41	723	578	482	413	362	289	241	181	161	145	116	96.4	82.6
TTI60-11005VP (50)	1.5	UC	1.39	417	334	278	238	209	167	139	104	92.7	83.4	66.7	55.6	47.7
	2.0	UC	1.61	483	386	322	276	242	193	161	121	107	96.6	77.3	64.4	55.2
	3.0	XC	1.97	591	473	394	338	296	236	197	148	131	118	94.6	78.8	67.5
	4.0	VC	2.27	681	545	454	389	341	272	227	170	151	136	109	90.8	77.8
	5.0	VC	2.54	762	610	508	435	381	305	254	191	169	152	122	102	87.1
	6.0	VC	2.79	837	670	558	478	419	335	279	209	186	167	134	112	95.7
	7.0	C	3.01	903	722	602	516	452	361	301	226	201	181	144	120	103
TTI60-11006VP (50)	1.5	UC	1.68	504	403	336	288	252	202	168	126	112	101	80.6	67.2	57.6
	2.0	UC	1.94	582	466	388	333	291	233	194	146	129	116	93.1	77.6	66.5
	3.0	XC	2.37	711	569	474	406	356	284	237	178	158	142	114	94.8	81.3
	4.0	VC	2.74	822	658	548	470	411	329	274	206	183	164	132	110	93.9
	5.0	VC	3.06	918	734	612	525	459	367	306	230	204	184	147	122	105
	6.0	VC	3.35	1005	804	670	574	503	402	335	251	223	201	161	134	115
	7.0	C	3.62	1086	869	724	621	543	434	362	272	241	217	174	145	124
TTI60-11008VP (50)	1.5	UC	2.23	669	535	446	382	335	268	223	167	149	134	107	89.2	76.5
	2.0	UC	2.58	774	619	516	442	387	310	258	194	172	155	124	103	88.5
	3.0	XC	3.16	948	758	632	542	474	379	316	237	211	190	152	126	108
	4.0	XC	3.65	1095	876	730	626	548	438	365	274	243	219	175	146	125
	5.0	VC	4.08	1224	797	816	699	612	490	408	306	272	245	196	163	140
	6.0	VC	4.47	1341	1073	894	766	671	536	447	335	298	268	215	179	153
	7.0	C	4.83	1449	1159	966	828	725	580	483	362	322	290	232	193	166

**Note:** Always double check your application rates. Droplet size classification shown is based on ISO 25358. Droplet size classification standard is subject to change. Tabulations are based on spraying water at 21°C. See technical information (pages 179–202) for droplet size classification, useful formulas and other technical information.

TIP & CAPACITY	PRESSURE (bar)	STAR RATING
TTI60-11002	1.5–4.25	★★★
	4.26–5.0	★★
TTI60-110025	1.5–5.0	★★★
TTI60-11003	1.5–5.0	★★★
TTI60-11004	1.5–5.0	★★★
TTI60-11005	1.5–5.0	★★★



Visit [www.teejet.com](http://www.teejet.com) for updated charts.



BROADCAST NOZZLES

### Typical Applications



**HERBICIDE**  
CONTACT  
**VERY GOOD**  
SYSTEMIC  
**GOOD**



**FUNGICIDE**  
CONTACT  
**EXCELLENT**  
SYSTEMIC  
**GOOD**



**INSECTICIDE**  
CONTACT  
**EXCELLENT**  
SYSTEMIC  
**GOOD**



**DRIFT CONTROL**  
**GOOD**



**PWM APPROVED**



### FEATURES

- Tapered edge flat spray angle pattern for uniform coverage in broadcast spray application.
- Reduces drift at lower pressures, better coverage at higher pressures.
- Ceramic is available with corrosive resistant polypropylene VisiFlo color-coded tip holder in 80° capacities 03-08 and 110° capacities 02-08.
- XR110025 only available in VK.
- XR80025 and XR80035 only available in VS.
- Brass available in 110° only.
- Automatic spray alignment with 114441A-\*-CELR (01 to 08) or 114443A-\*-CELR (10 and 15) Quick TeeJet® cap and gasket. Reference page 118 for more information.

### SPRAY PATTERN

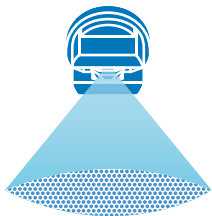

### DROPLET SIZE CLASSIFICATION

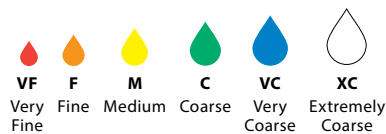

### OPTIMUM SPRAY HEIGHT

ANGLE	HEIGHT
80°	75 cm
110°	50 cm

### RECOMMENDED PRESSURE RANGE



### MATERIALS AVAILABLE

- VS** STAINLESS STEEL
- VP** POLYMER
- VK** CERAMIC
- VB** BRASS
- SS** STAINLESS STEEL

### HOW TO ORDER

Ceramic with VisiFlo® color-coding

**X R 1 1 0 0 4 - V K**

Tip Type   Spray Angle   Capacity Size   Material Code

Polymer with VisiFlo color-coding, includes Quick TeeJet cap and gasket\*

**X R 1 1 0 0 2 - V P - C E**

Tip Type   Spray Angle   Capacity Size   Material Code   Cap and Gasket Included

\*Reference page 118 for more caps information.





TIP PART NO. (STRAINER MESH SIZE)	bar	DROPSIZE		CAPACITY ONE TIP IN l/min	APPLICATION RATE FOR 50 cm SPRAY TIP SPACING												
		80°	110°		l/ha												
		4 km/h	5 km/h		6 km/h	7 km/h	8 km/h	10 km/h	12 km/h	16 km/h	18 km/h	20 km/h	25 km/h	30 km/h	35 km/h		
XR8001 XR11001 (100)	1.0	F	F	0.23	69.0	55.2	46.0	39.4	34.5	27.6	23.0	17.3	15.3	13.8	11.0	9.2	7.9
	1.5	F	F	0.28	84.0	67.2	56.0	48.0	42.0	33.6	28.0	21.0	18.7	16.8	13.4	11.2	9.6
	2.0	F	F	0.32	96.0	76.8	64.0	54.9	48.0	38.4	32.0	24.0	21.3	19.2	15.4	12.8	11.0
	2.5	F	F	0.36	108	86.4	72.0	61.7	54.0	43.2	36.0	27.0	24.0	21.6	17.3	14.4	12.3
	3.0	F	F	0.39	117	93.6	78.0	66.9	58.5	46.8	39.0	29.3	26.0	23.4	18.7	15.6	13.4
	4.0	F	VF	0.45	135	108	90.0	77.1	67.5	54.0	45.0	33.8	30.0	27.0	21.6	18.0	15.4
XR80015 XR110015 (100)	1.0	M	M	0.34	102	81.6	68.0	58.3	51.0	40.8	34.0	25.5	22.7	20.4	16.3	13.6	11.7
	1.5	F	F	0.42	126	101	84.0	72.0	63.0	50.4	42.0	31.5	28.0	25.2	20.2	16.8	14.4
	2.0	F	F	0.48	144	115	96.0	82.3	72.0	57.6	48.0	36.0	32.0	28.8	23.0	19.2	16.5
	2.5	F	F	0.54	162	130	108	92.6	81.0	64.8	54.0	40.5	36.0	32.4	25.9	21.6	18.5
	3.0	F	F	0.59	177	142	118	101	88.5	70.8	59.0	44.3	39.3	35.4	28.3	23.6	20.2
	4.0	F	F	0.68	204	163	136	117	102	81.6	68.0	51.0	45.3	40.8	32.6	27.2	23.3
XR8002 XR11002 (50)	1.0	M	M	0.46	138	110	92.0	78.9	69.0	55.2	46.0	34.5	30.7	27.6	22.1	18.4	15.8
	1.5	M	M	0.56	168	134	112	96.0	84.0	67.2	56.0	42.0	37.3	33.6	26.9	22.4	19.2
	2.0	F	F	0.65	195	156	130	111	97.5	78.0	65.0	48.8	43.3	39.0	31.2	26.0	22.3
	2.5	F	F	0.72	216	173	144	123	108	86.4	72.0	54.0	48.0	43.2	34.6	28.8	24.7
	3.0	F	F	0.79	237	190	158	135	119	94.8	79.0	59.3	52.7	47.4	37.9	31.6	27.1
	4.0	F	F	0.91	273	218	182	156	137	109	91.0	68.3	60.7	54.6	43.7	36.4	31.2
XR80025 XR110025 (50)	1.0	M	M	0.57	171	137	114	97.7	85.5	68.4	57.0	42.8	38.0	34.2	27.4	22.8	19.5
	1.5	M	M	0.70	210	168	140	120	105	84.0	70.0	52.5	46.7	42.0	33.6	28.0	24.0
	2.0	M	M	0.81	243	194	162	139	122	97.2	81.0	60.8	54.0	48.6	38.9	32.4	27.8
	2.5	F	F	0.90	270	216	180	154	135	108	90.0	67.5	60.0	54.0	43.2	36.0	30.9
	3.0	F	F	0.99	297	238	198	170	149	119	99.0	74.3	66.0	59.4	47.5	39.6	33.9
	4.0	F	F	1.14	342	274	228	195	171	137	114	85.5	76.0	68.4	54.7	45.6	39.1
XR8003 XR11003 (50)	1.0	M	M	0.68	204	163	136	117	102	81.6	68.0	51.0	45.3	40.8	32.6	27.2	23.3
	1.5	M	M	0.83	249	199	166	142	125	99.6	83.0	62.3	55.3	49.8	39.8	33.2	28.5
	2.0	M	M	0.96	288	230	192	165	144	115	96.0	72.0	64.0	57.6	46.1	38.4	32.9
	2.5	M	M	1.08	324	259	216	185	162	130	108	81.0	72.0	64.8	51.8	43.2	37.0
	3.0	F	F	1.18	354	283	236	202	177	142	118	88.5	78.7	70.8	56.6	47.2	40.5
	4.0	F	F	1.36	408	326	272	233	204	163	136	102	90.7	81.6	65.3	54.4	46.6
XR80035 (50)	1.0	M		0.80	240	192	160	137	120	96.0	80.0	60.0	53.3	48.0	38.4	32.0	27.4
	1.5	M		0.98	294	235	196	168	147	118	98.0	73.5	65.3	58.8	47.0	39.2	33.6
	2.0	M		1.13	339	271	226	194	170	136	113	84.8	75.3	67.8	54.2	45.2	38.7
	2.5	M		1.26	378	302	252	216	189	151	126	94.5	84.0	75.6	60.5	50.4	43.2
	3.0	M		1.38	414	331	276	237	207	166	138	104	92.0	82.8	66.2	55.2	47.3
	4.0	F		1.59	477	382	318	273	239	191	159	119	106	95.4	76.3	63.6	54.5
XR8004 XR11004 (50)	1.0	M	M	0.91	273	218	182	156	137	109	91.0	68.3	60.7	54.6	43.7	36.4	31.2
	1.5	M	M	1.12	336	269	224	192	168	134	112	84.0	74.7	67.2	53.8	44.8	38.4
	2.0	M	M	1.29	387	310	258	221	194	155	129	96.8	86.0	77.4	61.9	51.6	44.2
	2.5	M	M	1.44	432	346	288	247	216	173	144	108	96.0	86.4	69.1	57.6	49.4
	3.0	M	M	1.58	474	379	316	271	237	190	158	119	105	94.8	75.8	63.2	54.2
	4.0	F	F	1.82	546	437	364	312	273	218	182	137	121	109	87.4	72.8	62.4
XR8005 XR11005 (50)	1.0	C	M	1.14	342	274	228	195	171	137	114	85.5	76.0	68.4	54.7	45.6	39.1
	1.5	M	M	1.39	417	334	278	238	209	167	139	104	92.7	83.4	66.7	55.6	47.7
	2.0	M	M	1.61	483	386	322	276	242	193	161	121	107	96.6	77.3	64.4	55.2
	2.5	M	M	1.80	540	432	360	309	270	216	180	135	120	108	86.4	72.0	61.7
	3.0	M	M	1.97	591	473	394	338	296	236	197	148	131	118	94.6	78.8	67.5
	4.0	F	F	2.27	681	545	454	389	341	272	227	170	151	136	109	90.8	77.8
XR8006 XR11006 (50)	1.0	C	C	1.37	411	329	274	235	206	164	137	103	91.3	82.2	65.8	54.8	47.0
	1.5	C	M	1.68	504	403	336	288	252	202	168	126	112	101	80.6	67.2	57.6
	2.0	M	M	1.94	582	466	388	333	291	233	194	146	129	116	93.1	77.6	66.5
	2.5	M	M	2.16	648	518	432	370	324	259	216	162	144	130	104	86.4	74.1
	3.0	M	M	2.37	711	569	474	406	356	284	237	178	158	142	114	94.8	81.3
	4.0	M	M	2.74	822	658	548	470	411	329	274	206	183	164	132	110	93.9
XR8008 XR11008 (50)	1.0	VC	C	1.82	546	437	364	312	273	218	182	137	121	109	87.4	72.8	62.4
	1.5	C	M	2.23	669	535	446	382	335	268	223	167	149	134	107	89.2	76.5
	2.0	C	M	2.58	774	619	516	442	387	310	258	194	172	155	124	103	88.5
	2.5	M	M	2.88	864	691	576	494	432	346	288	216	192	173	138	115	98.7
	3.0	M	M	3.16	948	758	632	542	474	379	316	237	211	190	152	126	108
	4.0	M	M	3.65	1095	876	730	626	548	438	365	274	243	219	175	146	125
XR8010† XR11010†	1.0	VC	C	2.28	684	547	456	391	342	274	228	171	152	137	109	91.2	78.2
	1.5	C	C	2.79	837	670	558	478	419	335	279	209	186	167	134	112	95.7
	2.0	C	C	3.23	969	775	646	554	485	388	323	242	215	194	155	129	111
	2.5	C	M	3.61	1083	866	722	619	542	433	361	271	241	217	173	144	124
	3.0	M	M	3.95	1185	948	790	677	593	474	395	296	263	237	190	158	135
	4.0	M	M	4.56	1368	1094	912	782	684	547	456	342	304	274	219	182	156
XR8015† XR11015†	1.0	XC	VC	3.42	1026	821	684	586	513	410	342	257	228	205	164	137	117
	1.5	VC	VC	4.19	1257	1006	838	718	629	503	419	314	279	251	201	168	144
	2.0	VC	C	4.83	1449	1159	966	828	725	580	483	362	322	290	232	193	166
	2.5	C	C	5.40	1620	1296	1080	926	810	648	540	405	360	324	259	216	185
	3.0	C	C	5.92	1776	1421	1184	1015	888	710	592	444	395	355	284	237	203
	4.0	M	M	6.84	2052	1642	1368	1173	1026	821	684</						



## Typical Applications



**HERBICIDE**  
CONTACT  
**VERY GOOD**  
SYSTEMIC  
**GOOD**



**FUNGICIDE**  
CONTACT  
**EXCELLENT**  
SYSTEMIC  
**GOOD**



**INSECTICIDE**  
CONTACT  
**EXCELLENT**  
SYSTEMIC  
**GOOD**



**DRIFT CONTROL**  
**GOOD**



**PWM APPROVED**



## FEATURES

- Tapered edge flat spray pattern for uniform coverage in broadcast spraying.
- Reduces drift at lower pressures, improves coverage at higher pressures.
- Various XR orifice materials are permanently assembled into reinforced nylon Quick TeeJet caps, providing reliable XR performance, convenient installation, and automatic pattern alignment.
- Includes tightly fitting gasket that stays put and assures a good seal. Replacement gasket part number: CP19438-1-EPR

## SPRAY PATTERN

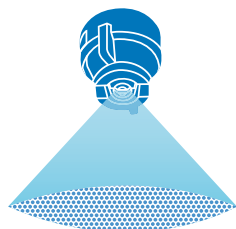

## DROPLET SIZE CLASSIFICATION

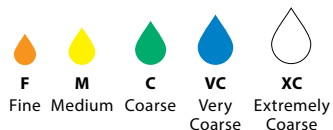

## OPTIMUM SPRAY HEIGHT

ANGLE	HEIGHT
80°	75 cm
110°	50 cm

## RECOMMENDED PRESSURE RANGE



## MATERIALS AVAILABLE

- VS** STAINLESS STEEL
- VP** POLYMER
- VK** CERAMIC

## HOW TO ORDER

Stainless Steel with VisiFlo® color-coding

**X R C 1 1 0 0 4 - V S**

Tip Type    Spray Angle    Capacity Size    Material Code

Polymer with VisiFlo color-coding

**X R C 1 1 0 0 4 - V P**

Tip Type    Spray Angle    Capacity Size    Material Code

Ceramic with VisiFlo color-coding

**X R C 1 1 0 0 4 - V K**

Tip Type    Spray Angle    Capacity Size    Material Code



BROADCAST NOZZLES

TIP PART NO. (STRAINER MESH SIZE)	bar	DROP SIZE		CAPACITY ONE TIP IN l/min	APPLICATION RATE FOR 50 cm SPRAY TIP SPACING												
		80°	110°		l/ha												
		4 km/h	5 km/h		6 km/h	7 km/h	8 km/h	10 km/h	12 km/h	16 km/h	18 km/h	20 km/h	25 km/h	30 km/h	35 km/h		
XRC80015 XRC110015 (100)	1.0	M	M	0.34	102	81.6	68.0	58.3	51.0	40.8	34.0	25.5	22.7	20.4	16.3	13.6	11.7
	1.5	F	F	0.42	126	101	84.0	72.0	63.0	50.4	42.0	31.5	28.0	25.2	20.2	16.8	14.4
	2.0	F	F	0.48	144	115	96.0	82.3	72.0	57.6	48.0	36.0	32.0	28.8	23.0	19.2	16.5
	3.0	F	F	0.59	177	142	118	101	88.5	70.8	59.0	44.3	39.3	35.4	28.3	23.6	20.2
	4.0	F	F	0.68	204	163	136	117	102	81.6	68.0	51.0	45.3	40.8	32.6	27.2	23.3
XRC8002 XRC11002 (50)	1.0	M	M	0.46	138	110	92.0	78.9	69.0	55.2	46.0	34.5	30.7	27.6	22.1	18.4	15.8
	1.5	M	M	0.56	168	134	112	96.0	84.0	67.2	56.0	42.0	37.3	33.6	26.9	22.4	19.2
	2.0	F	F	0.65	195	156	130	111	97.5	78.0	65.0	48.8	43.3	39.0	31.2	26.0	22.3
	3.0	F	F	0.79	237	190	158	135	119	94.8	79.0	59.3	52.7	47.4	37.9	31.6	27.1
	4.0	F	F	0.91	273	218	182	156	137	109	91.0	68.3	60.7	54.6	43.7	36.4	31.2
XRC80025 XRC110025 (50)	1.0	M	M	0.57	171	137	114	97.7	85.5	68.4	57.0	42.8	38.0	34.2	27.4	22.8	19.5
	1.5	M	M	0.70	210	168	140	120	105	84.0	70.0	52.5	46.7	42.0	33.6	28.0	24.0
	2.0	M	M	0.81	243	194	162	139	122	97.2	81.0	60.8	54.0	48.6	38.9	32.4	27.8
	3.0	F	F	0.99	297	238	198	170	149	119	99.0	74.3	66.0	59.4	47.5	39.6	33.9
	4.0	F	F	1.14	342	274	228	195	171	137	114	85.5	76.0	68.4	54.7	45.6	39.1
XRC8003 XRC11003 (50)	1.0	M	M	0.68	204	163	136	117	102	81.6	68.0	51.0	45.3	40.8	32.6	27.2	23.3
	1.5	M	M	0.83	249	199	166	142	125	99.6	83.0	62.3	55.3	49.8	39.8	33.2	28.5
	2.0	M	M	0.96	288	230	192	165	144	115	96.0	72.0	64.0	57.6	46.1	38.4	32.9
	3.0	F	F	1.18	354	283	236	202	177	142	118	88.5	78.7	70.8	56.6	47.2	40.5
	4.0	F	F	1.36	408	326	272	233	204	163	136	102	90.7	81.6	65.3	54.4	46.6
XRC8004 XRC11004 (50)	1.0	M	M	0.91	273	218	182	156	137	109	91.0	68.3	60.7	54.6	43.7	36.4	31.2
	1.5	M	M	1.12	336	269	224	192	168	134	112	84.0	74.7	67.2	53.8	44.8	38.4
	2.0	M	M	1.29	387	310	258	221	194	155	129	96.8	86.0	77.4	61.9	51.6	44.2
	3.0	M	M	1.58	474	379	316	271	237	190	158	119	105	94.8	75.8	63.2	54.2
	4.0	F	F	1.82	546	437	364	312	273	218	182	137	121	109	87.4	72.8	62.4
XRC8005 XRC11005 (50)	1.0	C	M	1.14	342	274	228	195	171	137	114	85.5	76.0	68.4	54.7	45.6	39.1
	1.5	M	M	1.39	417	334	278	238	209	167	139	104	92.7	83.4	66.7	55.6	47.7
	2.0	M	M	1.61	483	386	322	276	242	193	161	121	107	96.6	77.3	64.4	55.2
	3.0	M	M	1.97	591	473	394	338	296	236	197	148	131	118	94.6	78.8	67.5
	4.0	F	F	2.27	681	545	454	389	341	272	227	170	151	136	109	90.8	77.8
XRC8006 XRC11006 (50)	1.0	C	C	1.37	411	329	274	235	206	164	137	103	91.3	82.2	65.8	54.8	47.0
	1.5	C	M	1.68	504	403	336	288	252	202	168	126	112	101	80.6	67.2	57.6
	2.0	M	M	1.94	582	466	388	333	291	233	194	146	129	116	93.1	77.6	66.5
	3.0	M	M	2.37	711	569	474	406	356	284	237	178	158	142	114	94.8	81.3
	4.0	M	M	2.74	822	658	548	470	411	329	274	206	183	164	132	110	93.9
XRC8008 XRC11008 (50)	1.0	VC	C	1.82	546	437	364	312	273	218	182	137	121	109	87.4	72.8	62.4
	1.5	C	M	2.23	669	535	446	382	335	268	223	167	149	134	107	89.2	76.5
	2.0	C	M	2.58	774	619	516	442	387	310	258	194	172	155	124	103	88.5
	3.0	M	M	3.16	948	758	632	542	474	379	316	237	211	190	152	126	108
	4.0	M	M	3.65	1095	876	730	626	548	438	365	274	243	219	175	146	125
XRC8010 XRC11010	1.0	VC	C	2.28	684	547	456	391	342	274	228	171	152	137	109	91.2	78.2
	1.5	C	C	2.79	837	670	558	478	419	335	279	209	186	167	134	112	95.7
	2.0	C	C	3.23	969	775	646	554	485	388	323	242	215	194	155	129	111
	3.0	M	M	3.95	1185	948	790	677	593	474	395	296	263	237	190	158	135
	4.0	M	M	4.56	1368	1094	912	782	684	547	456	342	304	274	219	182	156
XR8015† XR11015†	1.0	VC	VC	3.42	1026	821	684	586	513	410	342	257	228	205	164	137	117
	1.5	VC	VC	4.19	1257	1006	838	718	629	503	419	314	279	251	201	168	144
	2.0	C	C	4.83	1449	1159	966	828	725	580	483	362	322	290	232	193	166
	3.0	C	C	5.92	1776	1421	1184	1015	888	710	592	444	395	355	284	237	203
	4.0	M	M	6.84	2052	1642	1368	1173	1026	821	684	513	456	410	328	274	235
XRC11020	1.0		XC	4.56	1368	1094	912	782	684	547	456	342	304	274	219	182	156
	1.5		VC	5.58	1674	1339	1116	957	837	670	558	419	372	335	268	223	191
	2.0		VC	6.44	1932	1546	1288	1104	966	773	644	483	429	386	309	258	221
	3.0		C	7.89	2367	1894	1578	1353	1184	947	789	592	526	473	379	316	271
	4.0		C	9.11	2733	2186	1822	1562	1367	1093	911	683	607	547	437	364	312

**Note:** Always double check your application rates. Droplet size classification shown is based on ISO 25358. Droplet size classification standard is subject to change. Tabulations are based on spraying water at 21°C. See technical information (pages 179–202) for droplet size classification, useful formulas and other technical information.

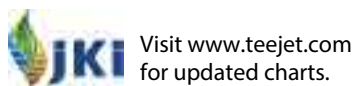





## Typical Applications

<b>HERBICIDE</b>	<b>FUNGICIDE</b>	<b>INSECTICIDE</b>	<b>FERTILIZER</b>	<b>DRIFT CONTROL</b>	<b>PWM APPROVED</b>	
SOIL APPLIED	CONTACT	CONTACT	BROADCAST			
<b>EXCELLENT</b>	<b>EXCELLENT</b>	<b>EXCELLENT</b>	<b>EXCELLENT</b>	<b>GOOD</b>		
CONTACT	SYSTEMIC	SYSTEMIC				
<b>VERY GOOD</b>	<b>GOOD</b>	<b>GOOD</b>				
SYSTEMIC						
<b>GOOD</b>						

## FEATURES

- Tapered edge flat spray pattern for uniform coverage in broadcast spraying.
- VisiFlo® color-coded version available in stainless steel, ceramic and polymer in 80° or 110° spray angles in selected sizes.
- Available in ceramic 80° capacities 01–02 and 110° capacities 01–015. See XR and XRC TeeJet® tips on pages 28–31 for larger capacities.
- See pages 68–69 for TeeJet even flat spray tips.
- Automatic spray alignment with 114441A-\*–CELR (0065 to 08) or 114443A-\*–CELR (10 to 20) Quick TeeJet® cap and gasket. Reference page 118 for more information.

## SPRAY PATTERN

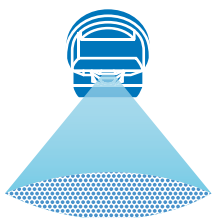

## DROPLET SIZE CLASSIFICATION

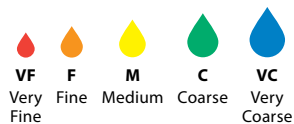

## OPTIMUM SPRAY HEIGHT

ANGLE	50 cm SPACING HEIGHT
65°	90 cm
80°	75 cm
110°	50 cm

## MATERIALS AVAILABLE

- VS** STAINLESS STEEL
- VP** POLYMER
- HSS** HARDENED STAINLESS STEEL
- B** BRASS

## RECOMMENDED PRESSURE RANGE



## HOW TO ORDER

Stainless Steel with VisiFlo color-coding

T P 8 0 0 2 V S  
 Tip Type Spray Angle Capacity Size Material Code

Polymer with VisiFlo color-coding

T P 1 1 0 0 2 V P  
 Tip Type Spray Angle Capacity Size Material Code

Brass

T P 1 1 0 0 3  
 Tip Type Spray Angle Capacity Size



BROADCAST NOZZLES

TIP PART NO. (STRAINER MESH SIZE)	bar	DROP SIZE		CAPACITY ONE TIP IN /min	APPLICATION RATE FOR 50 cm SPRAY TIP SPACING													
		80°	110°		l/ha													
					4 km/h	5 km/h	6 km/h	7 km/h	8 km/h	10 km/h	12 km/h	16 km/h	18 km/h	20 km/h	25 km/h	30 km/h	35 km/h	
TP650050† TP800050† TP1100050† (100)	2.0	F	VF	0.16	48.0	38.4	32.0	27.4	24.0	19.2	16.0	12.0	10.7	9.6	7.7	6.4	5.5	
	2.5	F	VF	0.18	54.0	43.2	36.0	30.9	27.0	21.6	18.0	13.5	12.0	10.8	8.6	7.2	6.2	
	3.0	VF	VF	0.20	60.0	48.0	40.0	34.3	30.0	24.0	20.0	15.0	13.3	12.0	9.6	8.0	6.9	
	3.5	VF	VF	0.22	66.0	52.8	44.0	37.7	33.0	26.4	22.0	16.5	14.7	13.2	10.6	8.8	7.5	
4.0	VF	VF	0.23	69.0	55.2	46.0	39.4	34.5	27.6	23.0	17.3	15.3	13.8	11.0	9.2	7.9		
TP650067† TP800067† TP1100067† (100)	2.0	F	F	0.21	63.0	50.4	42.0	36.0	31.5	25.2	21.0	15.8	14.0	12.6	10.1	8.4	7.2	
	2.5	VF	F	0.24	72.0	57.6	48.0	41.1	36.0	28.8	24.0	18.0	16.0	14.4	11.5	9.6	8.2	
	3.0	VF	F	0.26	78.0	62.4	52.0	44.6	39.0	31.2	26.0	19.5	17.3	15.6	12.5	10.4	8.9	
	3.5	VF	VF	0.28	84.0	67.2	56.0	48.0	42.0	33.6	28.0	21.0	18.7	16.8	13.4	11.2	9.6	
4.0	VF	VF	0.30	90.0	72.0	60.0	51.4	45.0	36.0	30.0	22.5	20.0	18.0	14.4	12.0	10.3		
TP6501†	2.0	F	F	0.32	96.0	76.8	64.0	54.9	48.0	38.4	32.0	24.0	21.3	19.2	15.4	12.8	11.0	
	2.5	F	F	0.36	108	86.4	72.0	61.7	54.0	43.2	36.0	27.0	24.0	21.6	17.3	14.4	12.3	
TP8001 TP11001 (100)	3.0	F	F	0.39	117	93.6	78.0	66.9	58.5	46.8	39.0	29.3	26.0	23.4	18.7	15.6	13.4	
	3.5	VF	F	0.42	126	101	84.0	72.0	63.0	50.4	42.0	31.5	28.0	25.2	20.2	16.8	14.4	
	4.0	VF	VF	0.45	135	108	90.0	77.1	67.5	54.0	45.0	33.8	30.0	27.0	21.6	18.0	15.4	
TP65015†	2.0	F	F	0.48	144	115	96.0	82.3	72.0	57.6	48.0	36.0	32.0	28.8	23.0	19.2	16.5	
	2.5	F	F	0.54	162	130	108	92.6	81.0	64.8	54.0	40.5	36.0	32.4	25.9	21.6	18.5	
	3.0	F	F	0.59	177	142	118	101	88.5	70.8	59.0	44.3	39.3	35.4	28.3	23.6	20.2	
	3.5	F	F	0.64	192	154	128	110	96.0	76.8	64.0	48.0	42.7	38.4	30.7	25.6	21.9	
4.0	F	F	0.68	204	163	136	117	102.0	81.6	68.0	51.0	45.3	40.8	32.6	27.2	23.3		
TP6502†	2.0	F	M	0.65	195	156	130	111	97.5	78.0	65.0	48.8	43.3	39.0	31.2	26.0	22.3	
	2.5	F	F	0.72	216	173	144	123	108	86.4	72.0	54.0	48.0	43.2	34.6	28.8	24.7	
	3.0	F	F	0.79	237	190	158	135	119	94.8	79.0	59.3	52.7	47.4	37.9	31.6	27.1	
	3.5	F	F	0.85	255	204	170	146	128	102	85.0	63.8	56.7	51.0	40.8	34.0	29.1	
4.0	F	F	0.91	273	218	182	156	137	109	91.0	68.3	60.7	54.6	43.7	36.4	31.2		
TP6503†	2.0	M	M	0.96	288	230	192	165	144	115	96.0	72.0	64.0	57.6	46.1	38.4	32.9	
	2.5	F	M	1.08	324	259	216	185	162	130	108	81.0	72.0	64.8	51.8	43.2	37.0	
	3.0	F	M	1.18	354	283	236	202	177	142	118	88.5	78.7	70.8	56.6	47.2	40.5	
	3.5	F	F	1.27	381	305	254	218	191	152	127	95.3	84.7	76.2	61.0	50.8	43.5	
4.0	F	F	1.36	408	326	272	233	204	163	136	102.0	90.7	81.6	65.3	54.4	46.6		
TP6504†	2.0	M	M	1.29	387	310	258	221	194	155	129	96.8	86.0	77.4	61.9	51.6	44.2	
	2.5	F	M	1.44	432	346	288	247	216	173	144	108	96.0	86.4	69.1	57.6	49.4	
	3.0	F	M	1.58	474	379	316	271	237	190	158	119	105	94.8	75.8	63.2	54.2	
	3.5	F	M	1.71	513	410	342	293	257	205	171	128	114	103	82.1	68.4	58.6	
4.0	F	M	1.82	546	437	364	312	273	218	182	137	121	109	87.4	72.8	62.4		
TP6505†	2.0	M	M	1.61	483	386	322	276	242	193	161	121	107	96.6	77.3	64.4	55.2	
	2.5	M	M	1.80	540	432	360	309	270	216	180	135	120	108	86.4	72.0	61.7	
	3.0	M	M	1.97	591	473	394	338	296	236	197	148	131	118	94.6	78.8	67.5	
	3.5	M	M	2.13	639	511	426	365	320	256	213	160	142	128	102	85.2	73.0	
4.0	M	M	2.27	681	545	454	389	341	272	227	170	151	136	109	90.8	77.8		
TP6506†	2.0	M	C	1.94	582	466	388	333	291	233	194	146	129	116	93.1	77.6	66.5	
	2.5	M	M	2.16	648	518	432	370	324	259	216	162	144	130	104	86.4	74.1	
	3.0	M	M	2.37	711	569	474	406	356	284	237	178	158	142	114	94.8	81.3	
	3.5	M	M	2.56	768	614	512	439	384	307	256	192	171	154	123	102	87.8	
4.0	M	M	2.74	822	658	548	470	411	329	274	206	183	164	132	110	93.9		
TP6508†	2.0	M	C	2.58	774	619	516	442	387	310	258	194	172	155	124	103	88.5	
	2.5	M	C	2.88	864	691	576	494	432	346	288	216	192	173	138	115	98.7	
	3.0	M	M	3.16	948	758	632	542	474	379	316	237	211	190	152	126	108	
	3.5	M	M	3.41	1023	818	682	585	512	409	341	256	227	205	164	136	117	
4.0	M	M	3.65	1095	876	730	626	548	438	365	274	243	219	175	146	125		
TP6510† TP8010† TP11010†	2.0	C	C	3.23	969	775	646	554	485	388	323	242	215	194	155	129	111	
	2.5	M	C	3.61	1083	866	722	619	542	433	361	271	241	217	173	144	124	
	3.0	M	M	3.95	1185	948	790	677	593	474	395	296	263	237	190	158	135	
	3.5	M	M	4.27	1281	1025	854	732	641	512	427	320	285	256	205	171	146	
4.0	M	M	4.56	1368	1094	912	782	684	547	456	342	304	274	219	182	156		
TP6515† TP8015† TP11015†	2.0	C	VC	4.83	1449	1159	966	828	725	580	483	362	322	290	232	193	166	
	2.5	C	C	5.40	1620	1296	1080	926	810	648	540	405	360	324	259	216	185	
	3.0	C	C	5.92	1776	1421	1184	1015	888	710	592	444	395	355	284	237	203	
	3.5	M	C	6.39	1917	1534	1278	1095	959	767	639	479	426	383	307	256	219	
4.0	M	C	6.84	2052	1642	1368	1173	1026	821	684	513	456	410	328	274	235		
TP6520† TP8020† TP11020†	2.0	VC	VC	6.44	1932	1546	1288	1104	966	773	644	483	429	386	309	258	221	
	2.5	C	C	7.20	2160	1728	1440	1234	1080	864	720	540	480	432	346	288	247	
	3.0	C	C	7.89	2367	1894	1578	1353	1184	947	789	592	526	473	379	316	271	
	3.5	C	C	8.52	2556	2045	1704	1461	1278	1022	852	639	568	511	409	341	292	
4.0	C	C	9.11	2733	2186	1822	1562	1367	1093	911	683	607	547	437	364	312		

**Note:** Always double check your application rates. Droplet size classification shown is based on ISO 25358. Droplet size classification standard is subject to change. Tabulations are based on spraying water at 21°C. See technical information (pages 179–202) for droplet size classification, useful formulas and other technical information.

†Available in brass and/or stainless steel and/or hardened stainless steel.



BROADCAST NOZZLES

### Typical Applications



**HERBICIDE**  
SOIL APPLIED  
**VERY GOOD**  
CONTACT  
**EXCELLENT**  
SYSTEMIC  
**EXCELLENT**



**FUNGICIDE**  
SYSTEMIC  
**EXCELLENT**



**INSECTICIDE**  
SYSTEMIC  
**EXCELLENT**



**FERTILIZER**  
BROADCAST  
**EXCELLENT**



**DRIFT CONTROL**  
**GOOD**



**PWM APPROVED**



### FEATURES

- Pre-orifice design produces larger droplets and reduces the small drift-prone droplets, minimizing off-target spray contamination.
- Tapered edge flat spray pattern provides uniform coverage when adjacent nozzle patterns are overlapped in broadcast spraying.
- The color-coded pre-orifice is removable for any necessary cleaning operations.
- Available in five Visiflo® Stainless Steel (VS) and Visiflo Polymer (VP) capacities.
- Automatic spray alignment with 114441A-\* CELR Quick TeeJet® cap and gasket. Reference page 118 for more information.

### SPRAY PATTERN

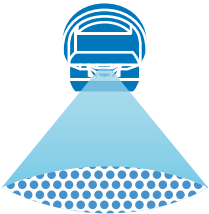

### DROPLET SIZE CLASSIFICATION

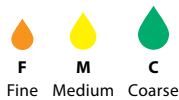

### OPTIMUM SPRAY HEIGHT

50 cm SPACING	
ANGLE	HEIGHT
80°	75 cm
110°	50 cm

### RECOMMENDED PRESSURE RANGE



### MATERIALS AVAILABLE

- VS** STAINLESS STEEL
- VP** POLYMER

### HOW TO ORDER

Stainless Steel with VisiFlo color-coding  
**D G 8 0 0 2 V S**

Tip Type   Spray Angle   Capacity Size   Material Code

Polymer with VisiFlo color-coding  
**D G 1 1 0 0 2 - V P**

Tip Type   Spray Angle   Capacity Size   Material Code



BROADCAST NOZZLES

TIP PART NO. (STRAINER MESH SIZE)	bar	DROP SIZE		CAPACITY ONE TIP IN l/min	APPLICATION RATE FOR 50 cm SPRAY TIP SPACING												
		80°	110°		l/ha												
					4 km/h	5 km/h	6 km/h	7 km/h	8 km/h	10 km/h	12 km/h	16 km/h	18 km/h	20 km/h	25 km/h	30 km/h	35 km/h
DG80015† DG110015 (100)	2.0	M	M	0.48	144	115	96.0	82.3	72.0	57.6	48.0	36.0	32.0	28.8	23.0	19.2	16.5
	2.5	M	M	0.54	162	130	108	92.6	81.0	64.8	54.0	40.5	36.0	32.4	25.9	21.6	18.5
	3.0	F	M	0.59	177	142	118	101	88.5	70.8	59.0	44.3	39.3	35.4	28.3	23.6	20.2
	4.0	F	M	0.68	204	163	136	117	102	81.6	68.0	51.0	45.3	40.8	32.6	27.2	23.3
	5.0	F	F	0.76	228	182	152	130	114	91.2	76.0	57.0	50.7	45.6	36.5	30.4	26.1
DG8002† DG11002 (50)	2.0	C	C	0.65	195	156	130	111	97.5	78.0	65.0	48.8	43.3	39.0	31.2	26.0	22.3
	2.5	M	C	0.72	216	173	144	123	108	86.4	72.0	54.0	48.0	43.2	34.6	28.8	24.7
	3.0	M	M	0.79	237	190	158	135	119	94.8	79.0	59.3	52.7	47.4	37.9	31.6	27.1
	4.0	M	M	0.91	273	218	182	156	137	109	91.0	68.3	60.7	54.6	43.7	36.4	31.2
	5.0	M	M	1.02	306	245	204	175	153	122	102	76.5	68.0	61.2	49.0	40.8	35.0
DG8003† DG11003 (50)	2.0	C	C	0.96	288	230	192	165	144	115	96.0	72.0	64.0	57.6	46.1	38.4	32.9
	2.5	M	C	1.08	324	259	216	185	162	130	108	81.0	72.0	64.8	51.8	43.2	37.0
	3.0	M	M	1.18	354	283	236	202	177	142	118	88.5	78.7	70.8	56.6	47.2	40.5
	4.0	M	M	1.36	408	326	272	233	204	163	136	102	90.7	81.6	65.3	54.4	46.6
	5.0	M	M	1.52	456	365	304	261	228	182	152	114	101	91.2	73.0	60.8	52.1
DG8004† DG11004 (50)	2.0	C	C	1.29	387	310	258	221	194	155	129	96.8	86.0	77.4	61.9	51.6	44.2
	2.5	M	C	1.44	432	346	288	247	216	173	144	108	96.0	86.4	69.1	57.6	49.4
	3.0	M	M	1.58	474	379	316	271	237	190	158	119	105	94.8	75.8	63.2	54.2
	4.0	M	M	1.82	546	437	364	312	273	218	182	137	121	109	87.4	72.8	62.4
	5.0	M	M	2.04	612	490	408	350	306	245	204	153	136	122	97.9	81.6	69.9
DG8005† DG11005 (50)	2.0	C	C	1.61	483	386	322	276	242	193	161	121	107	96.6	77.3	64.4	55.2
	2.5	C	C	1.80	540	432	360	309	270	216	180	135	120	108	86.4	72.0	61.7
	3.0	M	C	1.97	591	473	394	338	296	236	197	148	131	118	94.6	78.8	67.5
	4.0	M	M	2.27	681	545	454	389	341	272	227	170	151	136	109	90.8	77.8
	5.0	M	M	2.54	762	610	508	435	381	305	254	191	169	152	122	102	87.1

**Note:** Always double check your application rates. Droplet size classification shown is based on ISO 25358. Droplet size classification standard is subject to change. Tabulations are based on spraying water at 21°C. See technical information (pages 179–202) for droplet size classification, useful formulas and other technical information.

†Available in VisiFlo stainless steel only.







BROADCAST NOZZLES

## Typical Applications



**HERBICIDE**  
SOIL APPLIED  
**GOOD**  
CONTACT  
**EXCELLENT**  
SYSTEMIC  
**VERY GOOD**



**FUNGICIDE**  
CONTACT  
**EXCELLENT**  
SYSTEMIC  
**VERY GOOD**



**INSECTICIDE**  
CONTACT  
**EXCELLENT**  
SYSTEMIC  
**VERY GOOD**



**DRIFT CONTROL**  
**VERY GOOD**



**PWM APPROVED**



## FEATURES

- Dual outlet design produces two 110° flat fan spray patterns using the patented technology from the Turbo TeeJet® nozzle. The angle between each spray pattern is 60° forward and back.
- Best suited for broadcast spraying where superior leaf coverage and canopy penetration is important.
- Droplet size range is slightly larger than the same capacity Turbo TeeJet nozzle providing drift-reducing properties with increased canopy coverage and penetration.
- Available in eight VisiFlo® Polymer (VP) capacities.
- For replacement, use the automatic alignment Quick TeeJet cap and gasket 114441A-\*CELR. See page 118 for additional information.

## SPRAY PATTERN

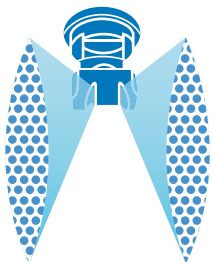

## DROPLET SIZE CLASSIFICATION

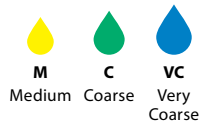

## OPTIMUM SPRAY HEIGHT

<p><b>ANGLE</b></p>	<p>50 cm SPACING</p> <p><b>HEIGHT</b></p>
	50 cm

## RECOMMENDED PRESSURE RANGE



## MATERIALS AVAILABLE



## HOW TO ORDER

Polymer with VisiFlo color-coding

**T T J 6 0 - 1 1 0 0 4 V P**

Tip Type      Spray Angle      Capacity Size      Material Code

Polymer with VisiFlo color-coding, includes Quick TeeJet cap and gasket\*

**T T J 6 0 - 1 1 0 0 3 V P - C E**

Tip Type      Spray Angle      Capacity Size      Material Code      Cap and Gasket Included

\*Reference page 118 for more caps information.



BROADCAST NOZZLES

TIP PART NO. (STRAINER MESH SIZE)	bar	DROP SIZE	CAPACITY ONE TIP IN l/min	APPLICATION RATE FOR 50 cm SPRAY TIP SPACING												
				l/ha												
				4 km/h	5 km/h	6 km/h	7 km/h	8 km/h	10 km/h	12 km/h	16 km/h	18 km/h	20 km/h	25 km/h	30 km/h	35 km/h
TTJ60-11002 (100)	1.5	C	0.56	168	134	112	96.0	84.0	67.2	56.0	42.0	37.3	33.6	26.9	22.4	19.2
	2.0	C	0.65	195	156	130	111	97.5	78.0	65.0	48.8	43.3	39.0	31.2	26.0	22.3
	3.0	M	0.79	237	190	158	135	119	94.8	79.0	59.3	52.7	47.4	37.9	31.6	27.1
	4.0	M	0.91	273	218	182	156	137	109	91.0	68.3	60.7	54.6	43.7	36.4	31.2
	5.0	M	1.02	306	245	204	175	153	122	102	76.5	68.0	61.2	49.0	40.8	35.0
TTJ60-110025 (100)	1.5	VC	0.70	210	168	140	120	105	84.0	70.0	52.5	46.7	42.0	33.6	28.0	24.0
	2.0	C	0.81	243	194	162	139	122	97.2	81.0	60.8	54.0	48.6	38.9	32.4	27.8
	3.0	C	0.99	297	238	198	170	149	119	99.0	74.3	66.0	59.4	47.5	39.6	33.9
	4.0	M	1.14	342	274	228	195	171	137	114	85.5	76.0	68.4	54.7	45.6	39.1
	5.0	M	1.28	384	307	256	219	192	154	128	96.0	85.3	76.8	61.4	51.2	43.9
TTJ60-11003 (100)	1.5	VC	0.83	249	199	166	142	125	99.6	83.0	62.3	55.3	49.8	39.8	33.2	28.5
	2.0	C	0.96	288	230	192	165	144	115	96.0	72.0	64.0	57.6	46.1	38.4	32.9
	3.0	C	1.18	354	283	236	202	177	142	118	88.5	78.7	70.8	56.6	47.2	40.5
	4.0	M	1.36	408	326	272	233	204	163	136	102	90.7	81.6	65.3	54.4	46.6
	5.0	M	1.52	456	365	304	261	228	182	152	114	101	91.2	73.0	60.8	52.1
TTJ60-11005 (50)	1.5	VC	1.12	336	269	224	192	168	134	112	84.0	74.7	67.2	53.8	44.8	38.4
	2.0	C	1.29	387	310	258	221	194	155	129	96.8	86.0	77.4	61.9	51.6	44.2
	3.0	C	1.58	474	379	316	271	237	190	158	119	105	94.8	75.8	63.2	54.2
	4.0	M	1.82	546	437	364	312	273	218	182	137	121	109	87.4	72.8	62.4
	5.0	M	2.04	612	490	408	350	306	245	204	153	136	122	97.9	81.6	69.9
TTJ60-11005 (50)	1.5	VC	1.39	417	334	278	238	209	167	139	104	92.7	83.4	66.7	55.6	47.7
	2.0	C	1.61	483	386	322	276	242	193	161	121	107	96.6	77.3	64.4	55.2
	3.0	C	1.97	591	473	394	338	296	236	197	148	131	118	94.6	78.8	67.5
	4.0	M	2.27	681	545	454	389	341	272	227	170	151	136	109	90.8	77.8
	5.0	M	2.54	762	610	508	435	381	305	254	191	169	152	122	102	87.1
TTJ60-11006 (50)	1.5	VC	1.68	504	403	336	288	252	202	168	126	112	101	80.6	67.2	57.6
	2.0	C	1.94	582	466	388	333	291	233	194	146	129	116	93.1	77.6	66.5
	3.0	C	2.37	711	569	474	406	356	284	237	178	158	142	114	94.8	81.3
	4.0	M	2.74	822	658	548	470	411	329	274	206	183	164	132	110	93.9
	5.0	M	3.06	918	734	612	525	459	367	306	230	204	184	147	122	105
TTJ60-11008 (50)	1.5	VC	2.23	669	535	446	382	335	268	223	167	149	134	107	89.2	76.5
	2.0	C	2.58	774	619	516	442	387	310	258	194	172	155	124	103	88.5
	3.0	C	3.16	948	758	632	542	474	379	316	237	211	190	152	126	108
	4.0	M	3.65	1095	876	730	626	548	438	365	274	243	219	175	146	125
	5.0	M	4.08	1224	979	816	699	612	490	408	306	272	245	196	163	140
TTJ60-11010 (50)	1.5	VC	2.79	837	670	558	478	419	335	279	209	186	167	134	112	95.7
	2.0	VC	3.23	969	775	646	554	485	388	323	242	215	194	155	129	111
	3.0	C	3.95	1185	948	790	677	593	474	395	296	263	237	190	158	135
	4.0	M	4.56	1368	1094	912	782	684	547	456	342	304	274	219	182	156
	5.0	M	5.10	1530	1224	1020	874	765	612	510	383	340	306	245	204	175
6.0	M	5.59	1677	1342	1118	958	839	671	559	419	373	335	268	224	192	

**Note:** Always double check your application rates. Droplet size classification shown is based on ISO 25358. Droplet size classification standard is subject to change. Tabulations are based on spraying water at 21°C. See technical information (pages 179–202) for droplet size classification, useful formulas and other technical information.

### LERAP RATINGS

TIP & CAPACITY	PRESSURE (bar)	STAR RATING
TTJ60-110025	1.5–2.75	★★
TTJ60-11003	1.5–2.5	★★
TTJ60-11004	1.5–2.75	★★
TTJ60-11005	1.5–3.25	★★



Visit [www.teejet.com](http://www.teejet.com) for updated charts.



BROADCAST NOZZLES

### Typical Applications



**HERBICIDE**  
SOIL APPLIED  
**VERY GOOD**  
CONTACT  
**VERY GOOD**  
SYSTEMIC  
**EXCELLENT**



**FUNGICIDE**  
CONTACT  
**GOOD**  
SYSTEMIC  
**EXCELLENT**



**INSECTICIDE**  
CONTACT  
**GOOD**  
SYSTEMIC  
**EXCELLENT**



**DRIFT CONTROL**  
**EXCELLENT**



**PWM APPROVED**



### FEATURES

- Dual tapered edge spray tip with air-induction technology.
- The combination of the dual symmetric 110° flat fan pattern and the 60° angle between spray pattern in addition to the greater number of droplets results in a superior crop coverage and penetration, while providing excellent drift control.
- Available in nine VisiFlo® Polymer (VP) capacities.
- Automatic spray alignment with Quick TeeJet cap and gasket 114443A-\*CELR (02 to 06) or 114502A-\*CELR (08 to 15). See page 118 for additional information.

### SPRAY PATTERN

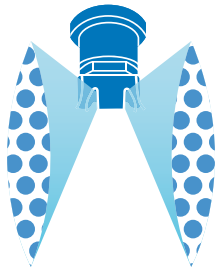

### DROPLET SIZE CLASSIFICATION

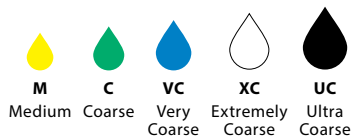

### OPTIMUM SPRAY HEIGHT

ANGLE	50 cm SPACING HEIGHT
110°	50 cm

### RECOMMENDED PRESSURE RANGE



### MATERIALS AVAILABLE



### HOW TO ORDER

Polymer with VisiFlo color-coding

**A I T T J 6 0 - 1 1 0 0 4 V P**

Tip Type      Spray Angle      Capacity Size      Material Code

Polymer with VisiFlo color-coding, includes Quick TeeJet cap and gasket\*

**A I T T J 6 0 - 1 1 0 0 4 V P - C E**

Tip Type      Spray Angle      Capacity Size      Material Code      Cap and Gasket Included

\*Reference page 118 for more caps information.



BROADCAST NOZZLES

TIP PART NO. (STRAINER MESH SIZE)	bar	DROP SIZE	CAPACITY ONE TIP IN l/min	APPLICATION RATE FOR 50 cm SPRAY TIP SPACING												
				l/ha												
				4 km/h	5 km/h	6 km/h	7 km/h	8 km/h	10 km/h	12 km/h	16 km/h	18 km/h	20 km/h	25 km/h	30 km/h	35 km/h
AITTJ60-11002VP (100)	1.5	XC	0.56	168	134	112	96.0	84.0	67.2	56.0	42.0	37.3	33.6	26.9	22.4	19.2
	2.0	VC	0.65	195	156	130	111	97.5	78.0	65.0	48.8	43.3	39.0	31.2	26.0	22.3
	3.0	VC	0.79	237	190	158	135	119	94.8	79.0	59.3	52.7	47.4	37.9	31.6	27.1
	4.0	C	0.91	273	218	182	156	137	109	91.0	68.3	60.7	54.6	43.7	36.4	31.2
	5.0	C	1.02	306	245	204	175	153	122	102	76.5	68.0	61.2	49.0	40.8	35.0
	6.0	M	1.12	336	269	224	192	168	134	112	84.0	74.7	67.2	53.8	44.8	38.4
AITTJ60-110025VP (100)	1.5	XC	0.70	210	168	140	120	105	84.0	70.0	52.5	46.7	42.0	33.6	28.0	24.0
	2.0	VC	0.81	243	194	162	139	122	97.2	81.0	60.8	54.0	48.6	38.9	32.4	27.8
	3.0	VC	0.99	297	238	198	170	149	119	99.0	74.3	66.0	59.4	47.5	39.6	33.9
	4.0	C	1.14	342	274	228	195	171	137	114	85.5	76.0	68.4	54.7	45.6	39.1
	5.0	C	1.28	384	307	256	219	192	154	128	96.0	85.3	76.8	61.4	51.2	43.9
	6.0	C	1.40	420	336	280	240	210	168	140	105	93.3	84.0	67.2	56.0	48.0
AITTJ60-11003VP (50)	1.5	XC	0.83	249	199	166	142	125	99.6	83.0	62.3	55.3	49.8	39.8	33.2	28.5
	2.0	XC	0.96	288	230	192	165	144	115	96.0	72.0	64.0	57.6	46.1	38.4	32.9
	3.0	VC	1.18	354	283	236	202	177	142	118	88.5	78.7	70.8	56.1	47.2	40.5
	4.0	C	1.36	408	326	272	233	204	163	136	102	90.7	81.6	65.3	54.4	46.6
	5.0	C	1.52	456	365	304	261	228	182	152	114	101	91.2	73.0	60.8	52.1
	6.0	C	1.67	501	401	334	286	251	200	167	125	111	100	80.2	66.8	57.3
AITTJ60-11004VP (50)	1.5	XC	1.12	336	269	224	192	168	134	112	84.0	74.7	67.2	53.8	44.8	38.4
	2.0	XC	1.29	387	310	258	221	194	155	129	96.8	86.0	77.4	61.9	51.6	44.2
	3.0	VC	1.58	474	379	316	271	237	190	158	119	105	94.8	75.8	63.2	54.2
	4.0	C	1.82	546	437	364	312	273	218	182	137	121	109	87.4	72.8	62.4
	5.0	C	2.04	612	490	408	350	306	245	204	153	136	122	97.9	81.6	69.9
	6.0	C	2.23	669	535	446	382	335	268	223	167	149	134	107	89.2	76.5
AITTJ60-11005VP (50)	1.5	XC	1.39	417	334	278	238	209	167	139	104	92.7	83.4	66.7	55.6	47.7
	2.0	XC	1.61	483	386	322	276	242	193	161	121	107	96.6	77.3	64.4	55.2
	3.0	VC	1.97	591	473	394	338	296	236	197	148	131	118	94.6	78.8	67.5
	4.0	VC	2.27	681	545	454	389	341	272	227	170	151	136	109	90.8	77.8
	5.0	C	2.54	762	610	508	435	381	305	254	191	169	152	122	102	87.1
	6.0	C	2.79	837	670	558	478	419	335	279	209	186	167	134	112	95.7
AITTJ60-11006VP (50)	1.5	XC	1.68	504	403	336	288	252	202	168	126	112	101	80.6	67.2	57.6
	2.0	XC	1.94	582	466	388	333	291	233	194	146	129	116	93.1	77.6	66.5
	3.0	VC	2.37	711	569	474	406	356	284	237	178	158	142	114	94.8	81.3
	4.0	VC	2.74	822	658	548	470	411	329	274	206	183	164	132	110	93.9
	5.0	C	3.06	918	734	612	525	459	367	306	230	204	184	147	122	105
	6.0	C	3.35	1005	804	670	574	503	402	335	251	223	201	161	134	115
AITTJ60-11008VP (50)	1.5	UC	2.23	669	535	446	382	335	268	223	167	149	134	107	89.2	76.5
	2.0	UC	2.58	774	619	516	442	387	310	258	194	172	155	124	103	88.5
	3.0	XC	3.16	948	758	632	542	474	379	316	237	211	190	152	126	108
	4.0	XC	3.65	1095	876	730	626	548	438	365	274	243	219	175	146	125
	5.0	VC	4.08	1224	979	816	699	612	490	408	306	272	245	196	163	140
	6.0	VC	4.47	1341	1073	894	766	671	536	447	335	298	268	215	179	153
AITTJ60-11010VP (50)	1.5	UC	2.79	837	670	558	478	419	335	279	209	186	167	134	112	95.7
	2.0	UC	3.23	969	775	646	554	485	388	323	242	215	194	155	129	111
	3.0	XC	3.95	1185	948	790	677	593	474	395	296	263	237	190	158	135
	4.0	XC	4.56	1368	1094	912	782	684	547	456	342	304	274	219	182	156
	5.0	VC	5.10	1530	1224	1020	874	765	612	510	383	340	306	245	204	175
	6.0	VC	5.59	1677	1342	1118	958	839	671	559	419	373	335	268	224	192
AITTJ60-11015VP (50)	1.5	UC	4.19	1257	1006	838	718	629	503	419	314	279	251	201	168	144
	2.0	UC	4.83	1449	1159	966	828	725	580	483	362	322	290	232	193	166
	3.0	XC	5.92	1776	1421	1184	1015	888	710	592	444	395	355	284	237	203
	4.0	XC	6.84	2052	1642	1368	1173	1026	821	684	513	456	410	328	274	235
	5.0	VC	7.64	2292	1834	1528	1310	1146	917	764	573	509	458	367	306	262
	6.0	VC	8.37	2511	2009	1674	1435	1256	1004	837	628	558	502	402	335	287

Note: Always double check your application rates. Droplet size classification shown is based on ISO 25358. Droplet size classification standard is subject to change. Tabulations are based on spraying water at 21°C. See technical information (pages 179–202) for droplet size classification, useful formulas and other technical information.

### LERAP RATINGS

TIP & CAPACITY	PRESSURE (bar)	STAR RATING	TIP & CAPACITY	PRESSURE (bar)	STAR RATING
AITTJ60-11002	1.5–2.25	★★★★	AITTJ60-11004	1.5–4.0	★★★★
	2.26–4.0	★★★		4.01–5.0	★★★
AITTJ60-110025	1.5–2.5	★★★★	AITTJ60-11005	1.5–5.0	★★★★
	2.51–4.0	★★★			
AITTJ60-11003	1.5–2.0	★★★★			
	2.01–4.5	★★★			



Visit [www.teejet.com](http://www.teejet.com) for updated charts.



### Typical Applications



**FUNGICIDE**  
CONTACT  
**EXCELLENT**  
SYSTEMIC  
**VERY GOOD**



**DRIFT CONTROL**  
**VERY GOOD**



### FEATURES

- Provides excellent penetration and seed head coverage for fungicide spraying on cereal crops.
- AI3070 produces two wide angle, flat spray patterns for uniform coverage in broadcast applications.
- 30° forward tilted spray penetrates dense crop canopies, while the backward tilted 70° spray maximizes coverage of the crop seed head.
- Drift resistant droplets are produced through the use of a Venturi air aspirator.
- Available in six VisiFlo® Polymer (VP) capacities.
- Due to the spray tip design, the boom height must be reduced when compared to other flat spray tips (see table below).
- Removable pre-orifice for fast and easy cleaning.
- Automatic spray alignment with Quick TeeJet cap and gasket 98579-1-NYR. Reference page 118 for more information.

### SPRAY PATTERN

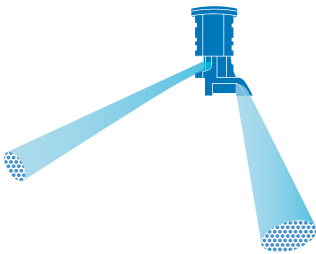

### DROPLET SIZE CLASSIFICATION

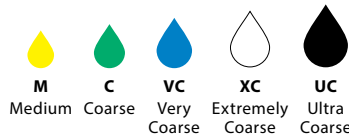

### OPTIMUM SPRAY HEIGHT

 HEIGHT 30 cm	 50 cm SPACING HEIGHT 50 cm
---------------------	--------------------------------------

### RECOMMENDED PRESSURE RANGE



1.5-6 bar

### MATERIALS AVAILABLE



### HOW TO ORDER

Polymer with VisiFlo color-coding  
**A I 3 0 7 0 - 0 4 V P**

Tip Type      Capacity Size      Material Code

Polymer with VisiFlo color-coding, includes Quick TeeJet cap and gasket\*

**A I 3 0 7 0 - 0 3 V P - C**

Tip Type      Capacity Size      Material Code      Cap and Gasket Included

\*Reference page 118 for more caps information.

TIP PART NO. (STRAINER MESH SIZE)	bar	DROP SIZE	CAPACITY ONE TIP IN l/min	APPLICATION RATE FOR 50 cm SPRAY TIP SPACING												
				l/ha												
				4 km/h	5 km/h	6 km/h	7 km/h	8 km/h	10 km/h	12 km/h	16 km/h	18 km/h	20 km/h	25 km/h	30 km/h	35 km/h
AI3070-015VP (100)	1.5	VC	0.42	126	101	84.0	72.0	63.0	50.4	42.0	31.5	28.0	25.2	20.2	16.8	14.4
	2.0	VC	0.48	144	115	96.0	82.3	72.0	57.6	48.0	36.0	32.0	28.8	23.0	19.2	16.5
	3.0	C	0.59	177	142	118	101	88.5	70.8	59.0	44.3	39.3	35.4	28.3	23.6	20.2
	4.0	C	0.68	204	163	136	117	102	81.6	68.0	51.0	45.3	40.8	32.6	27.2	23.3
	5.0	M	0.76	228	182	152	130	114	91.2	76.0	57.0	50.7	45.6	36.5	30.4	26.1
	6.0	M	0.83	249	199	166	142	125	99.6	83.0	62.3	55.3	49.8	39.8	33.2	28.5
AI3070-02VP (100)	1.5	XC	0.56	168	134	112	96.0	84.0	67.2	56.0	42.0	37.3	33.6	26.9	22.4	19.2
	2.0	VC	0.65	195	156	130	111	97.5	78.0	65.0	48.8	43.3	39.0	31.2	26.0	22.3
	3.0	C	0.79	237	190	158	135	119	94.8	79.0	59.3	52.7	47.4	37.9	31.6	27.1
	4.0	C	0.91	273	218	182	156	137	109	91.0	68.3	60.7	54.6	43.7	36.4	31.2
	5.0	M	1.02	306	245	204	175	153	122	102	76.5	68.0	61.2	49.0	40.8	35.0
	6.0	M	1.12	336	269	224	192	168	134	112	84.0	74.7	67.2	53.8	44.8	38.4
AI3070-025VP (100)	1.5	XC	0.70	210	168	140	120	105	84.0	70.0	52.5	46.7	42.0	33.6	28.0	24.0
	2.0	VC	0.81	243	194	162	139	122	97.2	81.0	60.8	54.0	48.6	38.9	32.4	27.8
	3.0	VC	0.99	297	238	198	170	149	119	99.0	74.3	66.0	59.4	47.5	39.6	33.9
	4.0	C	1.14	342	274	228	195	171	137	114	85.5	76.0	68.4	54.7	45.6	39.1
	5.0	C	1.28	384	307	256	219	192	154	128	96.0	85.3	76.8	61.4	51.2	43.9
	6.0	M	1.40	420	336	280	240	210	168	140	105	93.3	84.0	67.2	56.0	48.0
AI3070-03VP (50)	1.5	XC	0.83	249	199	166	142	125	99.6	83.0	62.3	55.3	49.8	39.8	33.2	28.5
	2.0	XC	0.96	288	230	192	165	144	115	96.0	72.0	64.0	57.6	46.1	38.4	32.9
	3.0	VC	1.18	354	283	236	202	177	142	118	88.5	78.7	70.8	56.6	47.2	40.5
	4.0	C	1.36	408	326	272	233	204	163	136	102	90.7	81.6	65.3	54.4	46.6
	5.0	C	1.52	456	365	304	261	228	182	152	114	101	91.2	73.0	60.8	52.1
	6.0	C	1.67	501	401	334	286	251	200	167	125	111	100	80.2	66.8	57.3
AI3070-04VP (50)	1.5	XC	1.12	336	269	224	192	168	134	112	84.0	74.7	67.2	53.8	44.8	38.4
	2.0	XC	1.29	387	310	258	221	194	155	129	96.8	86.0	77.4	61.9	51.6	44.2
	3.0	VC	1.58	474	379	316	271	237	190	158	119	105	94.8	75.8	63.2	54.2
	4.0	VC	1.82	546	437	364	312	273	218	182	137	121	109	87.4	72.8	62.4
	5.0	C	2.04	612	490	408	350	306	245	204	153	136	122	97.9	81.6	69.9
	6.0	C	2.23	669	535	446	382	335	268	223	167	149	134	107	89.2	76.5
AI3070-05VP (50)	1.5	UC	1.39	417	334	278	238	209	167	139	104	92.7	83.4	66.7	55.6	47.7
	2.0	XC	1.61	483	386	322	276	242	193	161	121	107	96.6	77.3	64.4	55.2
	3.0	VC	1.97	591	473	394	338	296	236	197	148	131	118	94.6	78.8	67.5
	4.0	VC	2.27	681	545	454	389	341	272	227	170	151	136	109	90.8	77.8
	5.0	C	2.54	762	610	508	435	381	305	254	191	169	152	122	102	87.1
	6.0	C	2.79	837	670	558	478	419	335	279	209	186	167	134	112	95.7

**Note:** Always double check your application rates. Droplet size classification shown is based on ISO 25358. Droplet size classification standard is subject to change. Tabulations are based on spraying water at 21°C. See technical information (pages 179–202) for droplet size classification, useful formulas and other technical information.

### LERAP RATINGS

TIP & CAPACITY	PRESSURE (bar)	STAR RATING
AI3070-015VP	1.5–2.0	★★
AI3070-02VP	1.5–2.0	★★
AI3070-025VP	1.5–3.0	★★
AI3070-03VP	1.5–3.0	★★
AI3070-04VP	1.5–2.0	★★★
	2.5–5.0	★★
AI3070-05VP	1.5–4.0	★★★★
	4.5–6.0	★★





BROADCAST NOZZLES

## Typical Applications



**HERBICIDE**  
CONTACT  
**EXCELLENT**



**FUNGICIDE**  
CONTACT  
**EXCELLENT**



**INSECTICIDE**  
CONTACT  
**EXCELLENT**



**PWM**  
**APPROVED**



## FEATURES

- Penetrates crop residue or dense foliage.
- Smaller droplets for thorough coverage.
- Better spray distribution along boom than with hollow cone nozzles.
- Available in stainless steel with VisiFlo® color-coding in 65°, 80° and 110° spray angles.
- See pages 70–71 for TwinJet even flat spray tips.
- Automatic spray alignment with 114443A\*-CELR Quick TeeJet® cap and gasket. Reference page 118 for more information.

## SPRAY PATTERN

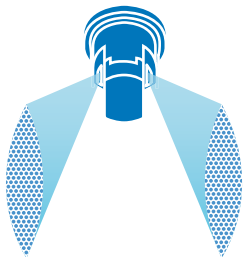

## DROPLET SIZE CLASSIFICATION

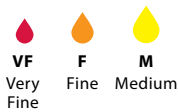

## OPTIMUM SPRAY HEIGHT

ANGLE	HEIGHT
65°	90 cm
80°	75 cm
110°	50 cm

## RECOMMENDED PRESSURE RANGE



## MATERIALS AVAILABLE

**VS** STAINLESS STEEL

## HOW TO ORDER

Stainless Steel with VisiFlo color-coding

**T J 6 0 - 8 0 0 2 V S**

Tip Type    Spray Angle    Capacity Size    Material Code



BROADCAST NOZZLES

TIP PART NO. (STRAINER MESH SIZE)	bar	DROP SIZE		CAPACITY ONE TIP IN l/min	APPLICATION RATE FOR 50 cm SPRAY TIP SPACING												
		80°	110°		l/ha												
					4 km/h	5 km/h	6 km/h	7 km/h	8 km/h	10 km/h	12 km/h	16 km/h	18 km/h	20 km/h	25 km/h	30 km/h	35 km/h
TJ60-6501 TJ60-8001 (100)	2.0	F		0.32	96.0	76.8	64.0	54.9	48.0	38.4	32.0	24.0	21.3	19.2	15.4	12.8	11.0
	2.5	F		0.36	108	86.4	72.0	61.7	54.0	43.2	36.0	27.0	24.0	21.6	17.3	14.4	12.3
	3.0	VF		0.39	117	93.6	78.0	66.9	58.5	46.8	39.0	29.3	26.0	23.4	18.7	15.6	13.4
	3.5	VF		0.42	126	101	84.0	72.0	63.0	50.4	42.0	31.5	28.0	25.2	20.2	16.8	14.4
TJ60-650134 (100)	2.0			0.43	129	103	86.0	73.7	64.5	51.6	43.0	32.3	28.7	25.8	20.6	17.2	14.7
	2.5			0.48	144	115	96.0	82.3	72.0	57.6	48.0	36.0	32.0	28.8	23.0	19.2	16.5
	3.0			0.53	159	127	106	90.9	79.5	63.6	53.0	39.8	35.3	31.8	25.4	21.2	18.2
	3.5			0.57	171	137	114	97.7	85.5	68.4	57.0	42.8	38.0	34.2	27.4	22.8	19.5
	4.0			0.61	183	146	122	105	91.5	73.2	61.0	45.8	40.7	36.6	29.3	24.4	20.9
TJ60-6502 TJ60-8002 TJ60-11002 (100)	2.0	F	F	0.65	195	156	130	111	97.5	78.0	65.0	48.8	43.3	39.0	31.2	26.0	22.3
	2.5	F	F	0.72	216	173	144	123	108	86.4	72.0	54.0	48.0	43.2	34.6	28.8	24.7
	3.0	F	F	0.79	237	190	158	135	119	94.8	79.0	59.3	52.7	47.4	37.9	31.6	27.1
	3.5	F	F	0.85	255	204	170	146	128	102	85.0	63.8	56.7	51.0	40.8	34.0	29.1
	4.0	F	F	0.91	273	218	182	156	137	109	91.0	68.3	60.7	54.6	43.7	36.4	31.2
TJ60-6503 TJ60-8003 TJ60-11003 (100)	2.0	F	F	0.96	288	230	192	165	144	115	96.0	72.0	64.0	57.6	46.1	38.4	32.9
	2.5	F	F	1.08	324	259	216	185	162	130	108	81.0	72.0	64.8	51.8	43.2	37.0
	3.0	F	F	1.18	354	283	236	202	177	142	118	88.5	78.7	70.8	56.6	47.2	40.5
	3.5	F	F	1.27	381	305	254	218	191	152	127	95.3	84.7	76.2	61.0	50.8	43.5
	4.0	F	F	1.36	408	326	272	233	204	163	136	102	90.7	81.6	65.3	54.4	46.6
TJ60-6504 TJ60-8004 TJ60-11004 (50)	2.0	F	F	1.29	387	310	258	221	194	155	129	96.8	86.0	77.4	61.9	51.6	44.2
	2.5	F	F	1.44	432	346	288	247	216	173	144	108	96.0	86.4	69.1	57.6	49.4
	3.0	F	F	1.58	474	379	316	271	237	190	158	119	105	94.8	75.8	63.2	54.2
	3.5	F	F	1.71	513	410	342	293	257	205	171	128	114	103	82.1	68.4	58.6
	4.0	F	F	1.82	546	437	364	312	273	218	182	137	121	109	87.4	72.8	62.4
TJ60-8005 TJ60-11005 (50)	2.0	M	M	1.61	483	386	322	276	242	193	161	121	107	96.6	77.3	64.4	55.2
	2.5	M	M	1.80	540	432	360	309	270	216	180	135	120	108	86.4	72.0	61.7
	3.0	M	M	1.97	591	473	394	338	296	236	197	148	131	118	94.6	78.8	67.5
	3.5	F	F	2.13	639	511	426	365	320	256	213	160	142	128	102	85.2	73.0
	4.0	F	F	2.27	681	545	454	389	341	272	227	170	151	136	109	90.8	77.8
TJ60-6506 TJ60-8006 TJ60-11006 (50)	2.0	M	M	1.94	582	466	388	333	291	233	194	146	129	116	93.1	77.6	66.5
	2.5	M	M	2.16	648	518	432	370	324	259	216	162	144	130	104	86.4	74.1
	3.0	M	M	2.37	711	569	474	406	356	284	237	178	158	142	114	94.8	81.3
	3.5	M	M	2.56	768	614	512	439	384	307	256	192	171	154	123	102	87.8
	4.0	M	M	2.74	822	658	548	470	411	329	274	206	183	164	132	110	93.9
TJ60-6508 TJ60-8008 TJ60-11008 (50)	2.0	M	M	2.58	774	619	516	442	387	310	258	194	172	155	124	103	88.5
	2.5	M	M	2.88	864	691	576	494	432	346	288	216	192	173	138	115	98.7
	3.0	M	M	3.16	948	758	632	542	474	379	316	237	211	190	152	126	108
	3.5	M	M	3.41	1023	818	682	585	512	409	341	256	227	205	164	136	117
	4.0	M	M	3.65	1095	876	730	626	548	438	365	274	243	219	175	146	125
TJ60-8010 TJ60-11010 (50)	2.0	M	M	3.23	969	775	646	554	485	388	323	242	215	194	155	129	111
	2.5	M	M	3.61	1083	866	722	619	542	433	361	271	241	217	173	144	124
	3.0	M	M	3.95	1185	948	790	677	593	474	395	296	263	237	190	158	135
	3.5	M	M	4.27	1281	1025	854	732	641	512	427	320	285	256	205	171	146
	4.0	M	M	4.56	1368	1094	912	782	684	547	456	342	304	274	219	182	156

**Note:** Always double check your application rates. Droplet size classification shown is based on ISO 25358. Droplet size classification standard is subject to change. Tabulations are based on spraying water at 21°C. See technical information (pages 179–202) for droplet size classification, useful formulas and other technical information.





## Typical Applications



**HERBICIDE**  
SOIL APPLIED  
**VERY GOOD**  
CONTACT  
**VERY GOOD**  
SYSTEMIC  
**VERY GOOD**



**FUNGICIDE**  
CONTACT  
**VERY GOOD**  
SYSTEMIC  
**EXCELLENT**



**INSECTICIDE**  
CONTACT  
**VERY GOOD**  
SYSTEMIC  
**EXCELLENT**



**FERTILIZER**  
BROADCAST  
**GOOD**



**DRIFT CONTROL**  
**GOOD**



## FEATURES

- Dual 110°, tapered edge, flat fan spray patterns spraying 60° forward to back providing better canopy coverage and penetration in broadcast spraying applications.
- DG TwinJet offers larger droplets and improved drift control compared to a standard twin flat spray tip of equal capacity.
- Removable polymer pre-orifice.

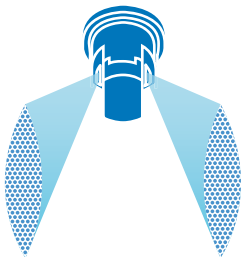

## SPRAY PATTERN



## DROPLET SIZE CLASSIFICATION



## OPTIMUM SPRAY HEIGHT

 ANGLE	50 cm SPACING  HEIGHT
110°	50 cm

## RECOMMENDED PRESSURE RANGE



## MATERIALS AVAILABLE



## HOW TO ORDER

Stainless Steel with VisiFlo® color-coding

D G T J 6 0 - 1 1 0 0 4 V S

Tip Type

Spray Angle

Capacity Size

Material Code

TIP PART NO. (STRAINER MESH SIZE)	bar	DROP SIZE	CAPACITY ONE TIP IN l/min	APPLICATION RATE FOR 50 cm SPRAY TIP SPACING												
				l/ha												
				4 km/h	5 km/h	6 km/h	7 km/h	8 km/h	10 km/h	12 km/h	16 km/h	18 km/h	20 km/h	25 km/h	30 km/h	35 km/h
DGTJ60-110015 (100)	2.0	M	0.48	144	115	96.0	82.3	72.0	57.6	48.0	36.0	32.0	28.8	23.0	19.2	16.5
	2.5	M	0.54	162	130	108	92.6	81.0	64.8	54.0	40.5	36.0	32.4	25.9	21.6	18.5
	3.0	F	0.59	177	142	118	101	88.5	70.8	59.0	44.3	39.3	35.4	28.3	23.6	20.2
	3.5	F	0.64	192	154	128	110	96.0	76.8	64.0	48.0	42.7	38.4	30.7	25.6	21.9
	4.0	F	0.76	228	182	152	130	114	91.2	76.0	57.0	50.7	45.6	36.5	30.4	26.1
DGTJ60-11002 (100)	2.0	M	0.65	195	156	130	111	97.5	78.0	65.0	48.8	43.3	39.0	31.2	26.0	22.3
	2.5	M	0.72	216	173	144	123	108	86.4	72.0	54.0	48.0	43.2	34.6	28.8	24.7
	3.0	M	0.79	237	190	158	135	119	94.8	79.0	59.3	52.7	47.4	37.9	31.6	27.1
	3.5	M	0.85	255	204	170	146	128	102	85.0	63.8	56.7	51.0	40.8	34.0	29.1
	4.0	M	0.91	273	245	182	175	137	109	91.0	68.3	60.7	54.6	43.7	36.4	31.2
DGTJ60-11003 (100)	2.0	M	0.96	288	230	192	165	144	115	96.0	72.0	64.0	57.6	46.1	38.4	32.9
	2.5	M	1.08	324	259	216	185	162	130	108	81.0	72.0	64.8	51.8	43.2	37.0
	3.0	M	1.18	354	283	236	202	177	142	118	88.5	78.7	70.8	56.6	47.2	40.5
	3.5	M	1.27	381	305	254	218	191	152	127	95.3	84.7	76.2	61.0	50.8	43.5
	4.0	M	1.36	408	365	272	261	204	163	136	102	90.7	81.6	65.3	54.4	46.6
DGTJ60-11004 (50)	2.0	C	1.29	387	310	258	221	194	155	129	96.8	86.0	77.4	61.9	51.6	44.2
	2.5	C	1.44	432	346	288	247	216	173	144	108	96.0	86.4	69.1	57.6	49.4
	3.0	C	1.58	474	379	316	271	237	190	158	119	105	94.8	75.8	63.2	54.2
	3.5	M	1.71	513	410	342	293	257	205	171	128	114	103	82.1	68.4	58.6
	4.0	M	1.82	546	490	364	350	273	218	182	137	121	109	87.4	72.8	62.4
DGTJ60-11006 (50)	2.0	C	1.94	582	386	388	276	291	233	194	146	129	116	93.1	77.6	66.5
	2.5	C	1.80	540	432	360	309	270	216	180	135	120	108	86.4	72.0	61.7
	3.0	C	2.37	711	473	474	338	356	284	237	178	158	142	114	94.8	81.3
	3.5	M	2.56	768	614	512	439	384	307	256	192	171	154	123	102	87.8
	4.0	M	2.74	822	610	548	435	411	329	274	206	183	164	132	110	93.9
DGTJ60-11008 (50)	2.0	C	2.58	774	619	516	442	387	310	258	194	172	155	124	103	88.5
	2.5	C	2.88	864	691	576	494	432	346	288	216	192	173	138	115	98.7
	3.0	C	3.16	948	758	632	642	474	379	316	237	211	190	152	126	108
	3.5	M	3.41	1023	818	682	585	512	409	341	256	227	205	164	136	117
	4.0	M	3.65	1095	876	730	626	548	438	365	274	243	219	175	146	125

**Note:** Always double check your application rates. Droplet size classification shown is based on ISO 25358. Droplet size classification standard is subject to change. Tabulations are based on spraying water at 21°C. See technical information (pages 179–202) for droplet size classification, useful formulas and other technical information.



### Typical Applications



**HERBICIDE**  
SOIL APPLIED  
**EXCELLENT**  
SYSTEMIC  
**VERY GOOD**



**FERTILIZER**  
BROADCAST  
**VERY GOOD**



**DRIFT CONTROL**  
**EXCELLENT**



### FEATURES

- Excellent spray distribution for uniform coverage along the boom.
- Spray tip design incorporates a pre-orifice to produce larger droplets for less drift.
- Large, round orifice reduces clogging.
- Available in seven VisiFlo® Stainless Steel (VS) and seven VisiFlo Polymer (VP) capacities.
- Can be used with 114445A-\*CELR Quick TeeJet® cap and gasket for automatic alignment. Reference page 118 for more information.

### SPRAY PATTERN

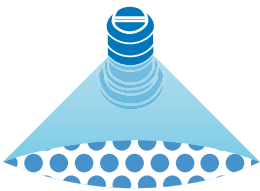

### DROPLET SIZE CLASSIFICATION

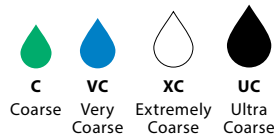

### OPTIMUM SPRAY HEIGHT

HEIGHT	SPACING
60 cm*	50 cm
75 cm*	75 cm
100 cm*	100 cm

\*Wide angle spray nozzle height is influenced by nozzle orientation. The critical factor is to achieve a minimum 30% overlap.

### RECOMMENDED PRESSURE RANGE



### MATERIALS AVAILABLE

- VS** STAINLESS STEEL
- VP** POLYMER

### HOW TO ORDER

Stainless Steel with VisiFlo color-coding

T F - V S 4

Tip Type | Material Code | Capacity Size

Polymer with VisiFlo color-coding

T F - V P 4

Tip Type | Material Code | Capacity Size

TIP PART NO. (STRAINER MESH SIZE)	bar	DROP SIZE		CAPACITY ONE TIP IN l/min	APPLICATION RATE FOR 75 cm SPRAY TIP SPACING										APPLICATION RATE FOR 100 cm SPRAY TIP SPACING									
		VS	VP		l/ha										l/ha									
					4 km/h	6 km/h	8 km/h	10 km/h	12 km/h	16 km/h	20 km/h	25 km/h	4 km/h	6 km/h	8 km/h	10 km/h	12 km/h	16 km/h	20 km/h	25 km/h				
TF-†2 (50)	1.0	UC	XC	0.91	182	121	91.0	72.8	60.7	45.5	36.4	29.1	137	91.0	68.3	54.6	45.5	34.1	27.3	21.8				
	1.5	UC	XC	1.11	222	148	111	88.8	74.0	55.5	44.4	35.5	167	111	83.3	66.6	55.5	41.6	33.3	26.6				
	2.0	XC	VC	1.29	258	172	129	103	86.0	64.5	51.6	41.3	194	129	96.8	77.4	64.5	48.4	38.7	31.0				
	2.5	VC	VC	1.44	288	192	144	115	96.0	72.0	57.6	46.1	216	144	108	86.4	72.0	54.0	43.2	34.6				
	3.0	VC	C	1.58	316	211	158	126	105	79.0	63.2	50.6	237	158	119	94.8	79.0	59.3	47.4	37.9				
TF-†2.5 (50)	1.0	UC	XC	1.14	228	152	114	91.2	76.0	57.0	45.6	36.5	171	114	85.5	68.4	57.0	42.8	34.2	27.4				
	1.5	UC	XC	1.40	280	187	140	112	93.3	70.0	56.0	44.8	210	140	105	84.0	70.0	52.5	42.0	33.6				
	2.0	XC	VC	1.61	322	215	161	129	107	80.5	64.4	51.5	242	161	121	96.6	80.5	60.4	48.3	38.6				
	2.5	VC	VC	1.80	360	240	180	144	120	90.0	72.0	57.6	270	180	135	108	90.0	67.5	54.0	43.2				
	3.0	VC	C	1.97	394	263	197	158	131	98.5	78.8	63.0	296	197	148	118	98.5	73.9	59.1	47.3				
TF-†3 (50)	1.0	UC	XC	1.37	274	183	137	110	91.3	68.5	54.8	43.8	206	137	103	82.2	68.5	51.4	41.1	32.9				
	1.5	UC	XC	1.68	336	224	168	134	112	84.0	67.2	53.8	252	168	126	101	84.0	63.0	50.4	40.3				
	2.0	XC	VC	1.94	388	259	194	155	129	97.0	77.6	62.1	291	194	146	116	97.0	72.8	58.2	46.6				
	2.5	XC	VC	2.17	434	289	217	174	145	109	86.8	69.4	326	217	163	130	109	81.4	65.1	52.1				
	3.0	VC	VC	2.37	474	316	237	190	158	119	94.8	75.8	356	237	178	142	119	88.9	71.1	56.9				
TF-†4 (50)	1.0	UC	UC	1.82	364	243	182	146	121	91.0	72.8	58.2	273	182	137	109	91.0	68.3	54.6	43.7				
	1.5	UC	XC	2.23	446	297	223	178	149	112	89.2	71.4	335	223	167	134	112	83.6	66.9	53.5				
	2.0	XC	XC	2.57	514	343	257	206	171	129	103	82.2	386	257	193	154	129	96.4	77.1	61.7				
	2.5	XC	VC	2.88	576	384	288	230	192	144	115	92.2	432	288	216	173	144	108	86.4	69.1				
	3.0	VC	VC	3.15	630	420	315	252	210	158	126	101	473	315	236	189	158	118	94.5	75.6				
TF-†5	1.0	UC	UC	2.28	456	304	228	182	152	114	91.2	73.0	342	228	171	137	114	85.5	68.4	54.7				
	1.5	UC	XC	2.79	558	372	279	223	186	140	112	89.3	419	279	209	167	140	105	83.7	67.0				
	2.0	XC	XC	3.22	644	429	322	258	215	161	129	103	483	322	242	193	161	121	96.6	77.3				
	2.5	XC	VC	3.60	720	480	360	288	240	180	144	115	540	360	270	216	180	135	108	86.4				
	3.0	VC	VC	3.95	790	527	395	316	263	198	158	126	593	395	296	237	198	148	119	94.8				
TF-†7.5	1.0	UC	UC	3.42	684	456	342	274	228	171	137	109	513	342	257	205	171	128	103	82.1				
	1.5	UC	XC	4.19	838	559	419	335	279	210	168	134	629	419	314	251	210	157	126	101				
	2.0	XC	XC	4.84	968	645	484	387	323	242	194	155	726	484	363	290	242	182	145	116				
	2.5	XC	VC	5.41	1082	721	541	433	361	271	216	173	812	541	406	325	271	203	162	130				
	3.0	VC	VC	5.92	1184	789	592	474	395	296	237	189	888	592	444	355	296	222	178	142				
TF-†10	1.0	UC	UC	4.56	912	608	456	365	304	228	182	146	684	456	342	274	228	171	137	109				
	1.5	UC	XC	5.58	1116	744	558	446	372	279	223	179	837	558	419	335	279	209	167	134				
	2.0	XC	XC	6.45	1290	860	645	516	430	323	258	206	968	645	484	387	323	242	194	155				
	2.5	XC	VC	7.21	1442	961	721	577	481	361	288	231	1082	721	541	433	361	270	216	173				
	3.0	VC	VC	7.90	1580	1053	790	632	527	395	316	253	1185	790	593	474	395	296	237	190				

**Note:** Always double check your application rates. Droplet size classification shown is based on ISO 25358. Droplet size classification standard is subject to change. Tabulations are based on spraying water at 21°C. See technical information (pages 179–202) for droplet size classification, useful formulas and other technical information. †Specify material.

### QCT CAM LEVER COUPLING ADAPTER

- Provides easy changeover from high capacity to lower capacity nozzles.
- Adapter fits standard 3/4" cam lever coupling.
- Corrosion-resistant stainless steel and polypropylene construction.
- Rated up to 7 bar.
- Use QJT-NYB to retrofit to Quick TeeJet.

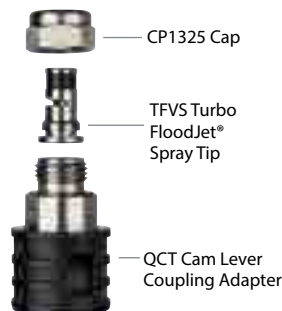



# Quick Turbo FloodJet® WIDE ANGLE FLAT SPRAY

BROADCAST NOZZLES

## Typical Applications



**HERBICIDE**  
SOIL APPLIED  
**EXCELLENT**



**DRIFT**  
**CONTROL**  
**EXCELLENT**



## FEATURES

- Turbulence chamber creates a dramatic improvement in pattern uniformity.
- Pre-orifice design produces larger droplets for reduced drift.
- Large, round orifice reduces clogging.
- 32 mm diameter tip body fits into 3/4" cam lever coupling.
- Grooved side molding for automatic alignment.

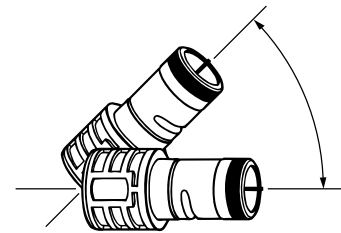

Nozzle can be mounted between 0° and 45°

## OPTIMUM SPRAY HEIGHT\*

HEIGHT	SPACING
100 cm	100 cm
150 cm	150 cm

\*When nozzle is mounted parallel to the ground.

## RECOMMENDED PRESSURE RANGE



## MATERIALS AVAILABLE

**VS** STAINLESS STEEL

## HOW TO ORDER

Stainless Steel with VisiFlo® color-coding

**Q C T F - V S 4 0**

Tip Type      Material Code      Capacity Size



# Quick Turbo FloodJet® WIDE ANGLE FLAT SPRAY

BROADCAST NOZZLES

TIP PART NO. (STRAINER MESH SIZE)	CAPACITY ONE TIP IN l/min	APPLICATION RATE FOR 100 cm SPRAY TIP SPACING											APPLICATION RATE FOR 150 cm SPRAY TIP SPACING										
		l/ha											l/ha										
		4 km/h	6 km/h	8 km/h	10 km/h	12 km/h	14 km/h	16 km/h	20 km/h	25 km/h	30 km/h	4 km/h	6 km/h	8 km/h	10 km/h	12 km/h	14 km/h	16 km/h	20 km/h	25 km/h	30 km/h		
QCTF-VS15	1.0	6.84	1026	684	513	410	342	293	257	205	164	137	684	456	342	274	228	195	171	137	109	91.2	
	1.5	8.38	1257	838	629	503	419	359	314	251	201	168	838	559	419	335	279	239	210	168	134	112	
	2.0	9.67	1451	967	725	580	484	414	363	290	232	193	967	645	484	387	322	276	242	193	155	129	
	3.0	11.85	1778	1185	889	711	593	508	444	356	284	237	1185	790	593	474	395	339	296	237	190	158	
QCTF-VS20	1.0	9.12	1368	912	684	547	456	391	342	274	219	182	912	608	456	365	304	261	228	182	146	122	
	1.5	11.17	1676	1117	838	670	559	479	419	335	268	223	1117	745	559	447	372	319	279	223	179	149	
	2.0	12.90	1935	1290	968	774	645	553	484	387	310	258	1290	860	645	516	430	369	323	258	206	172	
	3.0	15.80	2370	1580	1185	948	790	677	593	474	379	316	1580	1053	790	632	527	451	395	316	253	211	
QCTF-VS30	1.0	13.67	2051	1367	1025	820	684	586	513	410	328	273	1367	911	684	547	456	391	342	273	219	182	
	1.5	16.64	2511	1674	1256	1004	837	717	628	502	402	335	1674	1116	937	670	558	478	419	335	268	223	
	2.0	19.33	2900	1933	1450	1160	967	828	725	580	464	387	1933	1289	967	773	644	552	483	387	309	258	
	3.0	23.68	3552	2368	1776	1421	1184	1015	888	710	568	474	2368	1579	1184	947	789	677	592	474	379	316	
QCTF-VS40	1.0	18.23	2735	1823	1367	1094	912	781	684	547	438	365	1823	1215	912	729	608	521	456	365	292	243	
	1.5	22.33	3350	2233	1675	1340	1117	957	837	670	536	447	2233	1489	1117	893	744	638	558	447	357	298	
	2.0	25.78	3867	2578	1934	1547	1289	1105	967	773	619	516	2578	1719	1289	1031	859	737	645	516	412	344	
	3.0	31.58	4737	3158	2369	1895	1579	1353	1184	947	758	632	3158	2105	1579	1263	1053	902	790	632	505	421	
QCTF-VS50	1.0	22.79	3419	2279	1709	1367	1140	977	855	684	547	456	2279	1519	1140	912	760	651	570	456	365	304	
	1.5	27.91	4187	2791	2093	1675	1396	1196	1047	837	670	558	2791	1861	1396	1116	930	797	698	558	447	372	
	2.0	32.23	4835	3223	2417	1934	1612	1381	1209	967	774	645	3223	2149	1612	1289	1074	921	806	645	516	430	
	3.0	39.47	5921	3947	2960	2368	1974	1692	1480	1184	947	789	3947	2631	1974	1579	1316	1128	987	789	632	526	
QCTF-VS60	1.0	27.35	4103	2735	2051	1641	1368	1172	1026	821	656	547	2735	1823	1368	1094	912	781	684	547	438	365	
	1.5	33.50	5025	3350	2513	2010	1675	1436	1256	1005	804	670	3350	2233	1675	1340	1117	957	838	670	536	447	
	2.0	38.68	5802	3868	2901	2321	1934	1658	1451	1160	928	774	3868	2579	1934	1547	1289	1105	967	774	619	516	
	3.0	47.37	7106	4737	3553	2842	2369	2030	1776	1421	1137	947	4737	3158	2369	1895	1579	1353	1184	947	758	632	
QCTF-VS80	1.0	36.46	5469	3646	2735	2188	1823	1563	1367	1094	875	729	3646	2431	1823	1458	1215	1042	912	729	583	486	
	1.5	44.65	6698	4465	3349	2679	2233	1914	1674	1340	1072	893	4465	2977	2233	1786	1488	1276	1116	893	714	595	
	2.0	51.56	7734	5156	3867	3094	2578	2210	1934	1547	1237	1031	5156	3437	2578	2062	1719	1473	1289	1031	825	687	
	3.0	63.15	9473	6315	4736	3789	3158	2706	2368	1895	1516	1263	6315	4210	3158	2526	2105	1804	1579	1263	1010	842	
QCTF-VS100	1.0	45.58	6837	4558	3419	2735	2279	1953	1709	1367	1094	912	4558	3039	2279	1823	1519	1302	1140	912	729	608	
	1.5	55.82	8373	5582	4187	3349	2791	2392	2093	1675	1340	1116	5582	3721	2791	2233	1861	1595	1396	1116	893	744	
	2.0	64.46	9669	6446	4835	3868	3223	2763	2417	1934	1547	1289	6446	4297	3223	2578	2149	1842	1612	1289	1031	859	
	3.0	78.95	11843	7895	5921	4737	3948	3384	2961	2369	1895	1579	7895	5263	3948	3158	2632	2256	1974	1579	1263	1053	
QCTF-VS120	1.0	54.69	8204	5469	4102	3281	2735	2344	2051	1641	1313	1094	5469	3646	2735	2188	1823	1563	1367	1094	875	729	
	1.5	66.98	10047	6698	5024	4019	3349	2871	2512	2009	1608	1340	6698	4465	3349	2679	2233	1914	1675	1340	1072	893	
	2.0	77.34	11601	7734	5801	4640	3867	3315	2900	2320	1856	1547	7734	5156	3867	3094	2578	2210	1934	1547	1237	1031	
	3.0	94.73	14210	9473	7105	5684	4737	4060	3552	2842	2274	1895	9473	6315	4737	3789	3158	2707	2368	1895	1516	1263	

**Note:** Always double check your application rates. Tabulations are based on spraying water at 21°C. See technical information (pages 179–202) for useful formulas and other technical information.

# FloodJet® WIDE ANGLE FLAT SPRAY

BROADCAST NOZZLES

## RECOMMENDED PRESSURE RANGE



1-3 bar

## MATERIALS AVAILABLE



VS STAINLESS STEEL



SS STAINLESS STEEL



VP POLYMER



B BRASS



TK-VP FloodJet



TK-VS FloodJet



(B)1/4K FloodJet  
(1/2" - 1" NPT)



QCK  
Quick FloodJet

TIP PART NO. (STRAINER MESH SIZE)	bar	CAPACITY ONE TIP IN l/min	APPLICATION RATE FOR 100 cm SPRAY TIP SPACING							
			4 km/h	6 km/h	8 km/h	10 km/h	12 km/h	16 km/h	20 km/h	25 km/h
1/8K-.50 TK-.50 (100)	1.0	0.23	34.5	23.0	17.3	13.8	11.5	8.6	6.9	5.5
	1.5	0.28	42.0	28.0	21.0	16.8	14.0	10.5	8.4	6.7
	2.0	0.33	49.5	33.0	24.8	19.8	16.5	12.4	9.9	7.9
	3.0	0.40	60.0	40.0	30.0	24.0	20.0	15.0	12.0	9.6
1/8K-.75 TK-.75 (100)	1.0	0.34	51.0	34.0	25.5	20.4	17.0	12.8	10.2	8.2
	1.5	0.42	63.0	42.0	31.5	25.2	21.0	15.8	12.6	10.1
	2.0	0.48	72.0	48.0	36.0	28.8	24.0	18.0	14.4	11.5
	3.0	0.59	88.5	59.0	44.3	35.4	29.5	22.1	17.7	14.2
1/8K-1 TK-1 (100)	1.0	0.46	69.0	46.0	34.5	27.6	23.0	17.3	13.8	11.0
	1.5	0.56	84.0	56.0	42.0	33.6	28.0	21.0	16.8	13.4
	2.0	0.65	97.5	65.0	48.8	39.0	32.5	24.4	19.5	15.6
	3.0	0.80	120	80.0	60.0	48.0	40.0	30.0	24.0	19.2
1/8K-1.5 TK-1.5 (50)	1.0	0.68	102	68.0	51.0	40.8	34.0	25.5	20.4	16.3
	1.5	0.83	125	83.0	62.3	49.8	41.5	31.1	24.9	19.9
	2.0	0.96	144	96.0	72.0	57.6	48.0	36.0	28.8	23.0
	3.0	1.18	177	118	88.5	70.8	59.0	44.3	35.4	28.3
[1/8K, 1/4K, TK]-2 TK-2 (50)	1.0	0.91	137	91.0	68.3	54.6	45.5	34.1	27.3	21.8
	1.5	1.11	167	111	83.3	66.6	55.5	41.6	33.3	26.6
	2.0	1.29	194	129	96.8	77.4	64.5	48.4	38.7	31.0
	3.0	1.58	237	158	119	94.8	79.0	59.3	47.4	37.9
[1/8K, 1/4K, TK]-2.5 TK-2.5 (50)	1.0	1.14	171	114	85.5	68.4	57.0	42.8	34.2	27.4
	1.5	1.40	210	140	105	84.0	70.0	52.5	42.0	33.6
	2.0	1.61	242	161	121	96.6	80.5	60.4	48.3	38.6
	3.0	1.97	296	197	148	118	98.5	73.9	59.1	47.3
[1/8K, 1/4K, TK]-3 [TK]-3 (50)	1.0	1.37	206	137	103	82.2	68.5	51.4	41.1	32.9
	1.5	1.68	252	168	126	101	84.0	63.0	50.4	40.3
	2.0	1.94	291	194	146	116	97.0	72.8	58.2	46.6
	3.0	2.37	356	237	178	142	119	88.9	71.1	56.9
[1/8K, TK]-4 (50) TK-4 (50)	1.0	1.82	273	182	137	109	91.0	68.3	54.6	43.7
	1.5	2.23	335	223	167	134	112	83.6	66.9	53.5
	2.0	2.57	386	257	193	154	129	96.4	77.1	61.7
	3.0	3.15	473	315	236	189	158	118	94.5	75.6
[1/8K, 1/4K, TK]-5 [TK]-5 (50)	1.0	2.28	342	228	171	137	114	85.5	68.4	54.7
	1.5	2.79	419	279	209	167	140	105	83.7	67.0
	2.0	3.22	483	322	242	193	161	121	96.6	77.3
	3.0	3.95	593	395	296	237	198	148	119	94.8
[1/8K, 1/4K, TK]-7.5 TK-7.5 (50)	1.0	3.42	513	342	257	205	171	128	103	82.1
	1.5	4.19	629	419	314	251	210	157	126	101
	2.0	4.84	726	484	363	290	242	182	145	116
	3.0	5.92	888	592	444	355	296	222	178	142
[1/8K, 1/4K, TK]-10 TK-10 (50)	1.0	4.56	684	456	342	274	228	171	137	109
	1.5	5.58	837	558	419	335	279	209	167	134
	2.0	6.45	968	645	484	387	323	242	194	155
	3.0	7.90	1185	790	593	474	395	296	237	190
[1/8K, 1/4K]-12 TK-12	1.0	5.47	821	547	410	328	274	205	164	131
	1.5	6.70	1005	670	503	402	335	251	201	161
	2.0	7.74	1161	774	581	464	387	290	232	186
	3.0	9.47	1421	947	710	568	474	355	284	227
[1/8K, 1/4K]-15 TK-15	1.0	6.84	1026	684	513	410	342	257	205	164
	1.5	8.38	1257	838	629	503	419	314	251	201
	2.0	9.67	1451	967	725	580	484	363	290	232
	3.0	11.8	1770	1180	885	708	590	443	354	283
[1/8K, 1/4K]-18 TK-18	1.0	8.20	1230	820	615	492	410	308	246	197
	1.5	10.0	1500	1000	750	600	500	375	300	240
	2.0	11.6	1740	1160	870	696	580	435	348	278
	3.0	14.2	2130	1420	1065	852	710	533	426	341
[1/8K, 1/4K]-20 TK-20 QCK-20	1.0	9.12	1368	912	684	547	456	342	274	219
	1.5	11.2	1680	1120	840	672	560	420	336	269
	2.0	12.9	1935	1290	968	774	645	484	387	310
	3.0	15.8	2370	1580	1185	948	790	593	474	379
1/4K-22	1.0	10.0	1500	1000	750	600	500	375	300	240
	1.5	12.2	1830	1220	915	732	610	458	366	293
	2.0	14.1	2115	1410	1058	846	705	529	423	338
	3.0	17.3	2595	1730	1298	1038	865	649	519	415
1/4K-24	1.0	10.9	1635	1090	818	654	545	409	327	262
	1.5	13.3	1995	1330	998	798	665	499	399	319
	2.0	15.4	2310	1540	1155	924	770	578	462	370
	3.0	18.9	2835	1890	1418	1134	945	709	567	454

**Note:** Always double check your application rates. Tabulations are based on spraying water at 21°C. See technical information (pages 179-202) for useful formulas and other technical information. Other spray angles, capacities, and materials may be available. See your TeeJet Dealer or [www.teejet.com](http://www.teejet.com) for more information. (B) = BSPT Thread

## HOW TO ORDER

Stainless Steel with VisiFlo® color-coding

Q C K - S S 1 0 0

Tip Type

Material Code

Capacity Size

T K - V S 5

Tip Type

Material Code

Capacity Size

Polymer with VisiFlo color-coding

T K - V P 3

Tip Type

Material Code

Capacity Size

Brass

( B ) 1 / 4 K - 5

BSPT Thread

Tip Type

Capacity Size

Stainless Steel

( B ) 1 / 8 K - S S 5

BSPT Thread

Tip Type

Material Code

Capacity Size

TIP PART NO.	bar	CAPACITY ONE TIP IN l/min	APPLICATION RATE FOR 150 cm SPRAY TIP SPACING							
			4 km/h	6 km/h	8 km/h	10 km/h	12 km/h	16 km/h	20 km/h	25 km/h
1/4K-27	1.0	12.3	1230	820	615	492	410	308	246	197
	1.5	15.1	1510	1007	755	604	503	378	302	242
	2.0	17.4	1740	1160	870	696	580	435	348	278
	3.0	21.3	2130	1420	1065	852	710	533	426	341
3/8K-30 TK-30	1.0	13.7	1370	913	685	548	457	343	274	219
	1.5	16.8	1680	1120	840	672	560	420	336	269
QCK-30	2.0	19.4	1940	1293	970	776	647	485	388	310
	3.0	23.7	2370	1580	1185	948	790	593	474	379
3/8K-35	1.0	16.0	1600	1067	800	640	533	400	320	256
	1.5	19.6	1960	1307	980	784	653	490	392	314
	2.0	22.6	2260	1507	1130	904	753	565	452	362
	3.0	27.7	2770	1847	1385	1108	923	693	554	443
[3/8K, 1/2K]-40	1.0	18.2	1820	1213	910	728	607	455	364	291
	1.5	22.3	2230	1487	1115	892	743	558	446	357
QCK-40	2.0	25.7	2570	1713	1285	1028	857	643	514	411
	3.0	31.5	3150	2100	1575	1260	1050	788	630	504
	1.0	20.5	2050	1367	1025	820	683	513	410	328
3/8K-45	1.5	25.1	2510	1673	1255	1004	837	628	502	402
	2.0	29.0	2900	1933	1450	1160	967	725	580	464
	3.0	35.5	3550	2367	1775	1420	1183	888	710	568
1/2K-50	1.0	22.8	2280	1520	1140	912	760	570	456	365
	1.5	27.9	2790	1860	1395	1116	930	698	558	446
QCK-50	2.0	32.2	3220	2147	1610	1288	1073	805	644	515
	3.0	39.5	3950	2633	1975	1580	1317	988	790	632
1/2K-60	1.0	27.3	2730	1820	1365	1092	910	683	546	437
	1.5	33.4	3340	2227	1670	1336	1113	835	668	534
QCK-60	2.0	38.6	3860	2573	1930	1544	1287	965	772	618
	3.0	47.3	4730	3153	2365	1892	1577	1183	946	757
	1.0	31.9	3190	2127	1595	1276	1063	798	638	510
1/2K-70	1.5	39.1	3910	2607	1955	1564	1303	978	782	626
	2.0	45.1	4510	3007	2255	1804	1503	1128	902	722
	3.0	55.3	5530	3687	2765	2212	1843	1383	1106	885
	1.0	36.5	3650	2433	1825	1460	1217	913	730	584
[1/2K, 3/4K]-80	1.5	44.7	4470	2980	2235	1788	1490	1118	894	715
	2.0	51.6	5160	3440	2580	2064	1720	1290	1032	826
	3.0	63.2	6320	4213	3160	2528	2107	1580	1264	1011
[1/2K, 3/4K]-90	1.0	41.0	4100	2733	2050	1640	1367	1025	820	656
	1.5	50.2	5020	3347	2510	2008	1673	1255	1004	803
	2.0	58.0	5800	3867	2900	2320	1933	1450	1160	928
	3.0	71.0	7100	4733	3550	2840	2367	1775	1420	1136
3/4K-100	1.0	45.6	4560	3040	2280	1824	1520	1140	912	730
	1.5	55.8	5580	3720	2790	2232	1860	1395	1116	893
QCK-100	2.0	64.5	6450	4300	3225	2580	2150	1613	1290	1032
	3.0	79.0	7900	5267	3950	3160	2633	1975	1580	1264
	1.0	50.1	5010	3340	2505	2004	1670	1253	1002	802
3/4K-110	1.5	61.4	6140	4093	3070	2456	2047	1535	1228	982
	2.0	70.9	7090	4727	3545	2836	2363	1773	1418	1134
	3.0	86.8	8680	5787	4340	3472	2893	2170	1736	1389
	1.0	54.7	5470	3647	2735	2188	1823	1368	1094	875
[1/2K, 3/4K]-120	1.5	67.0	6700	4467	3350	2680	2233	1675	1340	1072
	2.0	77.4	7740	5160	3870	3096	2580	1935	1548	1238
	3.0	94.7	9470	6313	4735	3788	3157	2368	1894	1515
3/4K-140	1.0	63.8	6380	4253	3190	2552	2127	1595	1276	1021
	1.5	78.1	7810	5207	3905	3124	2603	1953	1562	1250
	2.0	90.2	9020	6013	4510	3608	3007	2255	1804	1443
	3.0	111	11100	7400	5550	4440	3700	2775	2220	1776
QCK-150	1.0	68.4	6840	4560	3420	2736	2280	1710	1368	1094
	1.5	83.8	8380	5587	4190	3352	2793	2095	1676	1341
	2.0	96.7	9670	6447	4835	3868	3223	2418	1934	1547
	3.0	118	11800	7867	5900	4720	3933	2950	2360	1888
3/4K-160	1.0	72.9	7290	4860	3645	2916	2430	1823	1458	1166
	1.5	89.3	8930	5953	4465	3572	2977	2233	1786	1429
	2.0	103	10300	6867	5150	4120	3433	2575	2060	1648
	3.0	126	12600	8400	6300	5040	4200	3150	2520	2016
3/4K-180	1.0	82.0	8200	5467	4100	3280	2733	2050	1640	1312
	1.5	100	10000	6667	5000	4000	3333	2500	2000	1600
QCK-180	2.0	116	11600	7733	5800	4640	3867	2900	2320	1856
	3.0	142	14200	9467	7100	5680	4733	3550	2840	2272
	1.0	95.7	9570	6380	4785	3828	3190	2393	1914	1531
3/4K-210	1.5	117	11700	7800	5850	4680	3900	2925	2340	1872
	2.0	135	13500	9000	6750	5400	4500	3375	2700	2160
QCK-210	3.0	166	16600	11067	8300	6640	5533	4150	3320	2656

**Note:** Always double check your application rates. Tabulations are based on spraying water at 21°C. See technical information (pages 179–202) for useful formulas and other technical information. Other spray angles, capacities, and materials may be available. See your TeeJet Dealer or [www.teejet.com](http://www.teejet.com) for more information.



## Typical Applications



**HERBICIDE**  
SOIL APPLIED  
**EXCELLENT**  
SYSTEMIC  
**EXCELLENT**



**FERTILIZER**  
BROADCAST  
**EXCELLENT**



**DRIFT CONTROL**  
**EXCELLENT**



### FEATURES

- Very large droplets.
- More precise flow and distribution pattern.
- Large orifice reduces clogging.
- 1/4TTJ(VS) is available in seven VisiFlo® capacities (02 to 15) and 1/4TTJ(VP) is available in four VisiFlo capacities (06 to 15).

### QJ4676-90-1/4-NYR

- 90° fitting attaches to Quick TeeJet bodies—1/4" female threaded outlet.
- Simple installation of TurfJet nozzles on vertical nozzle bodies.
- Nylon construction.



### SPRAY PATTERN

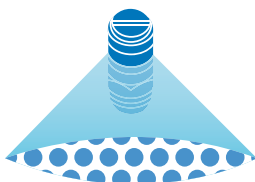

### DROPLET SIZE CLASSIFICATION

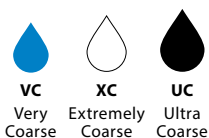

### OPTIMUM SPRAY HEIGHT

HEIGHT	SPACING
60 cm*	50 cm
75 cm*	75 cm
100 cm*	100 cm

\*Wide angle spray nozzle height is influenced by nozzle orientation. The critical factor is to achieve a minimum 30% overlap.

### RECOMMENDED PRESSURE RANGE



### MATERIALS AVAILABLE

**VP** POLYMER

**VS** STAINLESS STEEL

### HOW TO ORDER

Stainless Steel with VisiFlo color-coding

1 / 4 T T J 0 4 - V S

Tip Type

Capacity Size

Material Code

Polymer with VisiFlo color-coding

1 / 4 T T J 0 6 - V P

Tip Type

Capacity Size

Material Code

TIP PART NO. (STRAINER MESH SIZE)	bar	DROP SIZE	CAPACITY ONE NOZZLE IN l/min	APPLICATION RATE FOR 100 cm SPRAY TIP SPACING												
				l/ha												
				4 km/h	5 km/h	6 km/h	7 km/h	8 km/h	9 km/h	10 km/h	12 km/h	16 km/h	20 km/h	25 km/h	30 km/h	35 km/h
1/4TTJ02 (50)	1.5	UC	0.56	84.0	67.2	56.0	48.0	42.0	37.3	33.6	28.0	21.0	16.8	13.4	11.2	9.6
	2.0	XC	0.65	97.5	78.0	65.0	55.7	48.8	43.3	39.0	32.5	24.4	19.5	15.6	13.0	11.1
	3.0	XC	0.79	119	94.8	79.0	67.7	59.3	52.7	47.4	39.5	29.6	23.7	19.0	15.8	13.5
	4.0	VC	0.91	137	109	91.0	78.0	68.3	60.7	54.6	45.5	34.1	27.3	21.8	18.2	15.6
	5.0	VC	1.02	153	122	102	87.4	76.5	68.0	61.2	51.0	38.3	30.6	24.5	20.4	17.5
1/4TTJ04 (50)	1.5	UC	1.12	168	134	112	96.0	84.0	74.7	67.2	56.0	42.0	33.6	26.9	22.4	19.2
	2.0	UC	1.29	194	155	129	111	96.8	86.0	77.4	64.5	48.4	38.7	31.0	25.8	22.1
	3.0	UC	1.58	237	190	158	135	119	105	94.8	79.0	59.3	47.4	37.9	31.6	27.1
	4.0	UC	1.82	273	218	182	156	137	121	109	91.0	68.3	54.6	43.7	36.4	31.2
	5.0	UC	2.04	306	245	204	175	153	136	122	102	76.5	61.2	49.0	40.8	35.0
1/4TTJ05 (50)	1.5	UC	1.39	209	167	139	119	104	92.7	83.4	69.5	52.1	41.7	33.4	27.8	23.8
	2.0	UC	1.61	242	193	161	138	121	107	96.6	80.5	60.4	48.3	38.6	32.2	27.6
	3.0	UC	1.97	296	236	197	169	148	131	118	98.5	73.9	59.1	47.3	39.4	33.8
	4.0	UC	2.27	341	272	227	195	170	151	136	114	85.1	68.1	54.5	45.4	38.9
	5.0	UC	2.54	381	305	254	218	191	169	152	127	95.3	76.2	61.0	50.8	43.5
1/4TTJ06 (50)	1.5	UC	1.68	252	202	168	144	126	112	101	84.0	63.0	50.4	40.3	33.6	28.8
	2.0	UC	1.94	291	233	194	166	146	129	116	97.0	72.8	58.2	46.6	38.8	33.3
	3.0	UC	2.37	356	284	237	203	178	158	142	119	88.9	71.1	56.9	47.4	40.6
	4.0	UC	2.74	411	329	274	235	206	183	164	137	103	82.2	65.8	54.8	47.0
	5.0	UC	3.06	459	367	306	262	230	204	184	153	115	91.8	73.4	61.2	52.5
1/4TTJ08	1.5	UC	2.23	335	268	223	191	167	149	134	112	83.6	66.9	53.5	44.6	38.2
	2.0	UC	2.58	387	310	258	221	194	172	155	129	96.8	77.4	61.9	51.6	44.2
	3.0	UC	3.16	474	379	316	271	237	211	190	158	119	94.8	75.8	63.2	54.2
	4.0	UC	3.65	548	438	365	313	274	243	219	183	137	110	87.6	73.0	62.6
	5.0	UC	4.08	612	490	408	350	306	272	245	204	153	122	97.9	81.6	69.9
1/4TTJ10	1.5	UC	2.79	419	335	279	239	209	186	167	140	105	83.7	67.0	55.8	47.8
	2.0	UC	3.23	485	388	323	277	242	215	194	162	121	96.9	77.5	64.6	55.4
	3.0	UC	3.95	593	474	395	339	296	263	237	198	148	119	94.8	79.0	67.7
	4.0	UC	4.56	684	547	456	391	342	304	274	228	171	137	109	91.2	78.2
	5.0	UC	5.10	765	612	510	437	383	340	306	255	191	153	122	102	87.4
1/4TTJ15	1.5	UC	4.19	629	503	419	359	314	279	251	210	157	126	101	83.8	71.8
	2.0	UC	4.83	725	580	483	414	362	322	290	242	181	145	116	96.6	82.8
	3.0	UC	5.92	888	710	592	507	444	395	355	296	222	178	142	118	101
	4.0	UC	6.84	1026	821	684	586	513	456	410	342	257	205	164	137	117
	5.0	UC	7.64	1146	917	764	655	573	509	458	382	287	229	183	153	131

**Note:** Always double check your application rates. Droplet size classification shown is based on ISO 25358. Droplet size classification standard is subject to change. Tabulations are based on spraying water at 21°C. See technical information (pages 179–202) for droplet size classification, useful formulas and other technical information.

## Typical Applications



**HERBICIDE**  
SOIL APPLIED  
**EXCELLENT**  
SYSTEMIC  
**EXCELLENT**



**FUNGICIDE**  
SYSTEMIC  
**EXCELLENT**



**INSECTICIDE**  
SYSTEMIC  
**EXCELLENT**



**FERTILIZER**  
BROADCAST  
**EXCELLENT**



**DRIFT CONTROL**  
**VERY GOOD**



## FEATURES

- Large droplets to reduce drift.
- Wide spray angle up to 120° allows use on 100 cm spacing.
- Can be used with 114445A\*-CELRL for Quick TeeJet® connection. Reference page 118 for more information.

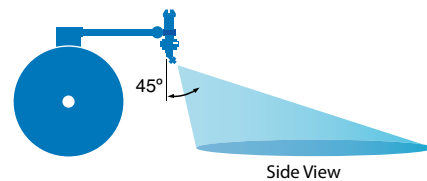

## SPRAY PATTERN

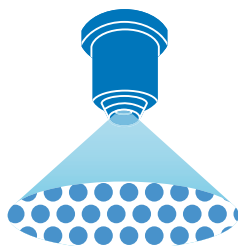

## OPTIMUM SPRAY HEIGHT

HEIGHT	SPACING
50 cm*	50 cm
75 cm*	75 cm
100 cm*	100 cm

FullJet nozzles should be angled 30°–45° from vertical for uniform spray distribution.

\*Wide angle spray nozzle height is influenced by nozzle orientation. The critical factor is to achieve a minimum 30% overlap.

## RECOMMENDED PRESSURE RANGE



1–3 bar

## MATERIALS AVAILABLE

**VS** STAINLESS STEEL

## HOW TO ORDER

Stainless Steel with VisiFlo® color-coding

**F L - 5 V S**

Tip Capacity Material  
Type Size Code

Celcon with Stainless Steel vane and VisiFlo color-coding

**F L - 5 V C**

Tip Capacity Material  
Type Size Code

TIP PART NO. (STRAINER MESH SIZE)	 bar	CAPACITY ONE TIP IN l/min	APPLICATION RATE FOR 50 cm SPRAY TIP SPACING						APPLICATION RATE FOR 100 cm SPRAY TIP SPACING					
			l/ha						l/ha					
			4 km/h	6 km/h	8 km/h	10 km/h	15 km/h	20 km/h	4 km/h	6 km/h	8 km/h	10 km/h	15 km/h	20 km/h
FL-5	1.0	1.19	357	238	179	143	95	71	179	119	89	71	48	36
	1.5	1.43	429	286	215	172	114	86	215	143	107	86	57	43
	2.0	1.69	507	338	254	203	135	101	254	169	127	101	68	51
	2.5	1.81	543	362	272	217	145	109	272	181	136	109	72	54
	3.0	1.97	591	394	296	236	158	118	296	197	148	118	79	59
FL-6.5	1.0	1.56	468	312	234	187	125	94	234	156	117	94	62	47
	1.5	1.89	567	378	284	227	151	113	284	189	142	113	76	57
	2.0	2.14	642	428	321	257	171	128	321	214	161	128	86	64
	2.5	2.34	702	468	351	281	187	140	351	234	176	140	94	70
	3.0	2.56	768	512	384	307	205	154	384	256	192	154	102	77
FL-8	1.0	1.90	570	380	285	228	152	114	285	190	143	114	76	57
	1.5	2.29	687	458	344	275	183	137	344	229	172	137	92	69
	2.0	2.60	780	520	390	312	208	156	390	260	195	156	104	78
	2.5	2.89	867	578	434	347	231	173	434	289	217	173	116	87
	3.0	3.15	945	630	473	378	252	189	473	315	236	189	126	95
FL-10	1.0	2.37	711	474	356	284	190	142	356	237	178	142	95	71
	1.5	2.86	858	572	429	343	229	172	429	286	215	172	114	86
	2.0	3.39	1017	678	509	407	271	203	509	339	254	203	136	102
	2.5	3.62	1086	724	543	434	290	217	543	362	272	217	145	109
	3.0	3.93	1179	786	590	472	314	236	590	393	295	236	157	118
FL-15	1.0	3.56	1068	712	534	427	285	214	534	356	267	214	142	107
	1.5	4.29	1287	858	644	515	343	257	644	429	322	257	172	129
	2.0	4.84	1452	968	726	581	387	290	726	484	363	290	194	145
	2.5	5.43	1629	1086	815	652	434	326	815	543	407	326	217	163
	3.0	5.90	1770	1180	885	708	472	354	885	590	443	354	236	177

**Note:** Always double check your application rates. Tabulations are based on spraying water at 21°C. See technical information (pages 179–202) for useful formulas and other technical information.





## 150° SERIES STAINLESS STEEL AND BRASS

Suggested for post-directed application with hose drops.

### SPRAY PATTERN

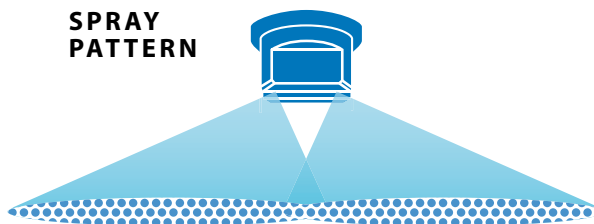

TIP PART NO. (STRAINER MESH SIZE)	bar	CAPACITY ONE TIP IN l/min	APPLICATION RATE FOR 50 cm SPRAY TIP SPACING							
			l/ha							
			4 km/h	6 km/h	8 km/h	10 km/h	12 km/h	14 km/h	16 km/h	18 km/h
TQ150-01-SS (100)	1.5	0.28	84.0	56.0	42.0	33.6	28.0	24.0	21.0	18.7
	2.0	0.32	96.0	64.0	48.0	38.4	32.0	27.4	24.0	21.3
	2.5	0.36	108	72.0	54.0	43.2	36.0	30.9	27.0	24.0
	3.0	0.39	117	78.0	58.5	46.8	39.0	33.4	29.3	26.0
	3.5	0.42	126	84.0	63.0	50.4	42.0	36.0	31.5	28.0
TQ150-015-SS (100)	1.5	0.42	126	84.0	63.0	50.4	42.0	36.0	31.5	28.0
	2.0	0.48	144	96.0	72.0	57.6	48.0	41.1	36.0	32.0
	2.5	0.54	162	108	81.0	64.8	54.0	46.3	40.5	36.0
	3.0	0.59	177	118	88.5	70.8	59.0	50.6	44.3	39.3
	3.5	0.64	192	128	96.0	76.8	64.0	54.9	48.0	42.7
TQ150-02-SS (100)	1.5	0.56	168	112	84.0	67.2	56.0	48.0	42.0	37.3
	2.0	0.65	195	130	97.5	78.0	65.0	55.7	48.8	43.3
	2.5	0.72	216	144	108	86.4	72.0	61.7	54.0	48.0
	3.0	0.79	237	158	119	94.8	79.0	67.7	59.3	52.7
	3.5	0.85	255	170	128	102	85.0	72.9	63.8	56.7
TQ150-03-SS (100)	1.5	0.83	249	166	125	99.6	83.0	71.1	62.3	55.3
	2.0	0.96	288	192	144	115	96.0	82.3	72.0	64.0
	2.5	1.08	324	216	162	130	108	92.6	81.0	72.0
	3.0	1.18	354	236	177	142	118	101	88.5	78.7
	3.5	1.27	381	254	191	152	127	109	95.3	84.7
TQ150-04-SS (50)	1.5	1.12	336	224	168	134	112	96.0	84.0	74.7
	2.0	1.29	387	258	194	155	129	111	96.8	86.0
	2.5	1.44	432	288	216	173	144	123	108	96.0
	3.0	1.58	474	316	237	190	158	135	119	105
	3.5	1.71	513	342	257	205	171	147	128	114
TQ150-05-SS (50)	1.5	1.39	417	278	209	167	139	119	104	92.7
	2.0	1.61	483	322	242	193	161	138	121	107
	2.5	1.80	540	360	270	216	180	154	135	120
	3.0	1.97	591	394	296	236	197	169	148	131
	3.5	2.13	639	426	320	256	213	183	160	142
TQ150-06-SS (50)	1.5	1.68	504	336	252	202	168	144	126	112
	2.0	1.94	582	388	291	233	194	166	146	129
	2.5	2.16	648	432	324	259	216	185	162	144
	3.0	2.37	711	474	356	284	237	203	178	158
	3.5	2.56	768	512	384	307	256	219	192	171
TQ150-08-SS (50)	1.5	2.23	669	446	335	268	223	191	167	149
	2.0	2.58	774	516	387	310	258	221	194	172
	2.5	2.88	864	576	432	346	288	247	216	192
	3.0	3.16	948	632	474	379	316	271	237	211
	3.5	3.41	1023	682	512	409	341	292	256	227
TQ150-09-SS (50)	1.5	2.51	753	502	377	301	251	215	188	167
	2.0	2.90	870	580	435	348	290	249	218	193
	2.5	3.24	972	648	486	389	324	278	243	216
	3.0	3.55	1065	710	533	426	355	304	266	237
	3.5	3.83	1149	766	575	460	383	328	287	255

**Note:** Always double check your application rates. Tabulations are based on spraying water at 21°C. See technical information (pages 179–202) for useful formulas and other technical information.

### RECOMMENDED PRESSURE RANGE



1.5–3.5 bar

### MATERIALS AVAILABLE

**SS** STAINLESS STEEL

**B** BRASS

### HOW TO ORDER

Stainless Steel  
**T Q 1 5 0 - 0 3 - S S**  
 Tip Type      Capacity Size      Material Code

Brass  
**T Q 1 5 0 - 0 1**  
 Tip Type      Capacity Size

TeeJet Off-Center spray tips are commonly installed in double and single swivel nozzle bodies. Because these bodies are adjustable for angular position, a wide spray swath is easily obtained.

See page 140 for swivels and hose drops.

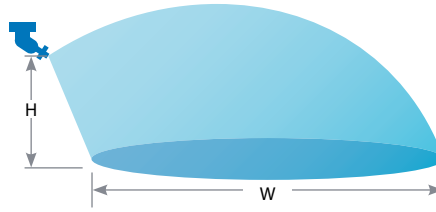

TIP PART NO. (STRAINER MESH SIZE)	bar	CAPACITY ONE TIP IN l/min	HEIGHT = 45 cm				HEIGHT = 60 cm					
			"W" cm	l/ha				"W" cm	l/ha			
				4 km/h	6 km/h	8 km/h	10 km/h		4 km/h	6 km/h	8 km/h	10 km/h
OC-01 (100)	2.0	0.32	147	32.7	21.8	16.3	13.1	165	29.1	19.4	14.5	11.6
	3.0	0.39	152	38.5	25.7	19.2	15.4	170	34.4	22.9	17.2	13.8
	4.0	0.45	157	43.0	28.7	21.5	17.2	175	38.6	25.7	19.3	15.4
OC-02 (50)	2.0	0.65	172	56.7	37.8	28.3	22.7	190	51.3	34.2	25.7	20.5
	3.0	0.79	177	66.9	44.6	33.5	26.8	195	60.8	40.5	30.4	24.3
	4.0	0.91	182	75.0	50.0	37.5	30.0	198	68.9	46.0	34.5	27.6
OC-03 (50)	2.0	0.96	195	73.8	49.2	36.9	29.5	203	70.9	47.3	35.5	28.4
	3.0	1.18	203	87.2	58.1	43.6	34.9	210	84.3	56.2	42.1	33.7
	4.0	1.36	208	98.1	65.4	49.0	39.2	215	94.9	63.3	47.4	38.0
OC-04 (50)	2.0	1.29	231	83.8	55.8	41.9	33.5	236	82.0	54.7	41.0	32.8
	3.0	1.58	236	100	66.9	50.2	40.2	238	99.6	66.4	49.8	39.8
	4.0	1.82	238	115	76.5	57.4	45.9	241	113	75.5	56.6	45.3
OC-06 (50)	2.0	1.94	251	116	77.3	58.0	46.4	274	106	70.8	53.1	42.5
	3.0	2.37	256	139	92.6	69.4	55.5	279	127	84.9	63.7	51.0
	4.0	2.74	259	159	106	79.3	63.5	281	146	97.5	73.1	58.5
OC-08 (50)	2.0	2.58	254	152	102	76.2	60.9	279	139	92.5	69.4	55.5
	3.0	3.16	259	183	122	91.5	73.2	284	167	111	83.5	66.8
	4.0	3.65	264	207	138	104	83.0	287	191	127	95.4	76.3
OC-12	2.0	3.87	259	224	149	112	89.7	287	202	135	101	80.9
	3.0	4.74	264	269	180	135	108	292	243	162	122	97.4
	4.0	5.47	266	308	206	154	123	294	279	186	140	112
OC-16	2.0	5.16	335	231	154	116	92.4	360	215	143	108	86.0
	3.0	6.32	350	271	181	135	108	370	256	171	128	102
	4.0	7.30	363	302	201	151	121	375	292	195	146	117

**Note:** Always double check your application rates. Tabulations are based on spraying water at 21°C. See technical information (pages 179–202) for useful formulas and other technical information.

## RECOMMENDED PRESSURE RANGE



2–4 bar

## MATERIALS AVAILABLE



STAINLESS STEEL



BRASS

## HOW TO ORDER

Brass

OC - 0 2

Tip Type

Capacity Size

Stainless Steel

OC - S S 0 6

Tip Type

Material Code

Capacity Size

## Typical Applications



**HERBICIDE**  
SOIL APPLIED  
**EXCELLENT**  
SYSTEMIC  
**EXCELLENT**



**FERTILIZER**  
BROADCAST  
**EXCELLENT**



**DRIFT CONTROL**  
**EXCELLENT**



## FEATURES

- Unique orifice geometry produces a wide spray pattern while maintaining superior distribution across entire width.
- Pre-orifice design minimizes drift.
- Extra wide spray pattern—up to 5.5 meters—using a single nozzle.
- Removable polymer pre-orifice.
- NPT or BSPT (male) threads for easy installation.

**Mounting Note:** Position nozzle horizontal to ground with spray pattern down and to the side.

## SPRAY PATTERN

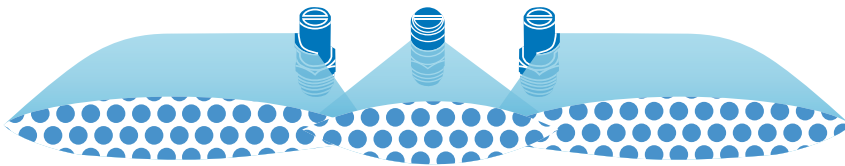

**Note:** The addition of the middle nozzle is one option of configuration. XP BoomJet can be used with TurfJet (1/4TTJ) found on pages 52–53.

## DROPLET SIZE CLASSIFICATION

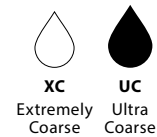

## RECOMMENDED PRESSURE RANGE



1.5–4 bar

## MATERIALS AVAILABLE



POLYMER

## HOW TO ORDER

Polymer with VisiFlo® color-coding

( B ) 1 / 2 X P 8 0 L ( R ) - V P

BSPT Thread	Tip Type	Capacity Size	Left or Right Boom Spray	Material Code
----------------	-------------	------------------	-----------------------------	------------------

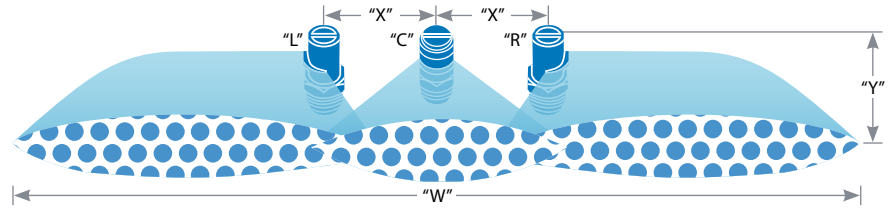

TIP PART NO. "R", "L"	CENTER NOZZLE "C"	bar	DROP SIZE	CAPACITY THREE NOZZLES IN l/min	SPRAY WIDTH "W" (METERS)		l/ha FOR THREE NOZZLES											
							"X" = APPLICATION RATE FOR 50 cm SPRAY NOZZLE SPACING											
					60 cm HEIGHT	90 cm HEIGHT	HEIGHT "Y" = 60 cm						HEIGHT "Y" = 90 cm					
							4 km/h	8 km/h	12 km/h	16 km/h	24 km/h	32 km/h	4 km/h	8 km/h	12 km/h	16 km/h	24 km/h	32 km/h
(B)1/4XP10R (B)1/4XP10L	1/4TTJ08	1.5	UC	7.85	6.2	7.0	190	95.0	63.3	47.5	31.7	23.7	168	84.1	56.1	42.1	28.0	21.0
		2.0	UC	9.04	7.0	7.8	194	96.9	64.6	48.4	32.3	24.2	174	86.9	57.9	43.5	29.0	21.7
		3.0	XC	11.1	7.8	8.6	213	107	71.2	53.4	35.6	26.7	194	96.8	64.5	48.4	32.3	24.2
		3.5	XC	11.9	8.6	9.2	208	104	69.2	51.9	34.6	25.9	194	97.0	64.7	48.5	32.3	24.3
(B)1/4XP20R (B)1/4XP20L	1/4TTJ08	1.5	UC	13.4	6.4	7.8	314	157	105	78.5	52.3	39.3	258	129	85.9	64.4	42.9	32.2
		2.0	UC	15.4	8.0	8.4	289	144	96.3	72.2	48.1	36.1	275	138	91.7	68.8	45.8	34.4
		3.0	XC	18.9	9.2	9.6	308	154	103	77.0	51.4	38.5	295	148	98.4	73.8	49.2	36.9
		3.5	XC	20.5	9.8	10.2	314	157	105	78.4	52.3	39.2	301	151	100	75.4	50.2	37.7
(B)1/4XP25R (B)1/4XP25L	1/4TTJ10	1.5	UC	16.5	7.4	7.8	334	167	111	83.6	55.7	41.8	317	159	106	79.3	52.9	39.7
		2.0	UC	19.1	8.4	9.2	341	171	114	85.3	56.8	42.6	311	156	104	77.9	51.9	38.9
		3.0	UC	23.5	9.2	9.8	383	192	128	95.8	63.9	47.9	360	180	120	89.9	59.9	45.0
		3.5	XC	25.3	9.8	10.2	387	194	129	96.8	64.5	48.4	372	186	124	93.0	62.0	46.5
(B)1/2XP40R (B)1/2XP40L	1/4TTJ15	1.5	UC	26.6	7.8	8.4	512	256	171	128	85.3	63.9	475	238	158	119	79.2	59.4
		2.0	UC	31.0	9.0	9.8	517	258	172	129	86.1	64.6	474	237	158	119	79.1	59.3
		3.0	UC	37.7	9.6	10.4	589	295	196	147	98.2	73.6	544	272	181	136	90.6	68.0
		3.5	UC	40.4	10.2	10.8	594	297	198	149	99.0	74.3	561	281	187	140	93.5	70.1
4.0	UC	43.6	10.8	11.6	606	303	202	151	101	75.7	564	282	188	141	94.0	70.5		

**Note:** Always double check your application rates. Droplet size classification shown is based on ISO 25358. Droplet size classification standard is subject to change. Tabulations are based on spraying water at 21°C. See technical information (pages 179-202) for droplet size classification, useful formulas and other technical information. When XP BoomJet is combined with 1/4TTJ nozzle the minimum pressure used must be 2 bar.

(B)=BSPT

For lower chart only, application rates are identical for a two-tip setup. Swath width and flow capacity will be doubled for a two-tip setup.

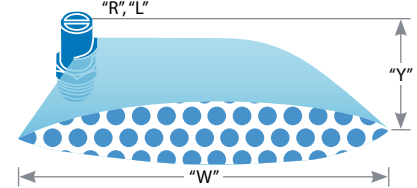

TIP PART NO.	bar	DROP SIZE	CAPACITY ONE NOZZLE IN l/min		SPRAY WIDTH "W" (METERS)		l/ha FOR ONE NOZZLE																		
							HEIGHT "Y" = 60 cm									HEIGHT "Y" = 90 cm									
			60 cm HEIGHT	90 cm HEIGHT	4 km/h	6 km/h	8 km/h	10 km/h	12 km/h	16 km/h	20 km/h	25 km/h	30 km/h	35 km/h	4 km/h	6 km/h	8 km/h	10 km/h	12 km/h	16 km/h	20 km/h	25 km/h	30 km/h	35 km/h	
(B)1/4XP10R (B)1/4XP10L	1.5	UC	2.81	2.6	3.0	162	108	81.1	64.8	54.0	40.5	32.4	25.9	21.6	18.5	141	93.7	70.3	56.2	46.8	35.1	28.1	22.5	18.7	16.1
	2.0	UC	3.23	3.0	3.4	162	108	80.8	64.6	53.8	40.4	32.3	25.8	21.5	18.5	143	95.0	71.3	57.0	47.5	35.6	28.5	22.8	19.0	16.3
	3.0	XC	3.95	3.4	3.8	174	116	87.1	69.7	58.1	43.6	34.9	27.9	23.2	19.9	156	104	78.0	62.4	52.0	39.0	31.2	24.9	20.8	17.8
	3.5	XC	4.26	3.8	4.1	168	112	84.1	67.3	56.1	42.0	33.6	26.9	22.4	19.2	156	104	77.9	62.3	52.0	39.0	31.2	24.9	20.8	17.8
(B)1/4XP20R (B)1/4XP20L	1.5	UC	5.56	2.7	3.4	309	206	154	124	103	77.2	61.8	49.4	41.2	35.3	245	164	123	98.1	81.8	61.3	49.1	39.2	32.7	28.0
	2.0	UC	6.43	3.5	3.7	276	184	138	110	91.9	68.9	55.1	44.1	36.7	31.5	261	174	130	104	86.9	65.2	52.1	41.7	34.8	29.8
	3.0	XC	7.87	4.1	4.3	288	192	144	115	96.0	72.0	57.6	46.1	38.4	32.9	275	183	137	110	91.5	68.6	54.9	43.9	36.6	31.4
	3.5	XC	8.52	4.4	4.6	290	194	145	116	96.8	72.6	58.1	46.5	38.7	33.2	278	185	139	111	92.6	69.5	55.6	44.5	37.0	31.8
(B)1/4XP25R (B)1/4XP25L	1.5	UC	9.12	4.6	4.9	297	198	149	119	99.1	74.3	59.5	47.6	39.7	34.0	279	186	140	112	93.1	69.8	55.8	44.7	37.2	31.9
	2.0	UC	10.5	4.4	4.6	358	239	179	143	119	89.5	71.6	57.3	47.7	40.9	342	228	171	137	114	85.6	68.5	54.8	45.7	39.1
	3.0	UC	9.77	4.1	4.4	357	238	179	143	119	89.4	71.5	57.2	47.7	40.9	333	222	167	133	111	83.3	66.6	53.3	44.4	38.1
	3.5	XC	10.5	4.4	4.6	358	239	179	143	119	89.5	71.6	57.3	47.7	40.9	342	228	171	137	114	85.6	68.5	54.8	45.7	39.1
(B)1/2XP40R (B)1/2XP40L	1.5	UC	11.2	4.6	4.9	365	243	183	146	122	91.3	73.0	58.4	48.7	41.7	343	229	171	137	114	85.7	68.6	54.9	45.7	39.2
	2.0	UC	11.2	3.4	3.7	494	329	247	198	165	124	98.8	79.1	65.9	56.5	454	303	227	182	151	114	90.8	72.6	60.5	51.9
	3.0	UC	13.1	4.0	4.4	491	328	246	197	164	123	98.3	78.6	65.5	56.1	447	298	223	179	149	112	89.3	71.5	59.5	51.0
	3.5	UC	15.9	4.3	4.7	555	370	277	222	185	139	111	88.7	74.0	63.4	507	338	254	203	169	127	101	81.2	67.7	58.0
(B)1/2XP80R (B)1/2XP80L	1.5	UC	17.0	4.6	4.9	554	370	277	222	185	139	111	88.7	73.9	63.4	520	347	260	208	173	130	104	83.3	69.4	59.5
	2.0	UC	18.4	4.9	5.3	563	376	282	225	188	141	113	90.1	75.1	64.4	521	347	260	208	174	130	104	83.3	69.4	59.5
	3.0	UC	22.1	4.0	4.7	829	553	414	332	276	207	166	133	111	94.7	705	470	353	282	235	176	141	113	94.0	80.6
	4.0	UC	25.5	4.6	5.0	832	554	416	333	277	208	166	133	111	95.0	765	510	383	306	255	191	153	122	102	87.4
(B)1/2XP80R (B)1/2XP80L	3.0	UC	31.1	4.9	5.3	952	635	476	381	317	238	190	152	127	109	880	587	440	352	293	220	176	141	117	101
	3.5	UC	33.2	5.0	5.5	996	664	498	398	332	249	199	159	133	114	905	604	453	362	302	226	181	145	121	103
	4.0	UC	35.8	5.3	5.6	1013	675	507	405	338	253	203	162	135	116	959	639	479	384	320	240	192	153	128	110

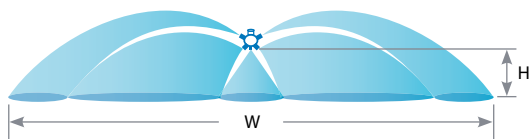

W = Maximum effective coverage with nozzle mounted at 1 m height.



**5880-3/4 NPT Female**  
Back inlet connection.



**5430-3/4 NPT**

TIP PART NO.	6733-OC06 (2)	H1/4VV-1506 (2)	H1/4VVL-9502 with 50 mesh strainer (1)	bar	l/min	"W" (METERS)	l/ha				
							6 km/h	8 km/h	12 km/h	16 km/h	24 km/h
5430-3/4-2TOC06 5880-3/4-2TOC06				1.5	7.26	10.2	71.2	53.4	35.6	26.7	17.8
				2.0	8.38	10.3	81.4	61.0	40.7	30.5	20.3
				2.5	9.37	10.5	89.2	66.9	44.6	33.5	22.3
5430-3/4-2TOC10 5880-3/4-2TOC10	OC-10	H1/4U-0508HE	H1/4VVL-11004 with 50 mesh strainer	1.5	11.16	12.0	93.0	69.8	46.5	34.9	23.3
				2.0	12.89	12.1	107	79.9	53.3	39.9	26.6
				2.5	14.41	12.3	117	87.9	58.6	43.9	29.3
5430-3/4-2TOC20 5880-3/4-2TOC20	OC-20	H1/4U-0520HE	H1/4VVL-9506 with 50 mesh strainer	1.5	24.00	14.3	168	126	83.9	62.9	42.0
				2.0	27.72	15.2	182	137	91.2	68.4	45.6
				2.5	30.99	15.8	196	147	98.1	73.6	49.0
5430-3/4-2TOC40 5880-3/4-2TOC40	OC-40	H1/4U-0540HE	H1/4U-9510	1.5	47.44	17.1	277	208	139	104	69.4
				2.0	54.78	18.2	301	226	150	113	75.2
				2.5	61.25	19.2	319	239	160	120	79.8

**Note:** Always double check your application rates. Tabulations are based on spraying water at 21°C. See technical information (pages 179–202) for useful formulas and other technical information.

### HOW TO ORDER

5 8 8 0 - 3 / 4 - 2 T O C 0 6

### EXTRA-WIDE FLAT SPRAY COVERAGE

W = Maximum effective coverage with nozzle mounted at 1 m height.

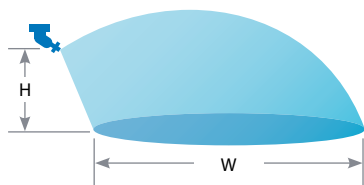

### HOW TO ORDER

4 6 2 9 - 3 / 4 - T O C 1 0  
Brass



**Type 4629-3/4-TOC Single Swivel**  
with 3/4" NPT (F) pipe connection. Brass.



**Type 4418-3/4-2TOC Double Swivel**  
with 3/4" NPT (F) pipe connection. Brass.

TIP PART NO.	bar	l/min	"W" (METERS)	HEIGHT = 90 cm		
				l/ha		
				4 km/h	16 km/h	24 km/h
4629-3/4-TOC10	2.0	3.23	5.4	44.9	22.4	15.0
	3.0	3.95	5.6	52.9	26.5	17.6
	4.0	4.56	5.6	61.1	30.5	20.4
4629-3/4-TOC20	2.0	6.45	7.1	68.1	34.1	22.7
	3.0	7.90	7.4	80.1	40.0	26.7
	4.0	9.12	7.4	92.4	46.2	30.8
4629-3/4-TOC40	2.0	12.89	7.9	122	61.2	40.8
	3.0	15.79	8.2	144	72.2	48.1
	4.0	18.23	8.2	167	83.4	55.6
4629-3/4-TOC80	2.0	25.78	8.8	220	110	73.3
	3.0	31.58	9.1	260	130	86.8
	4.0	36.47	9.1	301	150	100
4629-3/4-TOC150	2.0	48.34	9.3	390	195	130
	3.0	59.21	9.6	463	231	154
	4.0	68.37	9.6	534	267	178
4629-3/4-TOC300	2.0	96.68	9.7	748	374	249
	3.0	118.41	10.0	888	444	296
	4.0	136.73	10.2	1005	503	335

**Note:** Always double check your application rates. Tabulations are based on spraying water at 21°C. See technical information (pages 179–202) for useful formulas and other technical information.



## Typical Applications



**HERBICIDE**  
SOIL APPLIED  
**EXCELLENT**  
SYSTEMIC  
**EXCELLENT**



**FERTILIZER**  
BROADCAST  
**EXCELLENT**



**DRIFT CONTROL**  
**EXCELLENT**



**Type 1/4-KLC**  
1/4" NPT male pipe connections

## FEATURES

- The KLC FieldJet nozzle is typically used to spray areas not accessible with a boom sprayer.
- Its one-piece nozzle design projects spray to both sides to form a wide swath flat spray.

- The round orifice minimizes clogging.
- Uniformity across the swath is not as good as with a properly operated boom sprayer.\*

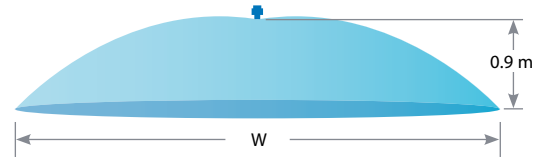

\*Uniformity can be optimized by double overlapping spray swaths on successive sprayer passes. Remember, this also doubles the application volume.

TIP PART NO.	bar	CAPACITY ONE NOZZLE IN l/min	"W" (METERS)	l/ha						
				3 km/h	4 km/h	5 km/h	6 km/h	8 km/h	10 km/h	12 km/h
1/4-KLC-5	0.7	1.91	4.3	88.8	66.6	53.3	44.4	33.3	26.7	22.2
	1.0	2.28	5.2	87.7	65.8	52.6	43.8	32.9	26.3	21.9
	2.0	3.23	5.5	117	88.1	70.5	58.7	44.0	35.2	29.4
	3.0	3.95	6.4	123	92.6	74.1	61.7	46.3	37.0	30.9
1/4-KLC-9	0.7	3.43	4.9	140	105	84.0	70.0	52.5	42.0	35.0
	1.0	4.10	5.5	149	112	89.5	74.5	55.9	44.7	37.3
	2.0	5.80	5.8	200	150	120	100	75.0	60.0	50.0
	3.0	7.10	6.4	222	166	133	111	83.2	66.6	55.5
1/4-KLC-18	0.7	6.86	5.5	249	187	150	125	93.5	74.8	62.4
	1.0	8.20	6.1	269	202	161	134	101	80.7	67.2
	2.0	11.6	6.4	363	272	218	181	136	109	90.6
	3.0	14.2	6.7	424	318	254	212	159	127	106
1/4-KLC-36	0.7	13.7	5.8	472	354	283	236	177	142	118
	1.0	16.4	6.7	490	367	294	245	184	147	122
	2.0	23.2	7.3	636	477	381	318	238	191	159
	3.0	28.4	7.9	719	539	431	359	270	216	180

**Note:** Always double check your application rates. Tabulations are based on spraying water at 21°C. See technical information (pages 179–202) for useful formulas and other technical information.

## SPRAY PATTERN

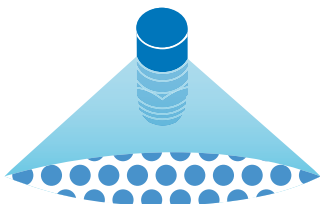

## MATERIALS AVAILABLE

- SS** STAINLESS STEEL
- B** BRASS

## HOW TO ORDER

Stainless Steel  
**1 / 4 K L C - S S 1 8**  
 Tip Type      Material Code      Capacity Size

### Typical Applications



**HERBICIDE**  
SOIL APPLIED  
**EXCELLENT**  
SYSTEMIC  
**EXCELLENT**



**FUNGICIDE**  
SYSTEMIC  
**GOOD**



**INSECTICIDE**  
SYSTEMIC  
**GOOD**



**FERTILIZER**  
BROADCAST  
**EXCELLENT**



**DRIFT CONTROL**  
**EXCELLENT**



### FEATURES

- Wide, even spray pattern allows fewer passes through the field and the ability to cover more area with each pass.
- XE TeeJet Tip can be used in a wide variety of applications—fruits & vegetables, greenhouses, home gardens, urban pest control, sugar cane and flowers.
- Designed for use in hand-held and boomless sprayer applications.
- Optimal use at low pressure.
- Optimum spray height of 50 cm and optimum spray pressure at 2 bar.
- Removable pre-orifice for cleaning.
- Acetal polymer material for durability.
- Available in four VisiFlo Polymer (VP) capacities.
- Can be used with 114445A-\*-CELR Quick TeeJet cap and gasket, CP8027-NYB nylon threaded cap, and CP1325 brass threaded cap. Reference page 118 for more information.

### SPRAY PATTERN

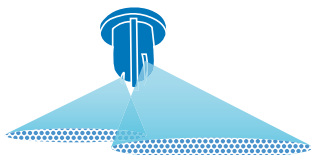

### DROPLET SIZE CLASSIFICATION

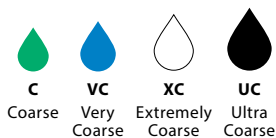

### RECOMMENDED PRESSURE RANGE



### MATERIALS AVAILABLE



### HOW TO ORDER

Polymer with VisiFlo® color-coding

**X E 1 5 0 0 8 - V P**

Tip Type	Spray Angle	Capacity Size	Material Code

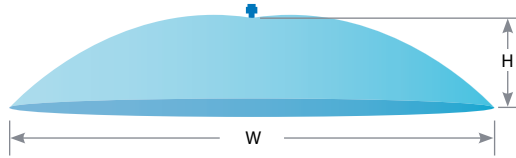

TIP PART NO. (STRAINER MESH SIZE)	BAR	DROP SIZE	CAPACITY ONE TIP IN l/min	SPRAY WIDTH "W" (METERS)		L/HA															
				60 cm HEIGHT	90 cm HEIGHT	HEIGHT "Y" = 60 cm								HEIGHT "Y" = 90 cm							
						4 km/h	5 km/h	6 km/h	8 km/h	10 km/h	12 km/h	15 km/h	20 km/h	4 km/h	5 km/h	6 km/h	8 km/h	10 km/h	12 km/h	15 km/h	20 km/h
XE15002-VP (50)	0.5	UC	0.32	1.2	1.4	40.2	32.2	26.8	20.1	16.1	13.4	10.7	8.0	34.5	27.6	23.0	17.2	13.8	11.5	9.2	6.9
	1.0	UC	0.46	1.7	2.3	40.2	32.1	26.8	20.1	16.1	13.4	10.7	8.0	29.7	23.8	19.8	14.8	11.9	9.9	7.9	5.9
	1.5	UC	0.56	2.2	2.8	38.0	30.4	25.4	19.0	15.2	12.7	10.1	7.6	29.9	23.9	19.9	14.9	12.0	10.0	8.0	6.0
	2.0	XC	0.64	2.7	3.4	35.8	28.6	23.9	17.9	14.3	11.9	9.5	7.2	28.4	22.7	18.9	14.2	11.4	9.5	7.6	5.7
	3.0	VC	0.79	3.3	4.2	35.9	28.7	23.9	17.9	14.3	12.0	9.6	7.2	28.2	22.5	18.8	14.1	11.3	9.4	7.5	5.6
	4.0	VC	0.91	3.7	4.8	36.9	29.6	24.6	18.5	14.8	12.3	9.9	7.4	28.5	22.8	19.0	14.2	11.4	9.5	7.6	5.7
XE15004-VP (50)	0.5	UC	0.70	1.6	1.9	65.6	52.5	43.7	32.8	26.2	21.9	17.5	13.1	55.3	44.2	36.8	27.6	22.1	18.4	14.7	11.1
	1.0	UC	0.96	2.5	3.0	57.4	46.0	38.3	28.7	23.0	19.1	15.3	11.5	47.9	38.3	31.9	23.9	19.1	16.0	12.8	9.6
	1.5	UC	1.15	3.2	3.9	53.9	43.1	35.9	27.0	21.6	18.0	14.4	10.8	44.2	35.4	29.5	22.1	17.7	14.7	11.8	8.8
	2.0	XC	1.31	3.7	4.5	53.1	42.5	35.4	26.5	21.2	17.7	14.2	10.6	43.7	34.9	29.1	21.8	17.5	14.6	11.6	8.7
	3.0	VC	1.57	4.3	5.0	54.9	43.9	36.6	27.4	21.9	18.3	14.6	11.0	47.2	37.8	31.5	23.6	18.9	15.7	12.6	9.4
	4.0	VC	1.79	4.7	5.2	57.2	45.7	38.1	28.6	22.9	19.1	15.2	11.4	51.7	41.3	34.5	25.8	20.7	17.2	13.8	10.3
XE15006-VP (50)	0.5	UC	0.97	2.1	2.7	69.0	55.2	46.0	34.5	27.6	23.0	18.4	13.8	53.7	43.0	35.8	26.8	21.5	17.9	14.3	10.7
	1.0	UC	1.37	3.0	3.8	68.3	54.7	45.6	34.2	27.3	22.8	18.2	13.7	54.0	43.2	36.0	27.0	21.6	18.0	14.4	10.8
	1.5	UC	1.67	3.6	4.2	69.8	55.8	46.5	34.9	27.9	23.3	18.6	14.0	59.8	47.8	39.9	29.9	23.9	19.9	15.9	12.0
	2.0	XC	1.93	4.2	4.6	69.0	55.2	46.0	34.5	27.6	23.0	18.4	13.8	63.0	50.4	42.0	31.5	25.2	21.0	16.8	12.6
	3.0	VC	2.37	4.7	5.2	75.6	60.5	50.4	37.8	30.2	25.2	20.2	15.1	68.3	54.6	45.5	34.2	27.3	22.8	18.2	13.7
	4.0	C	2.73	5.1	5.7	80.4	64.3	53.6	40.2	32.2	26.8	21.4	16.1	72.0	57.6	48.0	36.0	28.8	24.0	19.2	14.4
XE15008-VP (50)	0.5	UC	1.30	2.3	2.7	84.7	67.8	56.5	42.4	33.9	28.2	22.6	16.9	72.2	57.7	48.1	36.1	28.9	24.1	19.2	14.4
	1.0	UC	1.83	3.2	3.9	85.9	68.7	57.3	42.9	34.4	28.6	22.9	17.2	70.5	56.4	47.0	35.2	28.2	23.5	18.8	14.1
	1.5	UC	2.24	3.6	4.3	93.3	74.7	62.2	46.7	37.3	31.1	24.9	18.7	78.1	62.5	52.1	39.1	31.3	26.0	20.8	15.6
	2.0	XC	2.58	3.9	4.7	99.4	79.5	66.2	49.7	39.7	33.1	26.5	19.9	82.5	66.0	55.0	41.2	33.0	27.5	22.0	16.5
	3.0	VC	3.16	4.4	4.9	107.7	86.1	71.8	53.8	43.1	35.9	28.7	21.5	96.7	77.4	64.5	48.3	38.7	32.2	25.8	19.3
	4.0	C	3.64	4.6	5.1	118.8	95.0	79.2	59.4	47.5	39.6	31.7	23.8	107.1	85.7	71.4	53.6	42.9	35.7	28.6	21.4

**Note:** Always double check your application rates. Droplet size classification shown is based on ISO 25358. Droplet size classification standard is subject to change. Tabulations are based on spraying water at 21°C. See technical information (pages 179–202) for droplet size classification, useful formulas and other technical information.

## Typical Applications



**HERBICIDE**  
SOIL APPLIED  
**VERY GOOD**  
SYSTEMIC  
**EXCELLENT**



**FUNGICIDE**  
SYSTEMIC  
**GOOD**



**INSECTICIDE**  
SYSTEMIC  
**VERY GOOD**



**DRIFT CONTROL**  
**EXCELLENT**



## FEATURES

- Non-tapered flat spray pattern with a 65° or 95° angle providing even coverage without overlapping.
- Air-induction spray tip producing large air-filled droplets through the use of a Venturi air aspirator.
- Ideal for banding over the row or in row middles.
- Available with stainless steel insert, polymer holder and pre-orifice with VisiFlo® color-coding in eight capacities for the AI95° and six capacities for the AI65°.

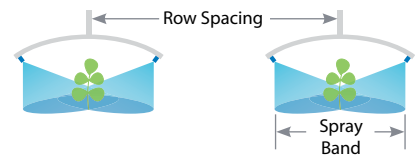

- Automatic spray alignment with 114443A\*-CELR Quick TeeJet cap and gasket. Reference page 118 for more information.

## SPRAY PATTERN

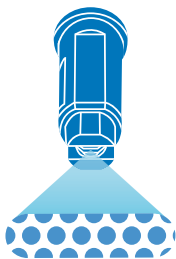

## DROPLET SIZE CLASSIFICATION

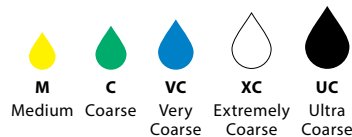

## OPTIMUM SPRAY HEIGHT

	HEIGHT		l/ha CONVERSION FACTORS	
	65°	95°	50 cm	75 cm
20 cm	16 cm	10 cm	2.50	3.75
25 cm	20 cm	13 cm	2.00	3.00
30 cm	24 cm	15 cm	1.67	2.50
40 cm	31 cm	20 cm	1.25	1.88

To find l/ha on the spray band, multiply the tabulated l/ha from the following page for row spacing by the conversion factors above.

Example:

- Spray Band = 20 cm
- Row Spacing = 75 cm (Conversion Factor = 3.75)
- AI9501EVS at 3 bar at 8 km/h – 59 l/ha
- Corrected l/ha = 59 x 3.75 = 221.25 l/ha

## RECOMMENDED PRESSURE RANGE



2-8 bar

## MATERIALS AVAILABLE

**VS** STAINLESS STEEL

## HOW TO ORDER

Polymer with VisiFlo color-coding

**A I 9 5 0 4 E V S**

Tip Type    Capacity Size    Material Code  
Spray Pattern

TIP PART NO. (STRAINER MESH SIZE)	bar	DROP SIZE		CAPACITY ONE TIP IN l/min	APPLICATION RATE FOR 50 cm SPRAY TIP SPACING						APPLICATION RATE FOR 75 cm SPRAY TIP SPACING					
		65°	95°		l/ha						l/ha					
		4 km/h	6 km/h		8 km/h	10 km/h	15 km/h	20 km/h	4 km/h	6 km/h	8 km/h	10 km/h	15 km/h	20 km/h		
AI95015EVS (100)	2.0		XC	0.48	144	96.0	72.0	57.6	38.4	28.8	96.0	64.0	48.0	38.4	25.6	19.2
	3.0		XC	0.59	177	118	88.5	70.8	47.2	35.4	118	78.7	59.0	47.2	31.5	23.6
	4.0		VC	0.68	204	136	102	81.6	54.4	40.8	136	90.7	68.0	54.4	36.3	27.2
	5.0		VC	0.76	228	152	114	91.2	60.8	45.6	152	101	76.0	60.8	40.5	30.4
	6.0		C	0.83	249	166	125	99.6	66.4	49.8	166	111	83.0	66.4	44.3	33.2
	7.0		C	0.90	270	180	135	108	72.0	54.0	180	120	90.0	72.0	48.0	36.0
8.0		M	0.96	288	192	144	115	76.8	57.6	192	128	96.0	76.8	51.2	38.4	
AI6502EVS AI9502EVS (50)	2.0	UC	XC	0.65	195	130	97.5	78.0	52.0	39.0	130	86.7	65.0	52.0	34.7	26.0
	3.0	XC	XC	0.79	237	158	119	94.8	63.2	47.4	158	105	79.0	63.2	42.1	31.6
	4.0	VC	VC	0.91	273	182	137	109	72.8	54.6	182	121	91.0	72.8	48.5	36.4
	5.0	VC	VC	1.02	306	204	153	122	81.6	61.2	204	136	102	81.6	54.4	40.8
	6.0	VC	C	1.12	336	224	168	134	89.6	67.2	224	149	112	89.6	59.7	44.8
	7.0	C	C	1.21	363	242	182	145	96.8	72.6	242	161	121	96.8	64.5	48.4
8.0	C	C	1.29	387	258	194	155	103	77.4	258	172	129	103	68.8	51.6	
AI65025EVS AI95025EVS (50)	2.0	UC	XC	0.81	243	162	122	97.2	64.8	48.6	162	108	81.0	64.8	43.2	32.4
	3.0	XC	XC	0.99	297	198	149	119	79.2	59.4	198	132	99.0	79.2	52.8	39.6
	4.0	XC	VC	1.14	342	228	171	137	91.2	68.4	228	152	114	91.2	60.8	45.6
	5.0	VC	VC	1.28	384	256	192	154	102	76.8	256	171	128	102	68.3	51.2
	6.0	VC	C	1.40	420	280	210	168	112	84.0	280	187	140	112	74.7	56.0
	7.0	VC	C	1.51	453	302	227	181	121	90.6	302	201	151	121	80.5	60.4
8.0	C	C	1.62	486	324	243	194	130	97.2	324	216	162	130	86.4	64.8	
AI6503EVS AI9503EVS (50)	2.0	UC	XC	0.96	288	192	144	115	76.8	57.6	192	128	96.0	76.8	51.2	38.4
	3.0	XC	XC	1.18	354	236	177	142	94.4	70.8	236	157	118	94.4	62.9	47.2
	4.0	XC	VC	1.36	408	272	204	163	109	81.6	272	181	136	109	72.5	54.4
	5.0	VC	VC	1.52	456	304	228	182	122	91.2	304	203	152	122	81.1	60.8
	6.0	VC	C	1.67	501	334	251	200	134	100	334	223	167	134	89.1	66.8
	7.0	C	C	1.80	540	360	270	216	144	108	360	240	180	144	96.0	72.0
8.0	C	C	1.93	579	386	290	232	154	116	386	257	193	154	103	77.2	
AI6504EVS AI9504EVS (50)	2.0	UC	XC	1.29	387	258	194	155	103	77.4	258	172	129	103	68.8	51.6
	3.0	XC	XC	1.58	474	316	237	190	126	94.8	316	211	158	126	84.3	63.2
	4.0	VC	VC	1.82	546	364	273	218	146	109	364	243	182	146	97.1	72.8
	5.0	VC	VC	2.04	612	408	306	245	163	122	408	272	204	163	109	81.6
	6.0	C	C	2.23	669	446	335	268	178	134	446	297	223	178	119	89.2
	7.0	C	C	2.41	723	482	362	289	193	145	482	321	241	193	129	96.4
8.0	C	C	2.58	774	516	387	310	206	155	516	344	258	206	138	103	
AI6505EVS AI9505EVS (50)	2.0	UC	XC	1.61	483	322	242	193	129	96.6	322	215	161	129	85.9	64.4
	3.0	XC	XC	1.97	591	394	296	236	158	118	394	263	197	158	105	78.8
	4.0	XC	VC	2.27	681	454	341	272	182	136	454	303	227	182	121	90.8
	5.0	VC	VC	2.54	762	508	381	305	203	152	508	339	254	203	135	102
	6.0	VC	C	2.79	837	558	419	335	223	167	558	372	279	223	149	112
	7.0	VC	C	3.01	903	602	452	361	241	181	602	401	301	241	161	120
8.0	VC	C	3.22	966	644	483	386	258	193	644	429	322	258	172	129	
AI6506EVS AI9506EVS (50)	2.0	UC	UC	1.94	582	388	291	233	155	116	388	259	194	155	103	77.6
	3.0	XC	XC	2.37	711	474	356	284	190	142	474	316	237	190	126	94.8
	4.0	XC	VC	2.74	822	548	411	329	219	164	548	365	274	219	146	110
	5.0	XC	VC	3.06	918	612	459	367	245	184	612	408	306	245	163	122
	6.0	VC	VC	3.35	1005	670	503	402	268	201	670	447	335	268	179	134
	7.0	VC	C	3.62	1086	724	543	434	290	217	724	483	362	290	193	145
8.0	VC	C	3.87	1161	774	581	464	310	232	774	516	387	310	206	155	
AI9508EVS (50)	2.0		UC	2.58	774	516	387	310	206	155	516	344	258	206	138	103
	3.0		XC	3.16	948	632	474	379	253	190	632	421	316	253	169	126
	4.0		VC	3.65	1095	730	548	438	292	219	730	487	365	292	195	146
	5.0		VC	4.08	1224	816	612	490	326	245	816	544	408	326	218	163
	6.0		VC	4.47	1341	894	671	536	358	268	894	596	447	358	238	179
	7.0		C	4.83	1449	966	725	580	386	290	966	644	483	386	258	193
8.0		C	5.16	1548	1032	774	619	413	310	1032	688	516	413	275	206	

**Note:** Always double check your application rates. Droplet size classification shown is based on ISO 25358. Droplet size classification standard is subject to change. Tabulations are based on spraying water at 21°C. See technical information (pages 179–202) for droplet size classification, useful formulas and other technical information.



## Typical Applications



**HERBICIDE**  
SOIL APPLIED  
**EXCELLENT**  
SYSTEMIC  
**EXCELLENT**



**FUNGICIDE**  
SYSTEMIC  
**GOOD**



**INSECTICIDE**  
SYSTEMIC  
**GOOD**



**DRIFT CONTROL**  
**VERY GOOD**



## FEATURES

- Non-tapered flat spray pattern with a 95° angle providing even coverage without overlapping.
- Pre-orifice design produces large droplets to reduce drift.
- Ideal for soil applied and systemic herbicide applications.
- Ideal for banding over the row or in row middles.
- Available with stainless steel insert, polymer holder and pre-orifice with VisiFlo color-coding in five capacities.
- Automatic spray alignment with 114441A-\***CEL**R Quick TeeJet® cap and gasket.

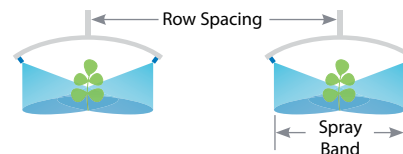

## SPRAY PATTERN

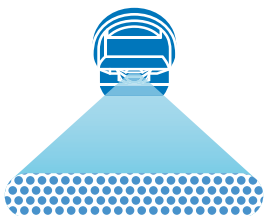

## DROPLET SIZE CLASSIFICATION

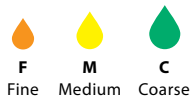

## OPTIMUM SPRAY HEIGHT

HEIGHT	95°	l/ha CONVERSION FACTORS	
		50 cm	75 cm
20 cm	10 cm	2.50	3.75
25 cm	13 cm	2.00	3.00
30 cm	15 cm	1.67	2.50
40 cm	20 cm	1.25	1.88

To find l/ha on the spray band, multiply the tabulated l/ha from the following page for row spacing by the conversion factors above.

Example:

- Spray Band = 20 cm
- Row spacing = 75cm (Conversion Factor = 3.75)
- DG95015EVS at 3 bar at 8 km/h – 59 l/ha
- Corrected l/ha = 59 x 3.75 = 221.25 l/ha

## RECOMMENDED PRESSURE RANGE



2-4 bar

## MATERIALS AVAILABLE

**VS** STAINLESS STEEL

## HOW TO ORDER

Stainless Steel with VisiFlo® color-coding

D G 9 5 0 1 5 E V S

Tip Type

Capacity Size

Material Code

Spray Pattern

TIP PART NO. (STRAINER MESH SIZE)	bar	DROP SIZE	CAPACITY ONE TIP IN l/min	APPLICATION RATE FOR 50 cm SPRAY TIP SPACING						APPLICATION RATE FOR 75 cm SPRAY TIP SPACING					
				l/ha						l/ha					
				4 km/h	6 km/h	8 km/h	10 km/h	15 km/h	20 km/h	4 km/h	6 km/h	8 km/h	10 km/h	15 km/h	20 km/h
DG95015EVS (100)	2.0	M	0.48	144	96.0	72.0	57.6	38.4	28.8	96.0	64.0	48.0	38.4	25.6	19.2
	2.5	M	0.54	162	108	81.0	64.8	43.2	32.4	108	72.0	54.0	43.2	28.8	21.6
	3.0	F	0.59	177	118	88.5	70.8	47.2	35.4	118	78.7	59.0	47.2	31.5	23.6
	4.0	F	0.68	204	136	102	81.6	54.4	40.8	136	90.7	68.0	54.4	36.3	27.2
DG9502EVS (50)	2.0	M	0.65	195	130	97.5	78.0	52.0	39.0	130	86.7	65.0	52.0	34.7	26.0
	2.5	M	0.72	216	144	108	86.4	57.6	43.2	144	96.0	72.0	57.6	38.4	28.8
	3.0	M	0.79	237	158	119	94.8	63.2	47.4	158	105	79.0	63.2	42.1	31.6
	4.0	M	0.91	273	182	137	109	72.8	54.6	182	121	91.0	72.8	48.5	36.4
DG9503EVS (50)	2.0	M	0.96	288	192	144	115	76.8	57.6	192	128	96.0	76.8	51.2	38.4
	2.5	M	1.08	324	216	162	130	86.4	64.8	216	144	108	86.4	57.6	43.2
	3.0	M	1.18	354	236	177	142	94.4	70.8	236	157	118	94.4	62.9	47.2
	4.0	M	1.36	408	272	204	163	109	81.6	272	181	136	109	72.5	54.4
DG9504EVS (50)	2.0	C	1.29	387	258	194	155	103	77.4	258	172	129	103	68.8	51.6
	2.5	M	1.44	432	288	216	173	115	86.4	288	192	144	115	76.8	57.6
	3.0	M	1.58	474	316	237	190	126	94.8	316	211	158	126	84.3	63.2
	4.0	M	1.82	546	364	273	218	146	109	364	243	182	146	97.1	72.8
DG9505EVS (50)	2.0	C	1.61	483	322	242	193	129	96.6	322	215	161	129	85.9	64.4
	2.5	C	1.80	540	360	270	216	144	108	360	240	180	144	96.0	72.0
	3.0	C	1.97	591	394	296	236	158	118	394	263	197	158	105	78.8
	4.0	M	2.27	681	454	341	272	182	136	454	303	227	182	121	90.8

**Note:** Always double check your application rates. Droplet size classification shown is based on ISO 25358. Droplet size classification standard is subject to change. Tabulations are based on spraying water at 21°C. See technical information (pages 179–202) for droplet size classification, useful formulas and other technical information.



## Typical Applications



**HERBICIDE**  
SOIL APPLIED  
**EXCELLENT**  
CONTACT  
**VERY GOOD**  
SYSTEMIC  
**GOOD**



**FUNGICIDE**  
CONTACT  
**EXCELLENT**  
SYSTEMIC  
**GOOD**



**INSECTICIDE**  
CONTACT  
**EXCELLENT**  
SYSTEMIC  
**GOOD**



**DRIFT CONTROL**  
**GOOD**



BANDING NOZZLES

## FEATURES

- Non-tapered flat spray pattern providing even coverage without overlapping.
- Ideal for banding over the row or in row middles.

- Available with VisiFlo® color-coding in stainless steel or all stainless steel, hardened stainless steel and brass even pattern in 30°, 40°, 65°, 80°, 95°, and 110°.
- Automatic spray alignment with 114441A\*-CELRL Quick TeeJet cap and gasket.

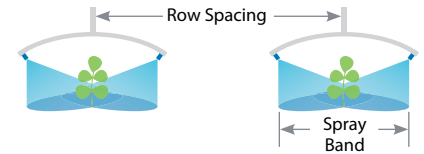

## SPRAY PATTERN

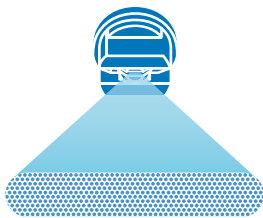

## DROPLET SIZE CLASSIFICATION

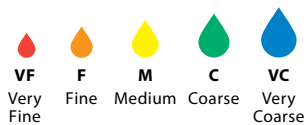

## OPTIMUM SPRAY HEIGHT

HEIGHT	HEIGHT					l/ha CONVERSION FACTORS	
	40°	65°	80°	95°	110°	50 cm	75 cm
20 cm	27 cm	16 cm	12 cm	9 cm	7 cm	2.50	3.75
25 cm	34 cm	20 cm	15 cm	11 cm	9 cm	2.00	3.00
30 cm	41 cm	24 cm	18 cm	14 cm	11 cm	1.67	2.50
40 cm	55 cm	31 cm	24 cm	18 cm	14 cm	1.25	1.88

To find l/ha on the spray band, multiply the tabulated l/ha from the following page for row spacing by the conversion factors above.

Example:

- Spray Band = 20 cm
- Row Spacing = 75 cm (Conversion Factor = 3.75)
- TP95015EVS at 3 bar at 8 km/h – 59 l/ha
- Corrected l/ha = 59 x 3.75 = 221.25 l/ha

## RECOMMENDED PRESSURE RANGE



## MATERIALS AVAILABLE

- VS** STAINLESS STEEL
- B** BRASS
- SS** STAINLESS STEEL
- HSS** HARDENED STAINLESS STEEL

TIP PART NO. (STRAINER MESH SIZE)	bar	DROP SIZE	CAPACITY ONE TIP IN l/min	APPLICATION RATE FOR 50 cm SPRAY TIP SPACING						APPLICATION RATE FOR 75 cm SPRAY TIP SPACING					
				l/ha						l/ha					
				4 km/h	6 km/h	8 km/h	10 km/h	15 km/h	20 km/h	4 km/h	6 km/h	8 km/h	10 km/h	15 km/h	20 km/h
TP4001E† TP6501E†	2.0	F	0.32	96.0	64.0	48.0	38.4	25.6	19.2	64.0	42.7	32.0	25.6	17.1	12.8
	2.5	F	0.36	108	72.0	54.0	43.2	28.8	21.6	72.0	48.0	36.0	28.8	19.2	14.4
TP8001E TP9501E (100)	3.0	F	0.39	117	78.0	58.5	46.8	31.2	23.4	78.0	52.0	39.0	31.2	20.8	15.6
	4.0	VF	0.45	135	90.0	67.5	54.0	36.0	27.0	90.0	60.0	45.0	36.0	24.0	18.0
TP40015E† TP65015E†	2.0	F	0.48	144	96.0	72.0	57.6	38.4	28.8	96.0	64.0	48.0	38.4	25.6	19.2
	2.5	F	0.54	162	108	81.0	64.8	43.2	32.4	108	72.0	54.0	43.2	28.8	21.6
TP80015E TP95015E (100)	3.0	F	0.59	177	118	88.5	70.8	47.2	35.4	118	78.7	59.0	47.2	31.5	23.6
	4.0	F	0.68	204	136	102	81.6	54.4	40.8	136	90.7	68.0	54.4	36.3	27.2
TP4002E† TP6502E†	2.0	M	0.65	195	130	97.5	78.0	52.0	39.0	130	86.7	65.0	52.0	34.7	26.0
	2.5	F	0.72	216	144	108	86.4	57.6	43.2	144	96.0	72.0	57.6	38.4	28.8
TP8002E TP9502E (50)	3.0	F	0.79	237	158	119	94.8	63.2	47.4	158	105	79.0	63.2	42.1	31.6
	4.0	F	0.91	273	182	137	109	72.8	54.6	182	121	91.0	72.8	48.5	36.4
TP4003E† TP6503E†	2.0	M	0.96	288	192	144	115	76.8	57.6	192	128	96.0	76.8	51.2	38.4
	2.5	M	1.08	324	216	162	130	86.4	64.8	216	144	108	86.4	57.6	43.2
TP8003E TP9503E (50)	3.0	F	1.18	354	236	177	142	94.4	70.8	236	157	118	94.4	62.9	47.2
	4.0	F	1.36	408	272	204	163	109	81.6	272	181	136	109	72.5	54.4
TP4004E† TP6504E†	2.0	M	1.29	387	258	194	155	103	77.4	258	172	129	103	68.8	51.6
	2.5	M	1.44	432	288	216	173	115	86.4	288	192	144	115	76.8	57.6
TP8004E TP9504E (50)	3.0	M	1.58	474	316	237	190	126	94.8	316	211	158	126	84.3	63.2
	4.0	F	1.82	546	364	273	218	146	109	364	243	182	146	97.1	72.8
TP4005E† TP6505E†	2.0	M	1.61	483	322	242	193	129	96.6	322	215	161	129	85.9	64.4
	2.5	M	1.80	540	360	270	216	144	108	360	240	180	144	96.0	72.0
TP8005E TP9505E (50)	3.0	M	1.97	591	394	296	236	158	118	394	263	197	158	105	78.8
	4.0	M	2.27	681	454	341	272	182	136	454	303	227	182	121	90.8
TP4006E† TP6506E†	2.0	C	1.94	582	388	291	233	155	116	388	259	194	155	103	77.6
	2.5	M	2.16	648	432	324	259	173	130	432	288	216	173	115	86.4
TP8006E TP9506E (50)	3.0	M	2.37	711	474	356	284	190	142	474	316	237	190	126	94.8
	4.0	M	2.74	822	548	411	329	219	164	548	365	274	219	146	110
TP6508E† TP11008E†	2.0	C	2.58	774	516	387	310	206	155	516	344	258	206	138	103
	2.5	C	2.88	864	576	432	346	230	173	576	384	288	230	154	115
TP8008E TP9508E (50)	3.0	M	3.16	948	632	474	379	253	190	632	421	316	253	169	126
	4.0	M	3.65	1095	730	548	438	292	219	730	487	365	292	195	146
TP4010E† TP6510E† TP8010E† TP11010E† (24)	2.0	C	3.23	969	646	485	388	258	194	646	431	323	258	172	129
	2.5	C	3.61	1083	722	542	433	289	217	722	481	361	289	193	144
	3.0	C	3.95	1185	790	593	474	316	237	790	527	395	316	211	158
	4.0	M	4.56	1368	912	684	547	365	274	912	608	456	365	243	182
TP6515E† TP8015E† TP11015E†	2.0	VC	4.83	1449	966	725	580	386	290	966	644	483	386	258	193
	2.5	C	5.40	1620	1080	810	648	432	324	1080	720	540	432	288	216
	3.0	C	5.92	1776	1184	888	710	474	355	1184	789	592	474	316	237
	4.0	C	6.84	2052	1368	1026	821	547	410	1368	912	684	547	365	274

**Note:** Always double check your application rates. Droplet size classification shown is based on ISO 25358. Droplet size classification standard is subject to change. Tabulations are based on spraying water at 21°C. See technical information (pages 179–202) for droplet size classification, useful formulas and other technical information.

†Available in brass and/or stainless steel and/or hardened stainless steel.

### HOW TO ORDER

Stainless Steel with VisiFlo color-coding

T P 8 0 0 2 E V S  
 Tip Type    Capacity Size    Material Code  
 Spray Pattern

Brass

T P 8 0 0 2 E  
 Tip Type    Capacity Size  
 Spray Pattern

Stainless Steel

T P 8 0 0 2 E - S S  
 Tip Type    Capacity Size    Material Code  
 Spray Pattern

Hardened Stainless Steel

T P 8 0 0 2 E - H S S  
 Tip Type    Capacity Size    Material Code  
 Spray Pattern

## Typical Applications



**HERBICIDE**  
CONTACT  
**VERY GOOD**



**FUNGICIDE**  
CONTACT  
**VERY GOOD**



**INSECTICIDE**  
CONTACT  
**VERY GOOD**



## FEATURES

- Non-tapered TwinJet flat spray pattern providing even coverage without overlapping.
- The twin flat sprays provide improved coverage and penetration of crop or weeds.
- Fine to medium droplet size is ideal when smaller droplets are necessary for contact products, as herbicides, insecticides, and fungicides.
- Ideal for banding over the row or in row middles.
- Available in stainless steel with VisiFlo® color-coding in 40° and 80° spray angles in four capacities.
- Automatic spray alignment with 114443A\*-CELR Quick TeeJet® cap and gasket. See page 118 for more information.

## SPRAY PATTERN

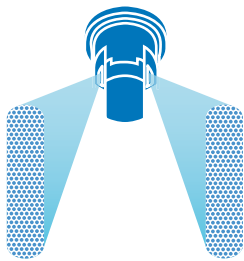

## DROPLET SIZE CLASSIFICATION

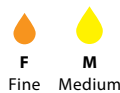

## OPTIMUM SPRAY HEIGHT

HEIGHT	I/ha CONVERSION FACTORS			
	40°	80°	50 cm	75 cm
20 cm	25 cm	13 cm	2.50	3.75
25 cm	30 cm	15 cm	2.00	3.00
30 cm	36 cm	18 cm	1.67	2.50
40 cm	48 cm	23 cm	1.25	1.88

To find I/ha on the spray band, multiply the tabulated I/ha from the following page for row spacing by the conversion factors above.

Example:

- Spray Band = 20 cm
- Row Spacing = 75 cm (Conversion Factor = 3.75)
- TJ60-8002EVS at 3 bar at 8 km/h – 59 I/ha
- Corrected I/ha = 79 x 3.75 = 296.25 I/ha

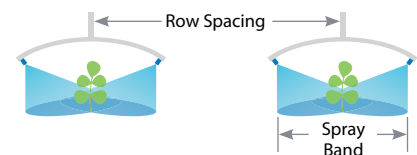

## RECOMMENDED PRESSURE RANGE



2-4 bar

## MATERIALS AVAILABLE

**VS** STAINLESS STEEL

## HOW TO ORDER

Stainless Steel with VisiFlo color-coding

**T J 6 0 - 4 0 0 2 E V S**

T	J	6	0	-	4	0	0	2	E	V	S
Tip Type	Spray Angle	Capacity Size	Material Code	Spray Pattern							



# TwinJet® EVEN FLAT SPRAY

TIP PART NO. (STRAINER MESH SIZE)	bar	DROP SIZE	CAPACITY ONE TIP IN l/min	APPLICATION RATE FOR 50 cm SPRAY TIP SPACING						APPLICATION RATE FOR 75 cm SPRAY TIP SPACING					
				l/ha						l/ha					
				4 km/h	6 km/h	8 km/h	10 km/h	15 km/h	20 km/h	4 km/h	6 km/h	8 km/h	10 km/h	15 km/h	20 km/h
TJ60-4002EVS TJ60-8002EVS (100)	2.0	F	0.65	195	130	97.5	78.0	52.0	39.0	130	86.7	65.0	52.0	34.7	26.0
	2.5	F	0.72	216	144	108	86.4	57.6	43.2	144	96.0	72.0	57.6	38.4	28.8
	3.0	F	0.79	237	158	119	94.8	63.2	47.4	158	105	79.0	63.2	42.1	31.6
	4.0	F	0.91	273	182	137	109	72.8	54.6	182	121	91.0	72.8	48.5	36.4
TJ60-4003EVS TJ60-8003EVS (100)	2.0	F	0.96	288	192	144	115	76.8	57.6	192	128	96.0	76.8	51.2	38.4
	2.5	F	1.08	324	216	162	130	86.4	64.8	216	144	108	86.4	57.6	43.2
	3.0	F	1.18	354	236	177	142	94.4	70.8	236	157	118	94.4	62.9	47.2
	4.0	F	1.36	408	272	204	163	109	81.6	272	181	136	109	72.5	54.4
TJ60-4004EVS TJ60-8004EVS (50)	2.0	F	1.29	387	258	194	155	103	77.4	258	172	129	103	68.8	51.6
	2.5	F	1.44	432	288	216	173	115	86.4	288	192	144	115	76.8	57.6
	3.0	F	1.58	474	316	237	190	126	94.8	316	211	158	126	84.3	63.2
	4.0	F	1.82	546	364	273	218	146	109	364	243	182	146	97.1	72.8
TJ60-8006EVS (50)	2.0	M	1.94	582	388	291	233	155	116	388	259	194	155	103	77.6
	2.5	M	2.16	648	432	324	259	173	130	432	288	216	173	115	86.4
	3.0	M	2.37	711	474	356	284	190	142	474	316	237	190	126	94.8
	4.0	F	2.74	822	548	411	329	219	164	548	365	274	219	146	110

**Note:** Always double check your application rates. Droplet size classification shown is based on ISO 25358. Droplet size classification standard is subject to change. Tabulations are based on spraying water at 21°C. See technical information (pages 179–202) for droplet size classification, useful formulas and other technical information.



### Typical Applications



**HERBICIDE**  
CONTACT  
**GOOD**  
SYSTEMIC  
**EXCELLENT**



**INSECTICIDE**  
SYSTEMIC  
**GOOD**



**FERTILIZER**  
BANDING  
**EXCELLENT**



**DRIFT CONTROL**  
**EXCELLENT**



BANDING NOZZLES

### FEATURES

- Air-Induction Spray tip producing large air-filled droplets through the use of a Venturi air aspirator.
- Off-center spray pattern with flat spray characteristics.
- 85° spray angle.
- Underleaf banding of pesticides or liquid fertilizers.
- Used at the end of the spray boom around the perimeter of the field to protect sensitive areas.
- Available with stainless steel insert, polymer holder and pre-orifice with VisiFlo® color-coding in four capacities.
- Automatic spray alignment with 114443A\*-CELR Quick TeeJet cap and gasket. See page 118 for more information.

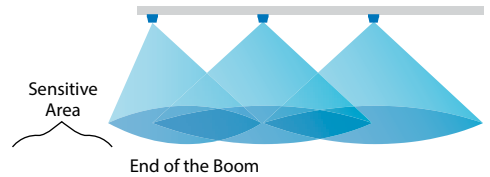
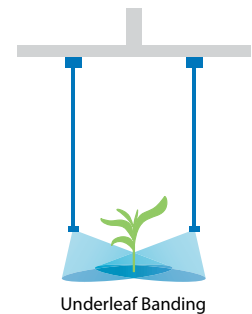
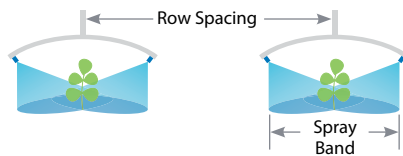

### SPRAY PATTERN

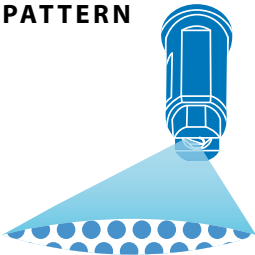

### DROPLET SIZE CLASSIFICATION

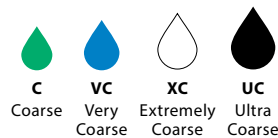

### RECOMMENDED PRESSURE RANGE



### MATERIALS AVAILABLE



### HOW TO ORDER

Stainless Steel with VisiFlo color-coding

**A I U B 8 5 0 2 5 V S**

Tip Type    Spray Angle    Capacity Size    Material Code



Visit [www.teejet.com](http://www.teejet.com) for updated charts.

TIP PART NO. (STRAINER MESH SIZE)	bar	DROP SIZE	CAPACITY ONE TIP IN l/min	APPLICATION RATE FOR 50 cm SPRAY TIP SPACING						APPLICATION RATE FOR 75 cm SPRAY TIP SPACING					
				l/ha						l/ha					
				4 km/h	6 km/h	8 km/h	10 km/h	15 km/h	20 km/h	4 km/h	6 km/h	8 km/h	10 km/h	15 km/h	20 km/h
AIUB8502 (50)	2.0	UC	0.65	195	130	97.5	78.0	52.0	39.0	130	86.7	65.0	52.0	34.7	26.0
	3.0	XC	0.79	237	158	119	94.8	63.2	47.4	158	105	79.0	63.2	42.1	31.6
	4.0	VC	0.91	273	182	137	109	72.8	54.6	182	121	91.0	72.8	48.5	36.4
	5.0	VC	1.02	306	204	153	122	81.6	61.2	204	136	102	81.6	54.4	40.8
	6.0	C	1.12	336	224	168	134	89.6	67.2	224	149	112	89.6	59.7	44.8
	7.0	C	1.21	363	242	182	145	96.8	72.6	242	161	121	96.8	64.5	48.4
	8.0		1.29	387	258	194	155	103	77.4	258	172	129	103	68.8	51.6
AIUB85025 (50)	2.0	UC	0.81	243	162	122	97.2	64.8	48.6	162	108	81.0	64.8	43.2	32.4
	3.0	XC	0.99	297	198	149	119	79.2	59.4	198	132	99.0	79.2	52.8	39.6
	4.0	VC	1.14	342	228	171	137	91.2	68.4	228	152	114	91.2	60.8	45.6
	5.0	VC	1.28	384	256	192	154	102	76.8	256	171	128	102	68.3	51.2
	6.0	C	1.40	420	280	210	168	112	84.0	280	187	140	112	74.7	56.0
	7.0	C	1.51	453	302	227	181	121	90.6	302	201	151	121	80.5	60.4
	8.0		1.62	486	324	243	194	130	97.2	324	216	162	130	86.4	64.8
AIUB8503 (50)	2.0	XC	0.96	288	192	144	115	76.8	57.6	192	128	96.0	76.8	51.2	38.4
	3.0	XC	1.18	354	236	177	142	94.4	70.8	236	157	118	94.4	62.9	47.2
	4.0	VC	1.36	408	272	204	163	109	81.6	272	181	136	109	72.5	54.4
	5.0	VC	1.52	456	304	228	182	122	91.2	304	203	152	122	81.1	60.8
	6.0	C	1.67	501	334	251	200	134	100	334	223	167	134	89.1	66.8
	7.0	C	1.80	540	360	270	216	144	108	360	240	180	144	96.0	72.0
	8.0		1.93	579	386	290	232	154	116	386	257	193	154	103	77.2
AIUB8504 (50)	2.0	XC	1.29	387	258	194	155	103	77.4	258	172	129	103	68.8	51.6
	3.0	XC	1.58	474	316	237	190	126	94.8	316	211	158	126	84.3	63.2
	4.0	VC	1.82	546	364	273	218	146	109	364	243	182	146	97.1	72.8
	5.0	VC	2.04	612	408	306	245	163	122	408	272	204	163	109	81.6
	6.0	C	2.23	669	446	335	268	178	134	446	297	223	178	119	89.2
	7.0	C	2.41	723	482	362	289	193	145	482	321	241	193	129	96.4
	8.0		2.58	774	516	387	310	206	155	516	344	258	206	138	103

**Note:** Always double check your application rates. Droplet size classification shown is based on ISO 25358. Droplet size classification standard is subject to change. Tabulations are based on spraying water at 21°C. See technical information (pages 179–202) for droplet size classification, useful formulas and other technical information.

BANDING NOZZLES

## FEATURES

- Off-center tip with tapered flat spray characteristics.
- 85° spray angle.
- Available in brass or stainless steel.
- Operating pressure 1.5–4 bar.
- Uniform distribution.
- Capacities of 0075 to 04.

## MATERIALS AVAILABLE

- SS** STAINLESS STEEL
- B** BRASS

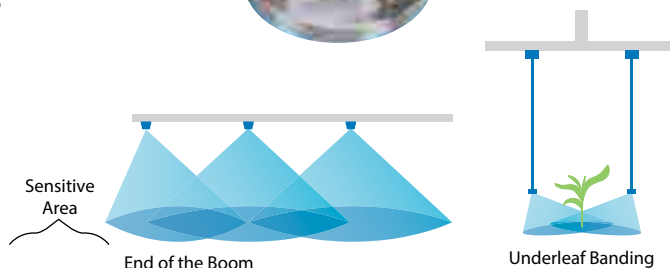

BANDING NOZZLES

TIP PART NO. (STRAINER MESH SIZE)	bar	CAPACITY TWO TIPS IN l/min	APPLICATION RATE FOR 75 cm SPRAY TIP SPACING (TWO SPRAY TIPS PER ROW)										
			3 km/h	3.5 km/h	4 km/h	4.5 km/h	5 km/h	5.5 km/h	6 km/h	6.5 km/h	7 km/h	7.5 km/h	8 km/h
D25143-UB-850075 (100)	1.5	0.42	112	96.0	84.0	74.7	67.2	61.1	56.0	51.7	48.0	44.8	42.0
	2.0	0.48	128	110	96.0	85.3	76.8	69.8	64.0	59.1	54.9	51.2	48.0
	2.5	0.54	144	123	108	96.0	86.4	78.5	72.0	66.5	61.7	57.6	54.0
	3.0	0.59	157	135	118	105	94.4	85.8	78.7	72.6	67.4	62.9	59.0
	3.5	0.64	171	146	128	114	102	93.1	85.3	78.8	73.1	68.3	64.0
D25143-UB-8501 (100)	1.5	0.56	149	128	112	99.6	89.6	81.5	74.7	68.9	64.0	59.7	56.0
	2.0	0.65	173	149	130	116	104	94.5	86.7	80.0	74.3	69.3	65.0
	2.5	0.72	192	165	144	128	115	105	96.0	88.6	82.3	76.8	72.0
	3.0	0.79	211	181	158	140	126	115	105	97.2	90.3	84.3	79.0
	3.5	0.85	227	194	170	151	136	124	113	105	97.1	90.7	85.0
D25143-UB-85015 (80)	1.5	0.83	221	190	166	148	133	121	111	102	94.9	88.5	83.0
	2.0	0.96	256	219	192	171	154	140	128	118	110	102	96.0
	2.5	1.08	288	247	216	192	173	157	144	133	123	115	108
	3.0	1.18	315	270	236	210	189	172	157	145	135	126	118
	3.5	1.27	339	290	254	226	203	185	169	156	145	135	127
D25143-UB-8502 (50)	1.5	1.12	299	256	224	199	179	163	149	138	128	119	112
	2.0	1.29	344	295	258	229	206	188	172	159	147	138	129
	2.5	1.44	384	329	288	256	230	209	192	177	165	154	144
	3.0	1.58	421	361	316	281	253	230	211	194	181	169	158
	3.5	1.71	456	391	342	304	274	249	228	210	195	182	171
D25143-UB-8503 (50)	1.5	1.68	448	384	336	299	269	244	224	207	192	179	168
	2.0	1.94	517	443	388	345	310	282	259	239	222	207	194
	2.5	2.16	576	494	432	384	346	314	288	266	247	230	216
	3.0	2.37	632	542	474	421	379	345	316	292	271	253	237
	3.5	2.56	683	585	512	455	410	372	341	315	293	273	256
D25143-UB-8504 (50)	1.5	2.23	595	510	446	396	357	324	297	274	255	238	223
	2.0	2.58	688	590	516	459	413	375	344	318	295	275	258
	2.5	2.88	768	658	576	512	461	419	384	354	329	307	288
	3.0	3.16	843	722	632	562	506	460	421	389	361	337	316
	3.5	3.41	909	779	682	606	546	496	455	420	390	364	341

**Note:** Always double check your application rates. Tabulations are based on spraying water at 21°C. See technical information (pages 179–202) for useful formulas and other technical information.

## FEATURES

- Provides coarse spray with full cone pattern.
- Used frequently for tobacco plant sucker control.

## SPRAY PATTERN

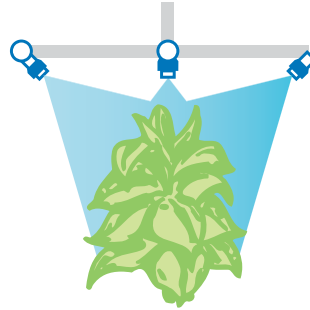
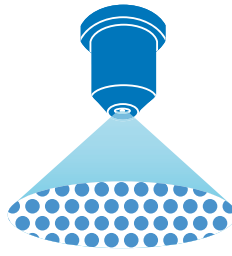

Three Spray Tips  
Per Row Spacing



TIP PART NO.	bar	CAPACITY ONE TIP IN l/min	APPLICATION RATE FOR 110 cm SPRAY TIP SPACING (THREE SPRAY TIPS PER ROW)				APPLICATION RATE FOR 120 cm SPRAY TIP SPACING (THREE SPRAY TIPS PER ROW)			
			4 km/h	5 km/h	6 km/h	8 km/h	4 km/h	5 km/h	6 km/h	8 km/h
TG-1	3.0	0.74	303	242	202	151	278	222	185	139
	4.0	0.85	348	278	232	174	319	255	213	159
	5.0	0.94	385	308	256	192	353	282	235	176
TG-2	3.0	1.49	610	488	406	305	559	447	373	279
	4.0	1.70	695	556	464	348	638	510	425	319
	5.0	1.88	769	615	513	385	705	564	470	353
TG-3	3.0	2.23	912	730	608	456	836	669	558	418
	4.0	2.55	1043	835	695	522	956	765	638	478
	5.0	2.82	1154	923	769	577	1058	846	705	529
TG-4	3.0	3.08	1260	1008	840	630	1155	924	770	578
	4.0	3.56	1456	1165	971	728	1335	1068	890	668
	5.0	3.98	1628	1303	1085	814	1493	1194	995	746
TG-5	3.0	3.72	1522	1217	1015	761	1395	1116	930	698
	4.0	4.25	1739	1391	1159	869	1594	1275	1063	797
	5.0	4.71	1927	1541	1285	963	1766	1413	1178	883
TG-6	3.0	4.59	1878	1502	1252	939	1721	1377	1148	861
	4.0	5.30	2168	1735	1445	1084	1988	1590	1325	994
	5.0	5.92	2422	1937	1615	1211	2220	1776	1480	1110
TG-8	3.0	6.17	2524	2019	1683	1262	2314	1851	1543	1157
	4.0	7.12	2913	2330	1942	1456	2670	2136	1780	1335
	5.0	7.96	3256	2605	2171	1628	2985	2388	1990	1493

**Note:** Always double check your application rates. Tabulations are based on spraying water at 21°C. See technical information (pages 179–202) for useful formulas and other technical information.



## Typical Applications



**FUNGICIDE**  
CONTACT  
**EXCELLENT**  
SYSTEMIC  
**GOOD**



**INSECTICIDE**  
CONTACT  
**EXCELLENT**  
SYSTEMIC  
**GOOD**

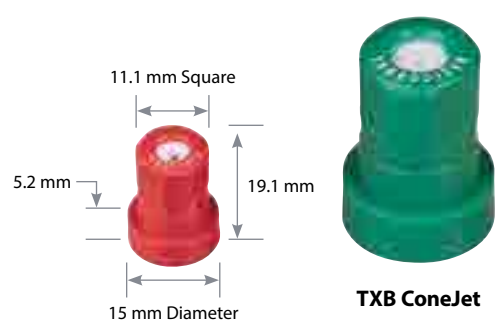
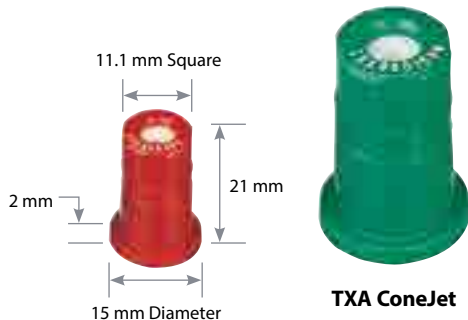

BANDING NOZZLES

### FEATURES

- Finely atomized spray pattern provides thorough coverage.
- Ideal for banding with two or three nozzles over the row.
- VisiFlo color-coded polypropylene body and ceramic orifice insert for long wear life.
- Resists corrosion.
- Accepts more abrasive materials.
- Available in seven VisiFlo® ceramic (VK) capacities.
- Can be used with 114445A-\*CELR caps and gasket. See page 118 for more information.

### RECOMMENDED PRESSURE RANGE



### MATERIALS AVAILABLE



### SPRAY PATTERN



### DROPLET SIZE CLASSIFICATION



### OPTIMUM SPRAY HEIGHT

	l/ha CONVERSION FACTORS	
	50 cm	75 cm
20 cm	2.50	3.75
25 cm	2.00	3.00
30 cm	1.67	2.50
40 cm	1.25	1.88

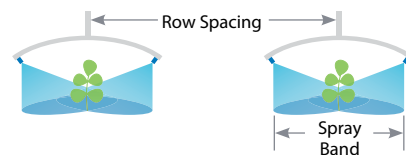

To find l/ha on the spray band, multiply the tabulated l/ha from the following page for row spacing by the conversion factors above.

- Example:
- Spray Band = 20 cm
  - Row Spacing = 75 cm (Conversion Factor = 3.75)
  - Two tips TXA8001 at 7 bar at 8 km/h – 116 l/ha
  - Corrected l/ha = 116 x 3.75 = 435 l/ha

### HOW TO ORDER

Ceramic with VisiFlo color-coding

**T X A 8 0 0 4 V K**

Tip Type    Spray Angle    Capacity Size    Material Code

Ceramic with VisiFlo color-coding

**T X B 8 0 0 1 5 V K**

Tip Type    Spray Angle    Capacity Size    Material Code

TIP PART NO. (STRAINER MESH SIZE)	bar	DROP SIZE	CAPACITY TWO SPRAY TIPS IN l/min	l/ha								CAPACITY THREE SPRAY TIPS IN l/min	l/ha							
				APPLICATION RATE FOR 50 cm SPRAY TIP SPACING				APPLICATION RATE FOR 75 cm SPRAY TIP SPACING					APPLICATION RATE FOR 50 cm SPRAY TIP SPACING				APPLICATION RATE FOR 75 cm SPRAY TIP SPACING			
				4 km/h	6 km/h	8 km/h	10 km/h	4 km/h	6 km/h	8 km/h	10 km/h		4 km/h	6 km/h	8 km/h	10 km/h	4 km/h	6 km/h	8 km/h	10 km/h
TXA800050VK TXB800050VK (100)	5.0	VF	0.50	150	100	75.0	60.0	100	66.7	50.0	40.0	0.75	225	150	113	90.0	150	100	75.0	60.0
	7.0	VF	0.56	168	112	84.0	67.2	112	74.7	56.0	44.8	0.84	252	168	126	101	168	112	84.0	67.2
	10.0	VF	0.66	198	132	99.0	79.2	132	88.0	66.0	52.8	0.99	297	198	149	119	198	132	99.0	79.2
	15.0	VF	0.78	234	156	117	93.6	156	104	78.0	62.4	1.17	351	234	176	140	234	156	117	93.6
	20.0	VF	0.90	270	180	135	108	180	120	90.0	72.0	1.35	405	270	203	162	270	180	135	108
TXA800067VK TXB800067VK (50)	5.0	VF	0.66	198	132	99.0	79.2	132	88.0	66.0	52.8	0.99	297	198	149	119	198	132	99.0	79.2
	7.0	VF	0.78	234	156	117	93.6	156	104	78.0	62.4	1.17	351	234	176	140	234	156	117	93.6
	10.0	VF	0.90	270	180	135	108	180	120	90.0	72.0	1.35	405	270	203	162	270	180	135	108
	15.0	VF	1.10	330	220	165	132	220	147	110	88.0	1.65	495	330	258	198	330	220	165	132
	20.0	VF	1.24	372	248	186	149	248	165	124	99.2	1.86	558	372	279	223	372	248	186	149
TXA8001VK TXB8001VK (50)	5.0	VF	1.00	300	200	150	120	200	133	100	80.0	1.50	450	300	225	180	300	200	150	120
	7.0	VF	1.16	348	232	174	139	232	155	116	92.8	1.74	522	348	261	209	348	232	174	139
	10.0	VF	1.36	408	272	204	163	272	181	136	109	2.04	612	408	306	245	408	272	204	163
	15.0	VF	1.64	492	328	246	197	328	219	164	131	2.46	738	492	369	295	492	328	246	197
	20.0	VF	1.86	558	372	279	223	372	248	186	149	2.79	837	558	419	335	558	372	279	223
TXA80015VK TXB80015VK (50)	5.0	VF	1.50	450	300	225	180	300	200	150	120	2.25	675	450	338	270	450	300	225	180
	7.0	VF	1.76	528	352	264	211	352	235	176	141	2.64	792	528	396	317	528	352	264	211
	10.0	VF	2.00	600	400	300	240	400	267	200	160	3.00	900	600	450	360	600	400	300	240
	15.0	VF	2.60	780	520	390	312	520	347	260	208	3.90	1170	780	585	468	780	520	390	312
	20.0	VF	3.00	900	600	450	360	600	400	300	240	4.50	1350	900	675	540	900	600	450	360
TXA8002VK TXB8002VK (50)	5.0	VF	2.00	600	400	300	240	400	267	200	160	3.00	900	600	450	360	600	400	300	240
	7.0	VF	2.40	720	480	360	288	480	320	240	192	3.60	1080	720	540	432	720	480	360	288
	10.0	VF	2.80	840	560	420	336	560	373	280	224	4.20	1260	840	630	504	840	560	420	336
	15.0	VF	3.40	1020	680	510	408	680	453	340	272	5.10	1530	1020	765	612	1020	680	510	408
	20.0	VF	4.00	1200	800	600	480	800	533	400	320	6.00	1800	1200	900	720	1200	800	600	480
TXA8002VK TXB8002VK (50)	5.0	VF	3.00	900	600	450	360	600	400	300	240	4.50	1350	900	675	540	900	600	450	360
	7.0	VF	3.60	1080	720	540	432	720	480	360	288	5.40	1620	1080	810	648	1080	720	540	432
	10.0	VF	4.40	1320	880	660	528	880	587	440	352	6.60	1980	1320	990	792	1320	880	660	528
	15.0	VF	5.20	1560	1040	780	624	1040	693	520	416	7.80	2340	1560	1170	936	1560	1040	780	624
	20.0	VF	6.00	1800	1200	900	720	1200	800	600	480	9.00	2700	1800	1350	1080	1800	1200	900	720
TXA8004VK TXB8004VK (50)	5.0	VF	4.20	1260	840	630	504	840	560	420	336	6.30	1890	1260	945	756	1260	840	630	504
	7.0	VF	4.80	1440	960	720	576	960	640	480	384	7.20	2160	1440	1080	864	1440	960	720	576
	10.0	VF	5.80	1740	1160	870	696	1160	773	580	464	8.70	2610	1740	1305	1044	1740	1160	870	696
	15.0	VF	7.20	2146	1440	1080	864	1440	960	720	576	10.80	3240	2160	1620	1296	2160	1440	1080	864
	20.0	VF	8.20	2460	1640	1230	984	1640	1093	820	656	12.30	3690	2460	1845	1476	2460	1640	1230	984

**Note:** Always double check your application rates. Droplet size classification shown is based on ISO 25358. Droplet size classification standard is subject to change. Tabulations are based on spraying water at 21°C. See technical information (pages 179–202) for droplet size classification, useful formulas and other technical information.



## Typical Applications



**FUNGICIDE**  
CONTACT  
**EXCELLENT**  
SYSTEMIC  
**GOOD**



**INSECTICIDE**  
CONTACT  
**EXCELLENT**  
SYSTEMIC  
**GOOD**



Three Spray Tips  
Per Row Spacing



## FEATURES

- Finely atomized spray pattern provides thorough coverage.
- Ideal for banding with two or three nozzles over the row.
- Color-coded versions consist of stainless steel or ceramic orifice in a polypropylene body. Maximum operating pressure 20 bar.
- Standard ConeJet (not color-coded) available in brass and stainless steel in a wide range of capacities with 65° (TY) and 80° (TX) spray angles.

## SPRAY PATTERN



## DROPLET SIZE CLASSIFICATION

**VF**  
Very  
Fine

## OPTIMUM SPRAY HEIGHT

	l/ha CONVERSION FACTORS	
	50 cm	75 cm
20 cm	2.50	3.75
25 cm	2.00	3.00
30 cm	1.67	2.50
40 cm	1.25	1.88

To find l/ha on the spray band, multiply the tabulated l/ha from the following page for row spacing by the conversion factors above.

Example:

- Band Width = 20 cm (Conversion Factor = 3.75)
- Two tips TX-VK3 at 3 bar at 8 km/h – 55.2 l/ha
- Corrected l/ha = 5.9 x 3.75 = 206.7 l/ha

## RECOMMENDED PRESSURE RANGE

2–20 bar

## MATERIALS AVAILABLE

**VS** STAINLESS STEEL

**VK** CERAMIC

**B** BRASS

**SS** STAINLESS STEEL

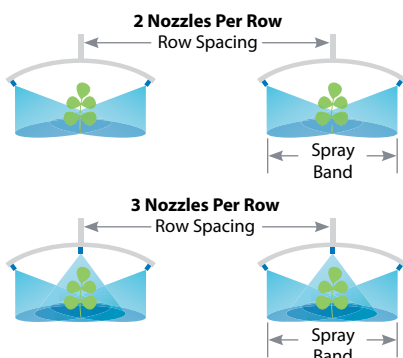

TIP PART NO. (STRAINER MESH SIZE)	bar	DROP SIZE	CAPACITY TWO TIPS IN l/min	l/ha								CAPACITY THREE TIPS IN l/min	l/ha							
				APPLICATION RATE FOR 50 cm SPRAY TIP SPACING				APPLICATION RATE FOR 75 cm SPRAY TIP SPACING					APPLICATION RATE FOR 50 cm SPRAY TIP SPACING				APPLICATION RATE FOR 75 cm SPRAY TIP SPACING			
				4 km/h	6 km/h	8 km/h	10 km/h	4 km/h	6 km/h	8 km/h	10 km/h		4 km/h	6 km/h	8 km/h	10 km/h	4 km/h	6 km/h	8 km/h	10 km/h
TX-1	5.0	VF	0.16	48.0	32.0	24.0	19.2	32.0	21.3	16.0	12.8	0.24	72.0	48.0	36.0	28.8	48.0	32.0	24.0	19.2
	7.0	VF	0.19	57.0	38.0	28.5	22.8	38.0	25.3	19.0	15.2	0.28	84.0	56.0	42.0	33.6	56.0	37.3	28.0	22.4
TX-t1 (100)	10.0	VF	0.22	66.0	44.0	33.0	26.4	44.0	29.3	22.0	17.6	0.33	99.0	66.0	49.5	39.6	66.0	44.0	33.0	26.4
	15.0	VF	0.26	78.0	52.0	39.0	31.2	52.0	34.7	26.0	20.8	0.39	117	78.0	58.5	46.8	78.0	52.0	39.0	31.2
TX-2	5.0	VF	0.32	96.0	64.0	48.0	38.4	64.0	42.7	32.0	25.6	0.48	144	96.0	72.0	57.6	96.0	64.0	48.0	38.4
	7.0	VF	0.38	114	76.0	57.0	45.6	76.0	50.7	38.0	30.4	0.57	171	114	85.5	68.4	114	76.0	57.0	45.6
TX-t2 (100)	10.0	VF	0.44	132	88.0	66.0	52.8	88.0	58.7	44.0	35.2	0.66	198	132	99.0	79.2	132	88.0	66.0	52.8
	15.0	VF	0.52	156	104	78.0	62.4	104	69.3	52.0	41.6	0.78	234	156	117	93.6	156	104	78.0	62.4
TX-3	5.0	VF	0.50	150	100	75.0	60.0	100	66.7	50.0	40.0	0.75	225	150	113	90.0	150	100	75.0	60.0
	7.0	VF	0.56	168	112	84.0	67.2	112	74.7	56.0	44.8	0.84	252	168	126	101	168	112	84.0	67.2
TX-t3 (100)	10.0	VF	0.66	198	132	99.0	79.2	132	88.0	66.0	52.8	0.99	297	198	149	119	198	132	99.0	79.2
	15.0	VF	0.78	234	156	117	93.6	156	104	78.0	62.4	1.17	351	234	176	140	234	156	117	93.6
TX-4	5.0	VF	0.66	198	132	99.0	79.2	132	88.0	66.0	52.8	0.99	297	198	149	119	198	132	99.0	79.2
	7.0	VF	0.78	234	156	117	93.6	156	104	78.0	62.4	1.17	351	234	176	140	234	156	117	93.6
TX-t4 (50)	10.0	VF	0.90	270	180	135	108	180	120	90.0	72.0	1.35	405	270	203	162	270	180	135	108
	15.0	VF	1.10	330	220	165	132	220	147	110	88.0	1.65	495	330	248	198	330	220	165	132
TX-6	5.0	VF	1.00	300	200	150	120	200	133	100	80.0	1.50	450	300	225	180	300	200	150	120
	7.0	VF	1.16	348	232	174	139	232	155	116	92.8	1.74	522	348	261	209	348	232	174	139
TX-t6 (50)	10.0	VF	1.36	408	272	204	163	272	181	136	109	2.04	612	408	306	245	408	272	204	163
	15.0	VF	1.64	492	328	246	197	328	219	164	131	2.46	738	492	369	295	492	328	246	197
TX-8	5.0	VF	1.34	402	268	201	161	268	179	134	107	2.01	603	402	302	241	402	268	201	161
	7.0	VF	1.58	474	316	237	190	316	211	158	126	2.37	711	474	356	284	474	316	237	190
TX-t8 (50)	10.0	VF	1.86	558	372	279	223	372	248	186	149	2.79	837	558	419	335	558	372	279	223
	15.0	VF	2.20	660	440	330	264	440	293	220	176	3.30	990	660	495	396	660	440	330	264
TX-10	5.0	VF	1.68	504	336	252	202	336	224	168	134	2.52	756	504	378	302	504	336	252	202
	7.0	VF	1.96	588	392	294	235	392	261	196	157	2.94	882	588	441	353	588	392	294	235
TX-t10 (50)	10.0	VF	2.40	720	480	360	288	480	320	240	192	3.60	1080	720	540	432	720	480	360	288
	15.0	VF	2.80	840	560	420	336	560	373	280	224	4.20	1260	840	630	504	840	560	420	336
TX-12	5.0	VF	2.00	600	400	300	240	400	267	200	160	3.00	900	600	450	360	600	400	300	240
	7.0	VF	2.40	720	480	360	288	480	320	240	192	3.60	1080	720	540	432	720	480	360	288
TX-t12 (50)	10.0	VF	2.80	840	560	420	336	560	373	280	224	4.20	1260	840	630	504	840	560	420	336
	15.0	VF	3.40	1020	680	510	408	680	453	340	272	5.10	1530	1020	765	612	1020	680	510	408
TX-18	5.0	VF	3.00	900	600	450	360	600	400	300	240	4.50	1350	900	675	540	900	600	450	360
	7.0	VF	3.60	1080	720	540	432	720	480	360	288	5.40	1620	1080	810	648	1080	720	540	432
TX-t18 (50)	10.0	VF	4.40	1320	880	660	528	880	587	440	352	6.60	1980	1320	990	792	1320	880	660	528
	15.0	VF	5.20	1560	1040	780	624	1040	693	520	416	7.80	2340	1560	1170	936	1560	1040	780	624
TX-26	5.0	VF	4.40	1320	880	660	528	880	587	440	352	6.60	1980	1320	990	792	1320	880	660	528
	7.0	VF	5.20	1560	1040	780	624	1040	693	520	416	7.80	2340	1560	1170	936	1560	1040	780	624
TX-t26 (50)	10.0	VF	6.20	1860	1240	930	744	1240	827	620	496	9.30	2790	1860	1395	1116	1860	1240	930	744
	15.0	VF	7.60	2280	1520	1140	912	1520	1013	760	608	11.4	3420	2280	1710	1368	2280	1520	1140	912
	20.0	VF	8.80	2640	1760	1320	1056	1760	1173	880	704	13.2	3960	2640	1980	1584	2640	1760	1320	1056

**Note:** Always double check your application rates. Droplet size classification shown is based on ISO 25358. Droplet size classification standard is subject to change. Tabulations are based on spraying water at 21°C. See technical information (pages 179–202) for droplet size classification, useful formulas and other technical information.

†Specify material.

## HOW TO ORDER

Stainless Steel with color-coding

**T X - V S 4**  
 |     |     |  
 Tip Material Capacity  
 Type Code Size

Brass

**T X - 4**  
 |     |  
 Tip Capacity  
 Type Size

Stainless Steel

**T X - S S 4**  
 |     |     |  
 Tip Material Capacity  
 Type Code Size

Ceramic with color-coding

**T X - V K 4**  
 |     |     |  
 Tip Material Capacity  
 Type Code Size

## Typical Applications



**FUNGICIDE**  
CONTACT  
**EXCELLENT**  
SYSTEMIC  
**GOOD**



**INSECTICIDE**  
CONTACT  
**EXCELLENT**  
SYSTEMIC  
**GOOD**



**FERTILIZER**  
**EXCELLENT**



AIR BLAST NOZZLES

## FEATURES

- Finely atomized spray pattern provides thorough coverage.
- Use for directed applications in air blast spraying for orchards and vineyards and other specialty crops.
- Color-coded version consists of stainless steel or ceramic orifice in polypropylene body.
- Spray angle is 80° at 7 bar.
- TX-VS1 and TX-VS2 available in VisiFlo® color-coded stainless steel only.
- Compatible with TeeJet cap CP20230 for use on rollovers and threaded nozzle bodies, tighten to a maximum torque of: 11 N-m.
- Uses 114445A-\*-CELR Quick TeeJet® cap and gasket. Reference page 118 for more information.

## SPRAY PATTERN



## DROPLET SIZE CLASSIFICATION



## RECOMMENDED PRESSURE RANGE



## MATERIALS AVAILABLE

- VS** STAINLESS STEEL
- VK** CERAMIC
- SS** STAINLESS STEEL
- B** BRASS



TIP PART NO.	STRAINER MESH SIZE	Capacity (l/min)																		
		2 bar	3 bar	4 bar	5 bar	6 bar	7 bar	8 bar	9 bar	10 bar	11 bar	12 bar	13 bar	14 bar	15 bar	16 bar	17 bar	18 bar	19 bar	20 bar
TX-VS1	100	0.055	0.065	0.074	0.081	0.087	0.093	0.098	0.103	0.108	0.112	0.116	0.120	0.124	0.127	0.131	0.134	0.137	0.140	0.143
		VF	VF	VF	VF	VF	VF	VF	VF	VF	VF	VF	VF	VF	VF	VF	VF	VF	VF	VF
TX-VS2	100	0.110	0.131	0.148	0.164	0.177	0.189	0.201	0.211	0.221	0.231	0.240	0.248	0.256	0.264	0.272	0.279	0.286	0.293	0.299
		VF	VF	VF	VF	VF	VF	VF	VF	VF	VF	VF	VF	VF	VF	VF	VF	VF	VF	VF
TX-VK3	100	0.164	0.196	0.223	0.245	0.266	0.284	0.301	0.317	0.332	0.346	0.359	0.372	0.384	0.396	0.407	0.418	0.429	0.439	0.449
		VF	VF	VF	VF	VF	VF	VF	VF	VF	VF	VF	VF	VF	VF	VF	VF	VF	VF	VF
TX-VK4	50	0.218	0.262	0.299	0.331	0.360	0.386	0.410	0.433	0.454	0.474	0.493	0.512	0.529	0.546	0.562	0.578	0.594	0.608	0.623
		VF	VF	VF	VF	VF	VF	VF	VF	VF	VF	VF	VF	VF	VF	VF	VF	VF	VF	VF
TX-VK6	50	0.327	0.393	0.448	0.496	0.539	0.579	0.615	0.649	0.681	0.711	0.740	0.767	0.794	0.819	0.844	0.867	0.890	0.912	0.934
		VF	VF	VF	VF	VF	VF	VF	VF	VF	VF	VF	VF	VF	VF	VF	VF	VF	VF	VF
TX-VK8	50	0.433	0.525	0.603	0.671	0.732	0.788	0.840	0.888	0.934	0.978	1.02	1.06	1.10	1.13	1.17	1.20	1.24	1.27	1.30
		VF	VF	VF	VF	VF	VF	VF	VF	VF	VF	VF	VF	VF	VF	VF	VF	VF	VF	VF
TX-VK10	50	0.541	0.657	0.753	0.838	0.915	0.985	1.05	1.11	1.17	1.22	1.27	1.32	1.37	1.42	1.46	1.50	1.55	1.59	1.63
		VF	VF	VF	VF	VF	VF	VF	VF	VF	VF	VF	VF	VF	VF	VF	VF	VF	VF	VF
TX-VK12	50	0.649	0.788	0.904	1.01	1.10	1.18	1.26	1.33	1.40	1.47	1.53	1.59	1.65	1.70	1.75	1.81	1.86	1.90	1.95
		VF	VF	VF	VF	VF	VF	VF	VF	VF	VF	VF	VF	VF	VF	VF	VF	VF	VF	VF
TX-VK18	50	0.968	1.18	1.37	1.53	1.67	1.80	1.93	2.04	2.15	2.25	2.35	2.45	2.54	2.63	2.72	2.80	2.88	2.96	3.03
		VF	VF	VF	VF	VF	VF	VF	VF	VF	VF	VF	VF	VF	VF	VF	VF	VF	VF	VF
TX-VK26	50	1.40	1.71	1.97	2.20	2.41	2.60	2.78	2.95	3.11	3.26	3.40	3.54	3.67	3.80	3.92	4.04	4.16	4.27	4.38
		F	VF	VF	VF	VF	VF	VF	VF	VF	VF	VF	VF	VF	VF	VF	VF	VF	VF	VF

**Note:** Always double check your application rates. Droplet size classification shown are based on ISO 25358. Droplet size is subject to change. Tabulations are based on spraying water at 21°C. See technical information (pages 179–202) for droplet size classification, useful formulas and other technical information.

## HOW TO ORDER

Stainless Steel with color-coding

**T X - V S 4**

Tip Type

Material Code

Brass

**T X - 4**

Tip Type

Ceramic with color-coding

**T X - V K 4**

Tip Type

Material Code

Stainless Steel

**T X - S S 4**

Tip Type

Material Code



## Typical Applications



**FUNGICIDE**  
CONTACT  
**EXCELLENT**  
SYSTEMIC  
**GOOD**



**INSECTICIDE**  
CONTACT  
**EXCELLENT**  
SYSTEMIC  
**GOOD**



**FERTILIZER**  
**EXCELLENT**

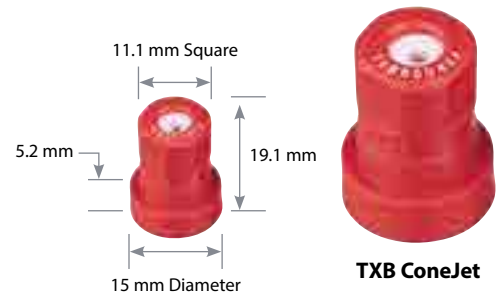
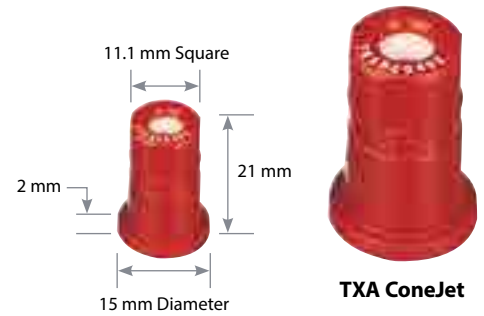

AIR BLAST NOZZLES

## FEATURES

- Use for directed applications in air blast spraying for orchards and vineyards and other specialty crops.
- Maximum operating pressure 20 bar. Spray angle is 80° at 7 bar.
- Finely atomized spray pattern provides thorough coverage.
- Longer wear life.
- Resists corrosion.
- Accepts more abrasive pesticide formulation.
- VisiFlo® color-code in a polypropylene body for use with corrosive materials and ceramic insert.
- TXA and TXB compatible with TeeJet cap CP20230 for use on rollovers and threaded nozzle bodies, tighten to a maximum torque of: 11 N-m.
- TXA uses 114445A-\* -CELR Quick TeeJet® cap and gasket. Reference page 118 for more information.
- TXB to be used with Albus® caps or equivalent.

## SPRAY PATTERN



## DROPLET SIZE CLASSIFICATION



## RECOMMENDED PRESSURE RANGE



## MATERIALS AVAILABLE



TIP PART NO.	STRAINER MESH SIZE	Capacity (l/min)																		
		2 bar	3 bar	4 bar	5 bar	6 bar	7 bar	8 bar	9 bar	10 bar	11 bar	12 bar	13 bar	14 bar	15 bar	16 bar	17 bar	18 bar	19 bar	20 bar
TX†800050VK	100	0.164	0.196	0.223	0.245	0.266	0.284	0.301	0.317	0.332	0.346	0.359	0.372	0.384	0.396	0.407	0.418	0.429	0.439	0.449
		VF	VF	VF	VF	VF	VF	VF	VF	VF	VF	VF	VF	VF	VF	VF	VF	VF	VF	VF
TX†800067VK	50	0.218	0.262	0.299	0.331	0.360	0.386	0.410	0.433	0.454	0.474	0.493	0.512	0.529	0.546	0.562	0.578	0.594	0.608	0.623
		VF	VF	VF	VF	VF	VF	VF	VF	VF	VF	VF	VF	VF	VF	VF	VF	VF	VF	VF
TX†8001VK	50	0.327	0.393	0.448	0.496	0.539	0.579	0.615	0.649	0.681	0.711	0.740	0.767	0.794	0.819	0.844	0.867	0.890	0.912	0.934
		VF	VF	VF	VF	VF	VF	VF	VF	VF	VF	VF	VF	VF	VF	VF	VF	VF	VF	VF
TX†80015VK	50	0.487	0.591	0.678	0.754	0.823	0.886	0.944	0.999	1.05	1.10	1.15	1.19	1.23	1.28	1.32	1.35	1.39	1.43	1.46
		VF	VF	VF	VF	VF	VF	VF	VF	VF	VF	VF	VF	VF	VF	VF	VF	VF	VF	VF
TX†8002VK	50	0.649	0.788	0.904	1.01	1.10	1.18	1.26	1.33	1.40	1.47	1.53	1.59	1.65	1.70	1.75	1.81	1.86	1.90	1.95
		VF	VF	VF	VF	VF	VF	VF	VF	VF	VF	VF	VF	VF	VF	VF	VF	VF	VF	VF
TX†8003VK	50	0.968	1.18	1.37	1.53	1.67	1.80	1.93	2.04	2.15	2.25	2.35	2.45	2.54	2.63	2.72	2.80	2.88	2.96	3.03
		VF	VF	VF	VF	VF	VF	VF	VF	VF	VF	VF	VF	VF	VF	VF	VF	VF	VF	VF
TX†8004VK	50	1.29	1.58	1.82	2.03	2.23	2.40	2.57	2.72	2.87	3.01	3.14	3.27	3.39	3.51	3.62	3.73	3.84	3.94	4.04
		F	VF	VF	VF	VF	VF	VF	VF	VF	VF	VF	VF	VF	VF	VF	VF	VF	VF	VF

**Note:** Always double check your application rates. Droplet size classification shown are based on ISO 25358. Droplet size is subject to change. Tabulations are based on spraying water at 21°C. See technical information (pages 179–202) for droplet size classification, useful formulas and other technical information.

†Specify "A" or "B."

## HOW TO ORDER

Ceramic with VisiFlo color-coding

**T X A 8 0 0 4 V K**

Tip Type	Spray Angle	Capacity Size	Material Code

Ceramic with VisiFlo color-coding

**T X B 8 0 0 4 V K**

Tip Type	Spray Angle	Capacity Size	Material Code



## Typical Applications



**FUNGICIDE**  
CONTACT  
**EXCELLENT**  
SYSTEMIC  
**GOOD**



**INSECTICIDE**  
CONTACT  
**EXCELLENT**  
SYSTEMIC  
**GOOD**



**FERTILIZER**  
BROADCAST  
**EXCELLENT**



AIR BLAST NOZZLES

## FEATURES

- Use for directed applications in air blast spraying for orchards and vineyards and other specialty crops.
- Produces uniform, 80° hollow cone spray pattern.
- Flow rates are matched to serve as a direct replacement for commonly used non-TeeJet hollow cone spray tips.
- High-quality ceramic orifice provides superior wear life, including high-pressure operation.
- Low profile acetal tip body provides minimal impact with foliage and excellent chemical resistance.
- Snap-fit backup plate provides positive retention when handled in field, but allows for tool-free removal for easy cleaning.
- Best suited for use with TeeJet 98450 series brass rollover valves and TeeJet cap CP20230, tighten to a maximum torque of: 11 N-m.
- Compatible with Quick TeeJet® Cap CP114395-1-NYB or 114396-1-NYR (cap, gasket, and O-ring). Reference page 119 for more information.

## SPRAY PATTERN



## DROPLET SIZE CLASSIFICATION



## RECOMMENDED PRESSURE RANGE



## MATERIALS AVAILABLE



# TXR ConeJet® HOLLOW CONE SPRAY

AIR BLAST NOZZLES

TIP PART NO.	STRAINER MESH SIZE	CAPACITY (l/min)																				
		2 bar	3 bar	4 bar	5 bar	6 bar	7 bar	8 bar	9 bar	10 bar	11 bar	12 bar	13 bar	14 bar	15 bar	16 bar	17 bar	18 bar	19 bar	20 bar	21 bar	22 bar
TXR800053VK	100	0.173	0.209	0.239	0.265	0.289	0.310	0.330	0.349	0.367	0.383	0.399	0.414	0.429	0.443	0.457	0.470	0.483	0.495	0.507	0.519	0.530
		VF	VF	VF	VF	VF	VF	VF	VF	VF	VF	VF	VF	VF	VF	VF	VF	VF	VF	VF	VF	VF
TXR800071VK	50	0.230	0.280	0.321	0.357	0.390	0.419	0.447	0.473	0.497	0.521	0.543	0.564	0.584	0.604	0.623	0.641	0.659	0.676	0.693	0.709	0.725
		VF	VF	VF	VF	VF	VF	VF	VF	VF	VF	VF	VF	VF	VF	VF	VF	VF	VF	VF	VF	VF
TXR8001VK	50	0.325	0.394	0.452	0.503	0.549	0.591	0.630	0.666	0.701	0.733	0.764	0.794	0.823	0.850	0.877	0.903	0.928	0.952	0.976	0.999	1.02
		VF	VF	VF	VF	VF	VF	VF	VF	VF	VF	VF	VF	VF	VF	VF	VF	VF	VF	VF	VF	VF
TXR80013VK	50	0.433	0.525	0.603	0.671	0.732	0.788	0.840	0.888	0.934	0.978	1.02	1.06	1.10	1.13	1.17	1.20	1.24	1.27	1.30	1.33	1.36
		VF	VF	VF	VF	VF	VF	VF	VF	VF	VF	VF	VF	VF	VF	VF	VF	VF	VF	VF	VF	VF
TXR80015VK	50	0.487	0.591	0.678	0.754	0.823	0.886	0.944	0.999	1.05	1.10	1.15	1.19	1.23	1.28	1.32	1.35	1.39	1.43	1.46	1.50	1.53
		VF	VF	VF	VF	VF	VF	VF	VF	VF	VF	VF	VF	VF	VF	VF	VF	VF	VF	VF	VF	VF
TXR80017VK	50	0.541	0.657	0.753	0.838	0.915	0.985	1.05	1.11	1.17	1.22	1.27	1.32	1.37	1.42	1.46	1.51	1.55	1.59	1.63	1.67	1.70
		VF	VF	VF	VF	VF	VF	VF	VF	VF	VF	VF	VF	VF	VF	VF	VF	VF	VF	VF	VF	VF
TXR8002VK	50	0.649	0.788	0.904	1.01	1.10	1.18	1.26	1.33	1.40	1.47	1.53	1.59	1.65	1.70	1.75	1.81	1.86	1.90	1.95	2.00	2.04
		VF	VF	VF	VF	VF	VF	VF	VF	VF	VF	VF	VF	VF	VF	VF	VF	VF	VF	VF	VF	VF
TXR80028VK	50	0.893	1.08	1.24	1.38	1.51	1.62	1.73	1.83	1.93	2.02	2.10	2.18	2.26	2.34	2.41	2.48	2.55	2.62	2.68	2.75	2.81
		VF	VF	VF	VF	VF	VF	VF	VF	VF	VF	VF	VF	VF	VF	VF	VF	VF	VF	VF	VF	VF
TXR8003VK	50	0.968	1.18	1.37	1.53	1.67	1.80	1.93	2.04	2.15	2.26	2.35	2.45	2.54	2.63	2.72	2.80	2.88	2.96	3.03	3.11	3.18
		VF	VF	VF	VF	VF	VF	VF	VF	VF	VF	VF	VF	VF	VF	VF	VF	VF	VF	VF	VF	VF
TXR80036VK	50	1.15	1.41	1.62	1.81	1.98	2.14	2.29	2.42	2.55	2.68	2.79	2.91	3.02	3.12	3.22	3.32	3.42	3.51	3.60	3.69	3.77
		VF	VF	VF	VF	VF	VF	VF	VF	VF	VF	VF	VF	VF	VF	VF	VF	VF	VF	VF	VF	VF
TXR8004VK	50	1.29	1.58	1.82	2.03	2.23	2.40	2.57	2.72	2.87	3.01	3.14	3.27	3.39	3.51	3.62	3.73	3.84	3.94	4.04	4.14	4.24
		F	VF	VF	VF	VF	VF	VF	VF	VF	VF	VF	VF	VF	VF	VF	VF	VF	VF	VF	VF	VF
TXR80049VK	50	1.58	1.93	2.22	2.48	2.72	2.93	3.13	3.32	3.50	3.67	3.83	3.99	4.14	4.28	4.42	4.55	4.69	4.81	4.94	5.06	5.18
		F	VF	VF	VF	VF	VF	VF	VF	VF	VF	VF	VF	VF	VF	VF	VF	VF	VF	VF	VF	VF

**Note:** Always double check your application rates. Droplet size classification shown are based on ISO 25358. Droplet size is subject to change. Tabulations are based on spraying water at 21°C. See technical information (pages 179–202) for droplet size classification, useful formulas and other technical information.

## HOW TO ORDER

Ceramic with color-coding

T X R 8 0 0 3 V K

Tip Spray Capacity Material  
Type Angle Size Code

Ceramic with color-coding, 100 Tip Pack

T X R 8 0 0 3 V K - 1 0 0 X

Tip Spray Capacity Material  
Type Angle Size Code



## Typical Applications



**FUNGICIDE**  
CONTACT  
**EXCELLENT**  
SYSTEMIC  
**VERY GOOD**



**INSECTICIDE**  
CONTACT  
**EXCELLENT**  
SYSTEMIC  
**VERY GOOD**



**FERTILIZER**  
**EXCELLENT**



**DRIFT CONTROL**  
**EXCELLENT**

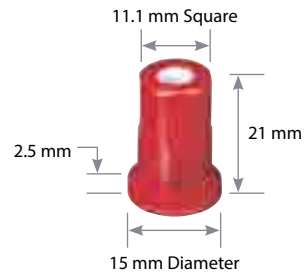

**AITXA ConeJet**

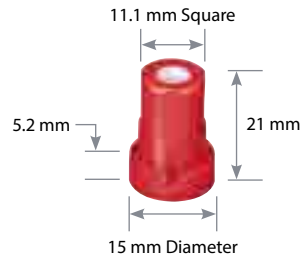

**AITXB ConeJet**



AIR BLAST NOZZLES

## FEATURES

- Hollow cone spray pattern is ideal for air blast and directed spray applications.
- Larger droplets are produced, compared to the standard TX ConeJet, through the use of a Venturi air aspirator resulting in reduced drift and improved canopy penetration.
- Constructed of polypropylene, ceramic and FKM for excellent chemical and wear resistance.
- Removable pre-orifice for fast and easy cleaning.
- AITXA to be used with 114445A-\* -CELR Quick TeeJet® cap.
- AITXB to be used with Albus® caps or equivalent.
- AITXA and AITXB Compatible with TeeJet cap CP20230 for use on rollovers and threaded nozzle bodies, tighten to a maximum torque of: 11 N-m.

## SPRAY PATTERN

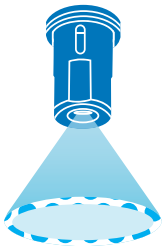

## DROPLET SIZE CLASSIFICATION

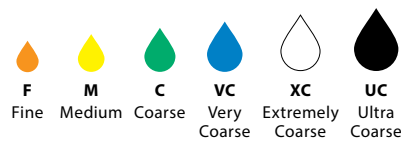

## RECOMMENDED PRESSURE RANGE



## MATERIALS AVAILABLE



TIP PART NO.	STRAINER MESH SIZE	CAPACITY (l/min)																
		4 bar	5 bar	6 bar	7 bar	8 bar	9 bar	10 bar	11 bar	12 bar	13 bar	14 bar	15 bar	16 bar	17 bar	18 bar	19 bar	20 bar
AITX†8001VK	50	0.449	0.499	0.545	0.586	0.625	0.661	0.695	0.727	0.758	0.787	0.816	0.843	0.869	0.895	0.920	0.944	0.967
		XC	VC	VC	VC	C	C	M	M	M	M	M	F	F	F	F	F	F
AITX†80015VK	50	0.674	0.753	0.824	0.889	0.950	1.01	1.06	1.11	1.16	1.21	1.25	1.30	1.34	1.38	1.42	1.46	1.49
		XC	VC	VC	VC	C	C	M	M	M	M	M	F	F	F	F	F	F
AITX†8002VK	50	0.920	1.03	1.13	1.22	1.30	1.38	1.46	1.53	1.60	1.67	1.73	1.79	1.85	1.91	1.96	2.02	2.07
		XC	VC	VC	VC	C	C	C	C	M	M	M	M	M	M	M	M	F
AITX†80025VK	50	1.12	1.25	1.37	1.48	1.58	1.67	1.77	1.85	1.93	2.01	2.09	2.16	2.23	2.30	2.37	2.43	2.49
		XC	XC	XC	VC	VC	VC	VC	C	C	C	M	M	M	M	M	M	F
AITX†8003VK	50	1.34	1.50	1.65	1.78	1.91	2.02	2.14	2.24	2.34	2.44	2.54	2.63	2.72	2.80	2.88	2.96	3.04
		XC	XC	XC	VC	VC	VC	VC	C	C	C	M	M	M	M	M	M	F
AITX†8004VK	50	1.79	2.00	2.20	2.38	2.54	2.70	2.85	2.99	3.13	3.26	3.38	3.50	3.62	3.74	3.85	3.95	4.06
		UC	UC	XC	VC	VC	VC	VC	C	C	C	C	C	M	M	M	M	M

**Note:** Always double check your application rates. Droplet size classification shown are based on ISO 25358. Droplet size is subject to change. Tabulations are based on spraying water at 21°C. See technical information (pages 179–202) for droplet size classification, useful formulas and other technical information.

†Specify "A" or "B."

### HOW TO ORDER

Ceramic with VisiFlo color-coding

A I T X A 8 0 0 1 V K

Tip Type    Spray Angle    Capacity Size    Material Code

Ceramic with VisiFlo color-coding

A I T X B 8 0 0 1 V K

Tip Type    Spray Angle    Capacity Size    Material Code



# TeeJet® VISIFLO® FLAT SPRAY

## FEATURES

- Use for directed applications in air blast spraying for orchards and vineyards and other specialty crops.
- Tapered-edge flat spray pattern for uniform coverage.
- VisiFlo color-coded version available with ceramic orifice for long wear life.



## SPRAY PATTERN

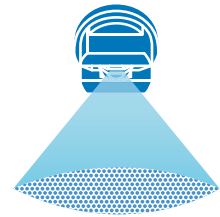

## RECOMMENDED PRESSURE RANGE



2–20 bar

## MATERIALS AVAILABLE

**VK** CERAMIC

TIP PART NO.	STRAINER MESH SIZE	CAPACITY (l/min)																		
		2 bar	3 bar	4 bar	5 bar	6 bar	7 bar	8 bar	9 bar	10 bar	11 bar	12 bar	13 bar	14 bar	15 bar	16 bar	17 bar	18 bar	19 bar	20 bar
TP8001VK	100	0.32	0.39	0.45	0.50	0.55	0.60	0.64	0.68	0.71	0.75	0.78	0.81	0.84	0.87	0.90	0.93	0.96	0.98	1.01
TP8001SVK	100	0.48	0.59	0.68	0.76	0.83	0.90	0.96	1.02	1.08	1.13	1.18	1.23	1.27	1.32	1.36	1.40	1.45	1.48	1.52
TP8002VK	50	0.65	0.79	0.91	1.02	1.12	1.21	1.29	1.37	1.44	1.51	1.58	1.64	1.71	1.77	1.82	1.88	1.94	1.99	2.04
XR8003VK	50	0.96	1.18	1.36	1.52	1.67	1.80	1.93	2.04	2.15	2.26	2.36	2.46	2.55	2.64	2.73	2.81	2.89	2.97	3.05
XR8004VK	50	1.29	1.58	1.82	2.04	2.23	2.41	2.58	2.74	2.88	3.03	3.16	3.29	3.41	3.53	3.65	3.76	3.87	3.98	4.08
XR8005VK	50	1.61	1.97	2.27	2.54	2.79	3.01	3.22	3.41	3.60	3.77	3.94	4.10	4.26	4.41	4.55	4.69	4.83	4.96	5.09
XR8006VK	50	1.94	2.37	2.74	3.06	3.35	3.62	3.87	4.10	4.33	4.54	4.74	4.93	5.12	5.30	5.47	5.64	5.81	5.96	6.12
XR8008VK	50	2.58	3.16	3.65	4.08	4.47	4.83	5.16	5.47	5.77	6.05	6.32	6.58	6.83	7.07	7.30	7.52	7.74	7.95	8.16

**Note:** Always double check your application rates. Tabulations are based on spraying water at 21°C. See technical information (pages 179–202) for useful formulas and other technical information.

# ConeJet® HOLLOW CONE SPRAY

## Typical Assembly



4514-NY  
Slotted Strainer\*



TXR Tip

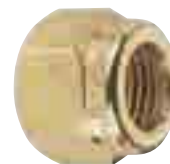

CP20230  
TeeJet Cap

\*Use CP20229-NY gasket when 4514-NY Nylon slotted strainer is not used.

### 98450 Double Outlet Rollover

For a complete listing of rollover options, see page 139.

## Typical Applications



**FUNGICIDE**  
CONTACT  
**EXCELLENT**  
SYSTEMIC  
**GOOD**



**INSECTICIDE**  
CONTACT  
**EXCELLENT**  
SYSTEMIC  
**GOOD**



**FERTILIZER**  
**EXCELLENT**

## SPRAY PATTERN

Produced by cores #13, 23, 25, 45 and 46.



DISC	CORE	DISC DIA. (mm)	CAPACITY (l/min)										ANGLE		
			0.7 bar	1 bar	2 bar	3 bar	4 bar	5 bar	6 bar	10 bar	15 bar	20 bar	1 bar	10 bar	20 bar
D1	DC13	0.79	—	—	0.22	0.26	0.29	0.32	0.34	0.43	0.50	0.57	—	66°	68°
D1.5	DC13	0.91	—	—	0.25	0.29	0.33	0.36	0.39	0.48	0.56	0.63	—	70°	72°
D2	DC13	1.0	—	0.22	0.29	0.33	0.37	0.41	0.44	0.53	0.63	0.70	41°	74°	75°
D3	DC13	1.2	—	0.24	0.30	0.35	0.41	0.44	0.48	0.59	0.68	0.77	45°	77°	78°
D4	DC13	1.6	0.27	0.31	0.40	0.47	0.53	0.59	0.63	0.76	0.89	1.0	64°	84°	85°
D1	DC23	0.79	—	—	0.24	0.28	0.32	0.34	0.38	0.46	0.54	0.61	—	63°	65°
D1.5	DC23	0.91	—	—	0.28	0.34	0.39	0.42	0.46	0.58	0.69	0.78	—	66°	67°
D2	DC23	1.0	—	0.28	0.37	0.43	0.49	0.53	0.57	0.70	0.83	0.93	43°	72°	72°
D3	DC23	1.2	0.25	0.29	0.39	0.46	0.52	0.58	0.62	0.78	0.93	1.1	56°	77°	77°
D4	DC23	1.6	0.32	0.37	0.51	0.61	0.70	0.77	0.83	1.1	1.3	1.4	62°	88°	88°
D5	DC23	2.0	0.37	0.44	0.59	0.72	0.82	0.91	0.98	1.3	1.5	1.7	73°	96°	95°
D6	DC23	2.4	0.42	0.50	0.69	0.83	0.95	1.1	1.2	1.5	1.8	2.0	79°	100°	99°
D1	DC25	0.79	—	—	0.33	0.40	0.45	0.50	0.54	0.69	0.83	0.95	—	49°	51°
D1.5	DC25	0.91	—	—	0.45	0.53	0.61	0.67	0.73	0.91	1.1	1.2	—	54°	55°
D2	DC25	1.0	—	0.37	0.51	0.62	0.71	0.79	0.86	1.1	1.3	1.5	32°	61°	61°
D3	DC25	1.2	0.39	0.45	0.63	0.75	0.86	0.95	1.0	1.3	1.6	1.8	47°	69°	69°
D4	DC25	1.6	0.57	0.68	0.94	1.1	1.3	1.4	1.6	2.0	2.4	2.8	63°	82°	82°
D5	DC25	2.0	0.64	0.81	1.1	1.4	1.6	1.7	1.9	2.4	2.9	3.3	70°	85°	84°
D6	DC25	2.4	0.87	1.0	1.5	1.8	2.0	2.3	2.5	3.2	3.8	4.4	77°	89°	88°
D7	DC25	2.8	1.0	1.2	1.7	2.0	2.3	2.6	2.9	3.7	4.5	5.1	83°	92°	91°
D8	DC25	3.2	1.2	1.4	2.0	2.4	2.8	3.1	3.4	4.4	5.3	6.2	89°	96°	95°
D10	DC25	4.0	1.5	1.7	2.4	3.0	3.5	3.9	4.2	5.5	6.7	7.7	94°	102°	101°
D12	DC25	4.8	1.8	2.2	3.0	3.7	4.3	4.8	5.2	6.7	8.2	9.5	101°	111°	110°
D14	DC25	5.6	1.9	2.3	3.3	4.1	4.7	5.2	5.8	7.5	9.1	10.2	105°	113°	112°
D1	DC45	0.79	—	—	—	0.48	0.56	0.61	0.67	0.84	1.0	1.2	—	39°	40°
D1.5	DC45	0.91	—	—	0.53	0.64	0.74	0.81	0.90	1.1	1.4	1.7	—	48°	50°
D2	DC45	1.0	—	0.43	0.66	0.80	0.91	1.0	1.1	1.4	1.7	2.0	26°	58°	58°
D3	DC45	1.2	—	0.53	0.74	0.91	1.0	1.2	1.3	1.6	2.0	2.3	34°	62°	62°
D4	DC45	1.6	0.67	0.80	1.1	1.4	1.6	1.8	2.0	2.5	3.1	3.6	59°	73°	72°
D5	DC45	2.0	0.87	1.0	1.5	1.8	2.0	2.3	2.5	3.2	3.9	4.5	63°	76°	75°
D6	DC45	2.4	1.1	1.3	1.9	2.3	2.7	3.0	3.3	4.3	5.3	6.1	70°	80°	79°
D7	DC45	2.8	1.3	1.5	2.2	2.7	3.1	3.5	3.9	5.0	6.2	7.2	78°	86°	85°
D8	DC45	3.2	1.6	1.9	2.7	3.3	3.9	4.3	4.8	6.2	7.6	8.9	84°	89°	88°
D10	DC45	4.0	2.0	2.5	3.5	4.4	5.0	5.6	6.2	8.0	9.8	11.5	88°	92°	91°
D12	DC45	4.8	2.5	3.1	4.4	5.3	6.2	6.9	7.6	9.8	12.1	14.0	95°	101°	100°
D14	DC45	5.6	2.8	3.4	4.9	6.0	7.0	7.8	8.6	11.2	13.6	15.9	99°	104°	103°
D16	DC45	6.4	3.3	4.0	5.7	7.1	8.2	9.3	10.2	13.2	16.3	19.1	106°	111°	110°
D1	DC46	0.79	—	—	—	0.58	0.66	0.74	0.81	1.0	1.3	1.5	—	17°	17°
D1.5	DC46	0.91	—	—	—	0.84	0.97	1.1	1.2	1.5	1.8	2.1	—	18°	18°
D2	DC46	1.0	—	—	0.89	1.1	1.2	1.3	1.5	1.9	2.2	2.5	—	20°	18°
D3	DC46	1.2	—	—	1.0	1.3	1.5	1.6	1.8	2.3	2.8	3.2	—	23°	21°
D4	DC46	1.6	1.1	1.3	1.8	2.2	2.5	2.8	3.2	4.0	4.9	5.7	20°	32°	31°
D5	DC46	2.0	1.4	1.7	2.5	3.0	3.5	3.9	4.3	5.6	6.8	7.9	28°	41°	40°
D6	DC46	2.4	2.1	2.5	3.6	4.4	5.0	5.7	6.2	8.0	9.8	11.4	38°	49°	47°
D7	DC46	2.8	—	—	4.5	5.5	6.3	7.1	7.8	10.0	12.3	13.8	—	55°	53°
D8	DC46	3.2	—	—	5.9	7.2	8.3	9.3	10.2	13.2	16.3	18.8	—	61°	59°
D10	DC46	4.0	—	—	7.9	9.7	11.3	12.6	13.8	17.9	22	25	—	66°	64°

**Note:** Always double check your application rates. Tabulations are based on spraying water at 21°C. See technical information (pages 179–202) for useful formulas and other technical information. **Strainer Note:** For nozzles using orifice disc numbers 1, 1.5 and 2, or core numbers 31 and 33, slotted strainer number 4514-20 equivalent to 25 mesh screen size is required. For all other larger capacity discs and cores, slotted strainer number 4514-32 equivalent to 16 mesh screen size is required.



### CP11444A-\*-CE Quick TeeJet Cap

For ceramic disc and core. See pages 90–91 for ordering information.

## RECOMMENDED PRESSURE RANGE



0.7–20 bar

## MATERIALS AVAILABLE



POLYMER



HARDENED STAINLESS STEEL



STAINLESS STEEL



BRASS



CERAMIC



NYLON

## HOW TO ORDER

See page 91.

## Typical Applications



**FUNGICIDE**  
CONTACT  
**EXCELLENT**  
SYSTEMIC  
**GOOD**



**INSECTICIDE**  
CONTACT  
**EXCELLENT**  
SYSTEMIC  
**GOOD**



**FERTILIZER**  
**EXCELLENT**

## SPRAY PATTERN

Produced by Cores #31, 33, 35 and 56



## FEATURES

- Ideal for airblast sprayers.
- Produce smaller droplets for thorough coverage with contact pesticides and foliar applications.
- Available in a variety of combinations of disc and core, resulting in different rates and spray angle.
- Maximum spray pressure to 20 bar.
- Available in different material type to better suit different pressure range and pesticide formulation.
- Ceramic disc and core are more suitable for abrasive and corrosive pesticide and fertilizers.

## ORIFICE DISCS

Available in a variety of sizes and materials. Ceramic for increased wear life, hardened stainless steel, stainless steel and polymer.

### Ceramic Sizes Available

DCER-2 through DCER-8, DCER-10



Ceramic



Hardened  
Stainless Steel



Stainless  
Steel



Polymer

## CORES

Standard cores are made of brass. Also available in ceramic, hardened stainless steel and Nylon. All cores with the exception of ceramic are made with rear "nibs". Make sure core is always placed with the nib facing the nozzle body.

### Ceramic Sizes Available

DC13-CER, DC23-CER, DC25-CER, DC31-CER, DC33-CER, DC35-CER, DC45-CER, DC46-CER, DC56-CER



Ceramic



Hardened  
Stainless Steel



Brass



Nylon



CP18999

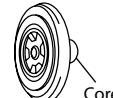

Seal





DISC	CORE	DISC DIA. (mm)	CAPACITY (l/min)										ANGLE		
			0.7 bar	1 bar	2 bar	3 bar	4 bar	5 bar	6 bar	10 bar	15 bar	20 bar	1 bar	10 bar	20 bar
D1	DC31	0.79	0.31	0.36	0.49	0.59	0.67	0.74	0.80	1.0	1.2	1.4	42°	40°	38°
D1.5	DC31	0.91	0.39	0.45	0.63	0.76	0.86	0.95	1.0	1.3	1.6	1.8	54°	46°	40°
D2	DC31	1.0	0.45	0.53	0.72	0.86	0.98	1.1	1.2	1.5	1.8	2.0	56°	54°	49°
D3	DC31	1.2	0.49	0.58	0.80	0.95	1.1	1.2	1.3	1.6	1.9	2.2	58°	67°	58°
D1	DC33	0.79	0.32	0.36	0.46	0.56	0.64	0.71	0.78	0.98	1.2	1.4	24°	37°	37°
D1.5	DC33	0.91	0.42	0.47	0.63	0.75	0.85	0.95	1.0	1.3	1.6	1.9	34°	46°	45°
D2	DC33	1.0	0.47	0.56	0.78	0.95	1.1	1.2	1.3	1.7	2.0	2.3	42°	55°	52°
D3	DC33	1.2	0.57	0.68	0.95	1.1	1.3	1.5	1.6	2.0	2.5	2.8	46°	57°	56°
D4	DC33	1.6	0.78	0.91	1.3	1.5	1.7	1.9	2.1	2.7	3.3	3.7	49°	63°	63°
D1	DC35	0.79	0.30	0.36	0.48	0.58	0.65	0.71	0.78	0.97	1.2	1.3	16°	27°	27°
D1.5	DC35	0.91	0.41	0.47	0.63	0.76	0.85	0.94	1.0	1.3	1.5	1.7	19°	30°	30°
D2	DC35	1.0	0.53	0.62	0.83	0.99	1.1	1.2	1.3	1.7	2.0	2.2	38°	45°	40°
D3	DC35	1.2	0.58	0.72	0.98	1.2	1.3	1.5	1.6	2.0	2.4	2.8	42°	48°	42°
D4	DC35	1.6	1.0	1.2	1.6	2.0	2.3	2.5	2.8	3.5	4.2	4.8	65°	68°	60°
D5	DC35	2.0	1.3	1.6	2.2	2.6	3.0	3.3	3.6	4.5	5.5	6.3	65°	69°	62°
D2	DC56	1.0	—	—	0.80	0.98	1.1	1.2	1.4	1.8	2.2	2.5	—	18°	16°
D3	DC56	1.2	—	—	1.1	1.3	1.6	1.7	1.9	2.4	3.0	3.4	—	24°	22°
D4	DC56	1.6	—	1.3	1.8	2.2	2.5	2.8	3.1	4.0	4.8	5.6	18°	30°	28°
D5	DC56	2.0	1.4	1.8	2.5	3.0	3.5	3.9	4.3	5.5	6.7	7.8	24°	35°	33°
D6	DC56	2.4	2.2	2.7	3.7	4.5	5.3	5.9	6.5	8.5	10.2	11.9	31°	40°	38°
D7	DC56	2.8	2.9	3.4	4.9	6.0	6.9	7.7	8.5	11.0	13.5	15.6	42°	53°	51°
D8	DC56	3.2	3.7	4.4	6.2	7.6	8.8	9.8	10.8	13.9	17.0	19.6	48°	58°	56°
D10	DC56	4.0	5.1	6.1	8.6	10.6	12.2	13.6	15.0	19.3	24	27	57°	66°	64°

**Note:** Always double check your application rates. Tabulations are based on spraying water at 21°C. See technical information (pages 179–202) for useful formulas and other technical information.

## RECOMMENDED PRESSURE RANGE



0.7–20 bar

## MATERIALS AVAILABLE



STAINLESS STEEL



POLYMER



HARDENED STAINLESS STEEL



STAINLESS STEEL



BRASS



CERAMIC



NYLON

For proper assembly and performance, disc and core must both be of like materials. To order orifice Disc, specify Disc number and material.

Ceramic	Hardened Stainless Steel	Stainless Steel	Polymer
D C E R - 2	D 2	D E - 2	D V P - 2

To order core, specify core number and material.

Ceramic	Hardened Stainless Steel	Brass
D C 1 3 - C E R	D C 1 3 - H S S	D C 1 3

Nylon  
D C 1 3 - N Y

Seal Gasket  
C P 1 8 9 9 9 - E P R

**Strainer Note:** For nozzles using orifice disc numbers 1, 1.5 and 2; or core numbers 31 and 33, slotted strainer number 4514-20 equivalent to 25 mesh screen size is required. For all other larger capacity discs and cores, slotted strainer number 4514-32 equivalent to 16 mesh screen size is required.

## Typical Applications



**FERTILIZER  
BROADCAST  
EXCELLENT**



**DRIFT  
CONTROL  
EXCELLENT**



## FEATURES

- Excellent for application of liquid fertilizer on bare ground or in standing crop.
- Three-stream pattern is ideal for directed application.
- Three solid streams of equal velocity and capacity.
- Offered in a variety of sizes for a wide range of application rates.
- VisiFlo® color-coding for easy capacity identification.
- All acetal construction for excellent chemical resistance.
- Solid stream pattern minimizes leaf burn and virtually eliminates drift.
- Equally spaced distribution at 50 cm height.
- Use with Quick TeeJet® 114443A\*-CEL R cap and gasket.

## SPRAY PATTERN

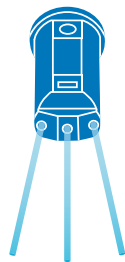

## OPTIMUM SPACING AND SPRAY HEIGHT

HEIGHT	SPACING
50 cm	50 cm
75 cm	75 cm
100 cm	100 cm

## RECOMMENDED PRESSURE RANGE



1.5–4 bar

## MATERIALS AVAILABLE



POLYMER

## HOW TO ORDER

Polymer with VisiFlo color-coding

**S J 3 - 0 3 - V P**

Tip  
Type

Capacity  
Size

Material  
Code

TIP PART NO. (STRAINER MESH SIZE)	 bar	CAPACITY ONE TIP IN l/min	APPLICATION RATE FOR 50 cm SPRAY TIP SPACING									
			l/ha									
			4 km/h	6 km/h	8 km/h	10 km/h	12 km/h	16 km/h	20 km/h	25 km/h	30 km/h	35 km/h
SJ3-015-VP (100)	1.5	0.44	132	88.0	66.0	52.8	44.0	33.0	26.4	21.1	17.6	15.1
	2.0	0.50	150	100	75.0	60.0	50.0	37.5	30.0	24.0	20.0	17.1
	2.5	0.54	162	108	81.0	64.8	54.0	40.5	32.4	25.9	21.6	18.5
	3.0	0.58	174	116	87.0	69.6	58.0	43.5	34.8	27.8	23.2	19.9
SJ3-02-VP (50)	4.0	0.65	195	130	97.5	78.0	65.0	48.8	39.0	31.2	26.0	22.3
	1.5	0.57	171	114	85.5	68.4	57.0	42.8	34.2	27.4	22.8	19.5
	2.0	0.64	192	128	96.0	76.8	64.0	48.0	38.4	30.7	25.6	21.9
	2.5	0.70	210	140	105	84.0	70.0	52.5	42.0	33.6	28.0	24.0
SJ3-03-VP (50)	3.0	0.78	234	156	117	93.6	78.0	58.5	46.8	37.4	31.2	26.7
	4.0	0.85	255	170	128	102	85.0	63.8	51.0	40.8	34.0	29.1
	1.5	0.91	273	182	137	109	91.0	68.3	54.6	43.7	36.4	31.2
	2.0	1.01	303	202	152	121	101	75.8	60.6	48.5	40.4	34.6
SJ3-04-VP (50)	2.5	1.10	330	220	165	132	110	82.5	66.0	52.8	44.0	37.7
	3.0	1.18	354	236	177	142	118	88.5	70.8	56.6	47.2	40.5
	4.0	1.31	393	262	197	157	131	98.3	78.6	62.9	52.4	44.9
	1.5	1.17	351	234	176	140	117	87.8	70.2	56.2	46.8	40.1
SJ3-05-VP (50)	2.0	1.32	396	264	198	158	132	99.0	79.2	63.4	52.8	45.3
	2.5	1.45	435	290	218	174	145	109	87.0	69.6	58.0	49.7
	3.0	1.56	468	312	234	187	156	117	93.6	74.9	62.4	53.5
	4.0	1.75	525	350	263	210	175	131	105	84.0	70.0	60.0
SJ3-06-VP (50)	1.5	1.42	426	284	213	170	142	107	85.2	68.2	56.8	48.7
	2.0	1.63	489	326	245	196	163	122	97.8	78.2	65.2	55.9
	2.5	1.82	546	364	273	218	182	137	109	87.4	72.8	62.4
	3.0	1.96	588	392	294	235	196	147	118	94.1	78.4	67.2
SJ3-08-VP	4.0	2.18	654	436	327	262	218	164	131	105	87.2	74.7
	1.5	1.69	507	338	254	203	169	127	101	81.1	67.6	57.9
	2.0	1.97	591	394	296	236	197	148	118	94.6	78.8	67.5
	2.5	2.21	663	442	332	265	221	166	133	106	88.4	75.8
SJ3-10-VP	3.0	2.40	720	480	360	288	240	180	144	115	96.0	82.3
	4.0	2.63	789	526	395	316	263	197	158	126	105	90.2
	1.5	2.32	696	464	348	278	232	174	139	111	92.8	79.5
	2.0	2.74	822	548	411	329	274	206	164	132	110	93.9
SJ3-15-VP	2.5	2.94	882	588	441	353	294	221	176	141	118	101
	3.0	3.13	939	626	470	376	313	235	188	150	125	107
	4.0	3.50	1050	700	525	420	350	263	210	168	140	120
	1.5	2.73	819	546	410	328	273	205	164	131	109	93.6
SJ3-20-VP	2.0	3.30	990	660	495	396	330	248	198	158	132	113
	2.5	3.55	1065	710	533	426	355	266	213	170	142	122
	3.0	3.91	1173	782	587	469	391	293	235	188	156	134
	4.0	4.44	1332	888	666	533	444	333	266	213	178	152
SJ3-015-VP (100)	1.5	3.91	1173	782	587	469	391	293	235	188	156	134
	2.0	4.64	1392	928	696	557	464	348	278	223	186	159
	2.5	5.29	1587	1058	794	635	529	397	317	254	212	181
	3.0	5.86	1758	1172	879	703	586	440	352	281	234	201
SJ3-20-VP	4.0	6.76	2028	1352	1014	811	676	507	406	324	270	232
	1.5	5.58	1674	1116	837	670	558	419	335	268	223	191
	2.0	6.48	1944	1296	972	778	648	486	389	311	259	222
	2.5	7.31	2193	1462	1097	877	731	548	439	351	292	251
SJ3-20-VP	3.0	8.05	2415	1610	1208	966	805	604	483	386	322	276
	4.0	9.31	2793	1862	1397	1117	931	698	559	447	372	319

**Note:** Always double check your application rates. Tabulations are based on spraying water at 21°C. See technical information (pages 179–202) for useful formulas and other technical information.

## Typical Applications



**FERTILIZER  
BROADCAST  
EXCELLENT**



**DRIFT  
CONTROL  
EXCELLENT**



## FEATURES

- The SJ3-VR line of variable rate fertilizer spray tips feature a variable diameter orifice that produces a wide range of flow rates—it's like having five tips in one.
- Allows for a wider range of ground speeds and/or application rates from a single tip for improved productivity.
- Are also ideal for variable rate prescription map applications.
- SJ3-VR tip produces three identical fluid streams for excellent distribution quality in directed applications.
- Solid stream pattern minimizes leaf burn and virtually eliminates drift.
- Acetal body and deflector plate construction for good wear life and chemical resistance.
- Simple, elastomer (EPDM) variable orifice for reliable operation.
- SJ3-VR are intended for use with flow meter based control systems only.
- Multiple capacities available for a wider range of application rates.

## SPRAY PATTERN

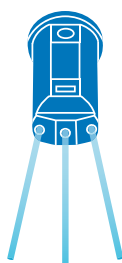

## OPTIMUM SPACING AND SPRAY HEIGHT

HEIGHT	SPACING
50 cm	50 cm
75 cm	75 cm
100 cm	100 cm

\*For best spray distribution maintain a 1:1 ratio of tip height to tip spacing.

## RECOMMENDED PRESSURE RANGE



1.5–7 bar

## MATERIALS AVAILABLE



POLYMER

## HOW TO ORDER

Polymer with VisiFlo® color-coding

S J 3 - V R - X 2 . 0

Tip  
Type

Material  
Code

Capacity  
Size

# StreamJet SJ3-VR VARIABLE RATE

FERTILIZER NOZZLES

TIP PART NO.	bar	CAPACITY ONE TIP IN l/min	APPLICATION RATE FOR 35 cm SPRAY TIP SPACING											APPLICATION RATE FOR 50 cm SPRAY TIP SPACING										
			l/ha											l/ha										
			4 km/h	6 km/h	8 km/h	10 km/h	12 km/h	16 km/h	20 km/h	25 km/h	30 km/h	35 km/h	4 km/h	6 km/h	8 km/h	10 km/h	12 km/h	16 km/h	20 km/h	25 km/h	30 km/h	35 km/h		
SJ3-VR-X0.5	1.5	0.51	219	146	109	87.4	72.9	54.6	43.7	35.0	29.1	25.0	153	102	76.5	61.2	51.0	38.3	30.6	24.5	20.4	17.5		
	2.0	0.58	249	166	124	99.4	82.9	62.1	49.7	39.8	33.1	28.4	174	116	87.0	69.6	58.0	43.5	34.8	27.8	23.2	19.9		
	2.5	0.64	274	183	137	110	91.4	68.6	54.9	43.9	36.6	31.3	192	128	96.0	76.8	64.0	48.0	38.4	30.7	25.6	21.9		
	3.0	0.71	304	203	152	122	101	76.1	60.9	48.7	40.6	34.8	213	142	107	85.2	71.0	53.3	42.6	34.1	28.4	24.3		
	3.5	0.79	339	226	169	135	113	84.6	67.7	54.2	45.1	38.7	237	158	119	94.8	79.0	59.3	47.4	37.9	31.6	27.1		
	4.0	0.87	373	249	186	149	124	93.2	74.6	59.7	49.7	42.6	261	174	131	104	87.0	65.3	52.2	41.8	34.8	29.8		
	5.0	1.06	454	303	227	182	151	114	90.9	72.7	60.6	51.9	318	212	159	127	106	79.5	63.6	50.9	42.4	36.3		
	6.0	1.28	549	366	274	219	183	137	110	87.8	73.1	62.7	384	256	192	154	128	96.0	76.8	61.4	51.2	43.9		
7.0	1.55	664	443	332	266	221	166	133	106	88.6	75.9	465	310	233	186	155	116	93.0	74.4	62.0	53.1			
SJ3-VR-X1.0	1.5	0.84	360	240	180	144	120	90.0	72.0	57.6	48.0	41.1	252	168	126	101	84.0	63.0	50.4	40.3	33.6	28.8		
	2.0	1.02	437	291	219	175	146	109	87.4	69.9	58.3	50.0	306	204	153	122	102	76.5	61.2	49.0	40.8	35.0		
	2.5	1.21	519	346	259	207	173	130	104	83.0	69.1	59.3	363	242	182	145	121	90.8	72.6	58.1	48.4	41.5		
	3.0	1.41	604	403	302	242	201	151	121	96.7	80.6	69.1	423	282	212	169	141	106	84.6	67.7	56.4	48.3		
	3.5	1.62	694	463	347	278	231	174	139	111	92.6	79.3	486	324	243	194	162	122	97.2	77.8	64.8	55.5		
	4.0	1.84	789	526	394	315	263	197	158	126	105	90.1	552	368	276	221	184	138	110	88.3	73.6	63.1		
	5.0	2.33	999	666	499	399	333	250	200	160	133	114	699	466	350	280	233	175	140	112	93.2	79.9		
	6.0	2.86	1226	817	613	490	409	306	245	196	163	140	858	572	429	343	286	215	172	137	114	98.1		
7.0	3.44	1474	983	737	590	491	369	295	236	197	168	1032	688	516	413	344	258	206	165	138	118			
SJ3-VR-X2.0	1.5	2.19	939	626	469	375	313	235	188	150	125	107	657	438	329	263	219	164	131	105	87.6	75.1		
	2.0	2.58	1106	737	553	442	369	276	221	177	147	126	774	516	387	310	258	194	155	124	103	88.5		
	2.5	2.97	1273	849	636	509	424	318	255	204	170	145	891	594	446	356	297	223	178	143	119	102		
	3.0	3.36	1440	960	720	576	480	360	288	230	192	165	1008	672	504	403	336	252	202	161	134	115		
	3.5	3.74	1603	1069	801	641	534	401	321	256	214	183	1122	748	561	449	374	281	224	180	150	128		
	4.0	4.11	1761	1174	881	705	587	440	352	282	235	201	1233	822	617	493	411	308	247	197	164	141		
	5.0	7.85	3364	2243	1682	1346	1121	841	673	538	449	384	2355	1570	1178	942	785	589	471	377	314	269		
	6.0	5.58	2391	1594	1196	957	797	598	478	383	319	273	1674	1116	837	670	558	419	335	268	223	191		
7.0	6.29	2696	1797	1348	1078	899	674	539	431	359	308	1887	1258	944	755	629	472	377	302	252	216			

**Note:** Always double check your application rates. Tabulations are based on spraying water at 21°C. See technical information (pages 179–202) for useful formulas and other technical information.

## SPEED RANGE FOR VARIOUS APPLICATION RATES

TIP PART NO.	GROUND SPEED RANGE (km/h) FOR 35 cm SPACING																GROUND SPEED RANGE (km/h) FOR 50 cm SPACING															
	100 l/ha		200 l/ha		300 l/ha		400 l/ha		500 l/ha		600 l/ha		700 l/ha		800 l/ha		100 l/ha		200 l/ha		300 l/ha		400 l/ha		500 l/ha		600 l/ha		700 l/ha		800 l/ha	
	MIN	MAX	MIN	MAX	MIN	MAX	MIN	MAX	MIN	MAX	MIN	MAX	MIN	MAX	MIN	MAX	MIN	MAX	MIN	MAX	MIN	MAX	MIN	MAX	MIN	MAX	MIN	MAX	MIN	MAX	MIN	MAX
SJ3-VR-X0.5	8.7	27	4.4	13.3	2.9	8.9	2.2	6.6	1.7	5.3	1.5	4.4	1.2	3.8	1.1	3.3	6.1	19	3.1	9.3	2.0	6.2	1.5	4.7	1.2	3.7	1.0	3.1	0.9	2.7	0.8	2.3
SJ3-VR-X1.0	14.4	59*	7.2	29	4.8	20	3.6	15	2.9	11.8	2.4	9.8	2.1	8.4	1.8	7.4	10.1	41*	5.0	21	3.4	14	2.5	10	2.0	8.3	1.7	6.9	1.4	5.9	1.3	5.2
SJ3-VR-X2.0	-	-	19	54*	12.5	36*	9.4	27	7.5	22	6.3	18	5.4	15	4.7	13.5	-	-	13	37*	8.8	25	6.6	19	5.3	15	4.4	13	3.8	11	3.3	9.4

\*For safest application, recommended maximum speed is 35 km/h.



## Typical Applications



**FERTILIZER  
BROADCAST  
EXCELLENT**



**DRIFT  
CONTROL  
EXCELLENT**



## FEATURES

- Excellent for application of liquid fertilizer on bare ground or in standing crop.
- Seven-stream pattern is ideal for broadcast application.
- Creates seven identical fluid streams of equal velocity and capacity.
- Excellent spray distribution quality.
- Removable metering orifice for easy cleaning.
- Offered in a variety of sizes for a wide range of application rates.
- VisiFlo® color-coding for easy capacity identification.
- All acetal construction for excellent chemical resistance.
- Solid stream pattern minimizes leaf burn and virtually eliminates drift.
- SJ7A spray tip molded into Quick TeeJet® cap.

## SPRAY PATTERN



## OPTIMUM SPACING AND SPRAY HEIGHT

HEIGHT	SPACING
50 cm	50 cm
75 cm	75 cm
100 cm	100 cm

## RECOMMENDED PRESSURE RANGE



## MATERIALS AVAILABLE



## HOW TO ORDER

Polymer with VisiFlo color-coding

**S J 7 A - 0 4 - V P**

Tip  
Type

Capacity  
Size

Material  
Code



**50854-NYB**  
Extension Adapter

TIP PART NO. (STRAINER MESH SIZE)	bar	CAPACITY ONE TIP IN l/min	APPLICATION RATE FOR 50 cm SPRAY TIP SPACING									
			l/ha									
			4 km/h	6 km/h	8 km/h	10 km/h	12 km/h	16 km/h	20 km/h	25 km/h	30 km/h	35 km/h
SJ7A-015-VP (100)	1.5	0.39	117	78.0	58.5	46.8	39.0	29.3	23.4	18.7	15.6	13.4
	2.0	0.46	138	92.0	69.0	55.2	46.0	34.5	27.6	22.1	18.4	15.8
	2.5	0.52	156	104	78.0	62.4	52.0	39.0	31.2	25.0	20.8	17.8
	3.0	0.57	171	114	85.5	68.4	57.0	42.8	34.2	27.4	22.8	19.5
	4.0	0.67	201	134	101	80.4	67.0	50.3	40.2	32.2	26.8	23.0
SJ7A-02-VP (50)	1.5	0.55	165	110	82.5	66.0	55.0	41.3	33.0	26.4	22.0	18.9
	2.0	0.64	192	128	96.0	76.8	64.0	48.0	38.4	30.7	25.6	21.9
	2.5	0.72	216	144	108	86.4	72.0	54.0	43.2	34.6	28.8	24.7
	3.0	0.80	240	160	120	96.0	80.0	60.0	48.0	38.4	32.0	27.4
	4.0	0.93	279	186	140	112	93.0	69.8	55.8	44.6	37.2	31.9
SJ7A-03-VP (50)	1.5	0.87	261	174	131	104	87.0	65.3	52.2	41.8	34.8	29.8
	2.0	1.00	300	200	150	120	100	75.0	60.0	48.0	40.0	34.3
	2.5	1.10	330	220	165	132	110	82.5	66.0	52.8	44.0	37.7
	3.0	1.18	354	236	177	142	118	88.5	70.8	56.6	47.2	40.5
	4.0	1.31	393	262	197	157	131	98.3	78.6	62.9	52.4	44.9
SJ7A-04-VP (50)	1.5	1.17	351	234	176	140	117	87.8	70.2	56.2	46.8	40.1
	2.0	1.33	399	266	200	160	133	99.8	79.8	63.8	53.2	45.6
	2.5	1.45	435	290	218	174	145	109	87.0	69.6	58.0	49.7
	3.0	1.55	465	310	233	186	155	116	93.0	74.4	62.0	53.1
	4.0	1.72	516	344	258	206	172	129	103	82.6	68.8	59.0
SJ7A-05-VP (50)	1.5	1.49	447	298	224	179	149	112	89.4	71.5	59.6	51.1
	2.0	1.68	504	336	252	202	168	126	101	80.6	67.2	57.6
	2.5	1.83	549	366	275	220	183	137	110	87.8	73.2	62.7
	3.0	1.95	585	390	293	234	195	146	117	93.6	78.0	66.9
	4.0	2.16	648	432	324	259	216	162	130	104	86.4	74.1
SJ7A-06-VP (50)	1.5	1.77	531	354	266	212	177	133	106	85.0	70.8	60.7
	2.0	2.01	603	402	302	241	201	151	121	96.5	80.4	68.9
	2.5	2.19	657	438	329	263	219	164	131	105	87.6	75.1
	3.0	2.35	705	470	353	282	235	176	141	113	94.0	80.6
	4.0	2.61	783	522	392	313	261	196	157	125	104	89.5
SJ7A-08-VP	1.5	2.28	684	456	342	274	228	171	137	109	91.2	78.2
	2.0	2.66	798	532	399	319	266	200	160	128	106	91.2
	2.5	2.94	882	588	441	353	294	221	176	141	118	101
	3.0	3.15	945	630	473	378	315	236	189	151	126	108
	4.0	3.46	1038	692	519	415	346	260	208	166	138	119
SJ7A-10-VP	1.5	2.84	852	568	426	341	284	213	170	136	114	97.4
	2.0	3.32	996	664	498	398	332	249	199	159	133	114
	2.5	3.67	1101	734	551	440	367	275	220	176	147	126
	3.0	3.94	1182	788	591	473	394	296	236	189	158	135
	4.0	4.33	1299	866	650	520	433	325	260	208	173	148
SJ7A-15-VP	1.5	4.09	1227	818	614	491	409	307	245	196	164	140
	2.0	4.82	1446	964	723	578	482	362	289	231	193	165
	2.5	5.40	1620	1080	810	648	540	405	324	259	216	185
	3.0	5.87	1761	1174	881	704	587	440	352	282	235	201
	4.0	6.58	1974	1316	987	790	658	494	395	316	263	226

**Note:** Always double check your application rates. Tabulations are based on spraying water at 21°C. See technical information (pages 179–202) for useful formulas and other technical information.

## Typical Applications



**FERTILIZER  
BROADCAST  
EXCELLENT**



**DRIFT  
CONTROL  
EXCELLENT**



## FEATURES

- The SJ7A-VR line of variable rate fertilizer spray tips feature a variable diameter orifice that produces a wide range of flow rates—it's like having five tips in one.
- Allows for a wider range of ground speeds and/or application rates from a single tip for improved productivity.
- Also ideal for variable rate prescription map applications.
- SJ7A-VR tip produces seven identical fluid streams for excellent distribution quality in broadcast applications.
- Solid stream pattern minimizes leaf burn and virtually eliminates drift.
- Acetal body and deflector plate construction for good wear life and chemical resistance.
- Simple, elastomer (EPDM) variable orifice for reliable operation.
- SJ7A-VR are intended for use with flow meter based control systems only.
- Multiple capacities available for wider range of application rates.

## SPRAY PATTERN

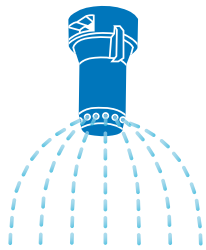

## OPTIMUM SPACING AND SPRAY HEIGHT

HEIGHT	SPACING
50 cm	50 cm
75 cm	75 cm
100 cm	100 cm

\*For best spray distribution maintain a 1:1 ratio of tip height to tip spacing.

## RECOMMENDED PRESSURE RANGE



## MATERIALS AVAILABLE



## HOW TO ORDER

Polymer with VisiFlo® color-coding

**S J 7 A - V R - X 2 . 0**

Tip  
Type

Material  
Code

Capacity  
Size

TIP PART NO.	bar	CAPACITY ONE TIP IN l/min	APPLICATION RATE FOR 50 cm SPRAY TIP SPACING										APPLICATION RATE FOR 75 cm SPRAY TIP SPACING									
			l/ha										l/ha									
			8 km/h	10 km/h	12 km/h	14 km/h	16 km/h	18 km/h	20 km/h	25 km/h	30 km/h	35 km/h	8 km/h	10 km/h	12 km/h	14 km/h	16 km/h	18 km/h	20 km/h	25 km/h	30 km/h	35 km/h
SJ7A-VR-X0.5	2.0	0.59	88.5	70.8	59.0	50.6	44.3	39.3	35.4	28.3	23.6	20.2	59.0	47.2	39.3	33.7	29.5	26.2	23.6	18.9	15.7	13.5
	2.5	0.67	100.5	80.4	67.0	57.4	50.3	44.7	40.2	32.2	26.8	23.0	67.0	53.6	44.7	38.3	33.5	29.8	26.8	21.4	17.9	15.3
	3.0	0.76	114.0	91.2	76.0	65.1	57.0	50.7	45.6	36.5	30.4	26.1	76.0	60.8	50.7	43.4	38.0	33.8	30.4	24.3	20.3	17.4
	3.5	0.85	127.5	102.0	85.0	72.9	63.8	56.7	51.0	40.8	34.0	29.1	85.0	68.0	56.7	48.6	42.5	37.8	34.0	27.2	22.7	19.4
	4.5	1.07	160.5	128.4	107.0	91.7	80.3	71.3	64.2	51.4	42.8	36.7	107.0	85.6	71.3	61.1	53.5	47.6	42.8	34.2	28.5	24.5
	5.5	1.33	199.5	159.6	133.0	114.0	99.8	88.7	79.8	63.8	53.2	45.6	133.0	106.4	88.7	76.0	66.5	59.1	53.2	42.6	35.5	30.4
SJ7A-VR-X1.0	2.0	1.01	152	121	101	86.6	75.8	67.3	60.6	48.5	40.4	34.6	101	80.8	67.3	57.7	50.5	44.9	40.4	32.3	26.9	23.1
	2.5	1.20	180	144	120	103	90.0	80.0	72.0	57.6	48.0	41.1	120	96.0	80.0	68.6	60.0	53.3	48.0	38.4	32.0	27.4
	3.0	1.42	213	170	142	122	107	94.7	85.2	68.2	56.8	48.7	142	114	94.7	81.1	71.0	63.1	56.8	45.4	37.9	32.5
	3.5	1.67	251	200	167	143	125	111	100	80.2	66.8	57.3	167	134	111	95.4	83.5	74.2	66.8	53.4	44.5	38.2
	4.5	2.25	338	270	225	193	169	150	135	108	90.0	77.1	225	180	150	129	113	100	90.0	72.0	60.0	51.4
	5.5	2.94	441	353	294	252	221	196	176	141	118	101	294	235	196	168	147	131	118	94.1	78.4	67.2
SJ7A-VR-X2.0	2.0	2.62	393	314	262	225	197	175	157	126	105	89.8	262	210	175	150	131	116	105	83.8	69.9	59.9
	2.5	3.00	450	360	300	257	225	200	180	144	120	103	300	240	200	171	150	133	120	96.0	80.0	68.6
	3.0	3.42	513	410	342	293	257	228	205	164	137	117	342	274	228	195	171	152	137	109	91.2	78.2
	3.5	3.87	581	464	387	332	290	258	232	186	155	133	387	310	258	221	194	172	155	124	103	88.5
	4.5	4.84	726	581	484	415	363	323	290	232	194	166	484	387	323	277	242	215	194	155	129	111
	5.5	5.92	888	710	592	507	444	395	355	284	237	203	592	474	395	338	296	263	237	189	158	135

**Note:** Always double check your application rates. Tabulations are based on spraying water at 21°C. See technical information (pages 179–202) for useful formulas and other technical information.

### SPEED RANGE FOR VARIOUS APPLICATION RATES

TIP PART NO.	GROUND SPEED RANGE (km/h) FOR 50 cm SPACING																GROUND SPEED RANGE (km/h) FOR 75 cm SPACING															
	100 l/ha		200 l/ha		300 l/ha		400 l/ha		500 l/ha		600 l/ha		700 l/ha		800 l/ha		100 l/ha		200 l/ha		300 l/ha		400 l/ha		500 l/ha		600 l/ha		700 l/ha		800 l/ha	
	MIN	MAX	MIN	MAX	MIN	MAX	MIN	MAX	MIN	MAX	MIN	MAX	MIN	MAX	MIN	MAX	MIN	MAX	MIN	MAX	MIN	MAX	MIN	MAX	MIN	MAX	MIN	MAX	MIN	MAX	MIN	MAX
SJ7A-VR-X0.5	7.1	16	3.5	8.0	2.4	5.3	1.8	4.0	1.4	3.2	1.2	2.7	1.0	2.3	0.9	2.0	4.7	11	2.4	5.3	1.6	3.5	1.2	2.7	0.9	2.1	0.8	1.8	0.7	1.5	0.6	1.3
SJ7A-VR-X1.0	12	35	6.1	18	4.0	12	3.0	8.8	2.4	7.1	2.0	5.9	1.7	5.0	1.5	4.4	8.1	24	4.0	12	2.7	7.8	2.0	5.9	1.6	4.7	1.3	3.9	1.2	3.4	1.0	2.9
SJ7A-VR-X2.0	-	-	16	36*	10	24	7.9	18	6.3	14	5.2	12	4.5	10	3.9	8.9	-	-	10	24	7.0	16	5.2	12	4.2	9.5	3.5	7.9	3.0	6.8	2.6	5.9

\*For safest application, recommended maximum speed is 35 km/h.

## Typical Applications



**FERTILIZER  
BROADCAST  
EXCELLENT**



**DRIFT  
CONTROL  
EXCELLENT**



QJ-VR Hose Barb  
Metering Assembly



QJ-VR Metering Assembly



PTC-VR Push-to-Connect  
Metering Assembly

## FEATURES

- The QJ-VR and PTC-VR line of variable rate fertilizer assemblies feature a variable diameter orifice that produces a wide range of flow rates—its like having several metering orifices in one.
- Allows for a wider range of ground speeds and/or application rates from a single size for improved productivity.
- Also ideal for variable rate prescription map applications.
- Both QJ-VR and PTC-VR are ideal for installation on planters and toolbars for liquid fertilizer metering and application.
- PTC-VR features nylon construction for excellent strength and chemical resistance.
- QJ-VR features acetal and nylon construction with choice of nylon or stainless steel hose barbs for strength and excellent chemical resistance.
- Simple, elastomer (EPDM) variable orifice for reliable, long-term operation.

## SPRAY PATTERN



## SIZE OPTIONS

TIP PART NO.	HOSE SIZE (I.D.)				TUBING SIZE (O.D.)		
	¼"	⅝"	¾"	½"	¼"	⅝"	¾"
QJ-VR-X0.5	•	•	•				
QJ-VR-X1.0	•	•	•				
QJ-VR-X2.0			•	•			
PTC-VR-X0.5					•	•	•
PTC-VR-X1.0					•	•	•
PTC-VR-X2.0						•	•

**Note:** ¼" and ⅝" hose barb sizes offered in stainless steel only. ¾" and ½" hose barbs offered in choice of stainless steel or nylon.

## RECOMMENDED PRESSURE RANGE



## MATERIALS AVAILABLE



## HOW TO ORDER

Quick TeeJet® Variable Rate Metering Assembly  
(no Hose Barb)

Q J - V R - X 2 . 0

¾" Push-to-Connect Variable Rate  
Metering Assembly

P T C - V R - X 1 . 0 - 3 / 8

¼" Stainless Steel Hose Barb Variable Rate  
Metering Assembly

Q J - V R - X 1 . 0 - 1 / 4 - S S

¼" Push-to-Connect Variable Rate Metering Assembly  
with 0.7 bar Diaphragm Check Valve

P T C - V R - X 1 . 0 - 1 / 4 - 1 0

TIP PART NO.	CAPACITY ONE TIP IN l/min	APPLICATION RATE FOR 50 cm SPRAY TIP SPACING											APPLICATION RATE FOR 75 cm SPRAY TIP SPACING										
		l/ha											l/ha										
		4 km/h	6 km/h	8 km/h	10 km/h	12 km/h	16 km/h	20 km/h	25 km/h	30 km/h	35 km/h	4 km/h	6 km/h	8 km/h	10 km/h	12 km/h	16 km/h	20 km/h	25 km/h	30 km/h	35 km/h		
QJ-VR-X0.5 PTC-VR-X0.5	1.0	0.41	123	82.0	61.5	49.2	41.0	30.8	24.6	19.7	16.4	14.1	82.0	54.7	41.0	32.8	27.3	20.5	16.4	13.1	10.9	9.4	
	1.5	0.51	153	102	76.5	61.2	51.0	38.3	30.6	24.5	20.4	17.5	102	68.0	51.0	40.8	34.0	25.5	20.4	16.3	13.6	11.7	
	2.0	0.63	189	126	94.5	75.6	63.0	47.3	37.8	30.2	25.2	21.6	126	84.0	63.0	50.4	42.0	31.5	25.2	20.2	16.8	14.4	
	2.5	0.71	213	142	107	85.2	71.0	53.3	42.6	34.1	28.4	24.3	142	94.7	71.0	56.8	47.3	35.5	28.4	22.7	18.9	16.2	
	3.0	0.81	243	162	122	97.2	81.0	60.8	48.6	38.9	32.4	27.8	162	108	81.0	64.8	54.0	40.5	32.4	25.9	21.6	18.5	
	3.5	0.92	276	184	138	110	92.0	69.0	55.2	44.2	36.8	31.5	184	123	92.0	73.6	61.3	46.0	36.8	29.4	24.5	21.0	
	4.0	1.03	309	206	155	124	103	77.3	61.8	49.4	41.2	35.3	206	137	103	82.4	68.7	51.5	41.2	33.0	27.5	23.5	
	5.0	1.28	384	256	192	154	128	96.0	76.8	61.4	51.2	43.9	256	171	128	102	85.3	64.0	51.2	41.0	34.1	29.3	
	6.0	1.58	474	316	237	190	158	119	94.8	75.8	63.2	54.2	316	211	158	126	105	79.0	63.2	50.6	42.1	36.1	
7.0	1.96	588	392	294	235	196	147	118	94.1	78.4	67.2	392	261	196	157	131	98.0	78.4	62.7	52.3	44.8		
QJ-VR-X1.0 PTC-VR-X1.0	1.0	0.62	186	124	93.0	74.4	62.0	46.5	37.2	29.8	24.8	21.3	124	82.7	62.0	49.6	41.3	31.0	24.8	19.8	16.5	14.2	
	1.5	0.80	240	160	120	96.0	80.0	60.0	48.0	38.4	32.0	27.4	160	107	80.0	64.0	53.3	40.0	32.0	25.6	21.3	18.3	
	2.0	1.00	300	200	150	120	100	75.0	60.0	48.0	40.0	34.3	200	133	100	80.0	66.7	50.0	40.0	32.0	26.7	22.9	
	2.5	1.22	366	244	183	146	122	91.5	73.2	58.6	48.8	41.8	244	163	122	97.6	81.3	61.0	48.8	39.0	32.5	27.9	
	3.0	1.46	438	292	219	175	146	110	87.6	70.1	58.4	50.1	292	195	146	117	97.3	73.0	58.4	46.7	38.9	33.4	
	3.5	1.72	516	344	258	206	172	129	103	82.6	68.8	59.0	344	229	172	138	115	86.0	68.8	55.0	45.9	39.3	
	4.0	2.00	600	400	300	240	200	150	120	96.0	80.0	68.6	400	267	200	160	133	100	80.0	64.0	53.3	45.7	
	5.0	2.61	783	522	392	313	261	196	157	125	104	89.5	522	348	261	209	174	131	104	83.5	69.6	59.7	
	6.0	3.31	993	662	497	397	331	248	199	159	132	113	662	441	331	265	221	166	132	106	88.3	75.7	
7.0	4.08	1224	816	612	490	408	306	245	196	163	140	816	544	408	326	272	204	163	131	109	93.3		
QJ-VR-X2.0 PTC-VR-X2.0	1.0	1.78	534	356	267	214	178	134	107	85.4	71.2	61.0	356	237	178	142	119	89.0	71.2	57.0	47.5	40.7	
	1.5	2.17	651	434	326	260	217	163	130	104	86.8	74.4	434	289	217	174	145	109	86.8	69.4	57.9	49.6	
	2.0	2.58	774	516	387	310	258	194	155	124	103	88.5	516	344	258	206	172	129	103	82.6	68.8	59.0	
	2.5	3.01	903	602	452	361	301	226	181	144	120	103	602	401	301	241	201	151	120	96.3	80.3	68.8	
	3.0	3.45	1035	690	518	414	345	259	207	166	138	118	690	460	345	276	230	173	138	110	92.0	78.9	
	3.5	3.92	1176	784	588	470	392	294	235	188	157	134	784	523	392	314	261	196	157	125	105	89.6	
	4.0	4.41	1323	882	662	529	441	331	265	212	176	151	882	588	441	353	294	221	176	141	118	101	
	5.0	5.44	1632	1088	816	653	544	408	326	261	218	187	1088	725	544	435	363	272	218	174	145	124	
	6.0	6.55	1965	1310	983	786	655	491	393	314	262	225	1310	873	655	524	437	328	262	210	175	150	
7.0	7.75	2325	1550	1163	930	775	581	465	372	310	266	1550	1033	775	620	517	388	310	248	207	177		

**Note:** Always double check your application rates. Tabulations are based on spraying water at 21°C. See technical information (pages 179–202) for useful formulas and other technical information.

## SPEED RANGE FOR VARIOUS APPLICATION RATES

TIP PART NO.	GROUND SPEED RANGE (km/h) FOR 50 cm SPACING																GROUND SPEED RANGE (km/h) FOR 75 cm SPACING															
	100 l/ha		200 l/ha		300 l/ha		400 l/ha		500 l/ha		600 l/ha		700 l/ha		800 l/ha		100 l/ha		200 l/ha		300 l/ha		400 l/ha		500 l/ha		600 l/ha		700 l/ha		800 l/ha	
	MIN	MAX	MIN	MAX	MIN	MAX	MIN	MAX	MIN	MAX	MIN	MAX	MIN	MAX	MIN	MAX	MIN	MAX	MIN	MAX	MIN	MAX	MIN	MAX	MIN	MAX	MIN	MAX	MIN	MAX	MIN	MAX
QJ-VR-X0.5 PTC-VR-X0.5	4.9	24	2.5	12	1.6	8	1.2	5.9	1.0	4.7	0.8	3.9	0.7	3.4	0.6	2.9	3.3	16	1.6	7.8	1.1	5.2	0.8	3.9	0.7	3.1	0.5	2.6	0.5	2.2	0.4	2.0
QJ-VR-X1.0 PTC-VR-X1.0	7.4	49*	3.7	24	2.5	16	1.9	12	1.5	10	1.2	8.2	1.1	7.0	0.9	6.1	5.0	33	2.5	16	1.7	11	1.2	8.2	1.0	6.5	0.8	5.4	0.7	4.7	0.6	4.1
QJ-VR-X2.0 PTC-VR-X2.0	21.4	93*	11	47*	7.1	31	5.3	23	4.3	19	3.6	16	3.1	13	2.7	12	14	62*	7.1	31	4.7	21	3.6	16	2.8	12	2.4	10	2.0	8.9	1.8	7.8

\*For safest application, recommended maximum speed is 35 km/h.



## Typical Applications



**FERTILIZER**  
DIRECTED  
**EXCELLENT**

Flow Regulators are usually mounted behind cultivator shanks for the subsurface application of liquid fertilizers and soil fumigants. They are also used for above-ground streaming applications.



**CP1322**  
1/4TT Body



**5053**  
Strainer



**CP4916**  
Orifice Plate



**CP4928**  
Adapter 1/8" NPT (F)  
Outlet



**CP1325**  
Cap



**Note:** Always insert orifice plate with side marked with number facing the outlet.  
MATERIAL: Stainless Steel

## TIP STRAINER MESH RECOMMENDATION

FOR ORIFICE SIZE	USE MESH SIZE
15 and Smaller	200
16–39	100
40–70	50
72 and Larger	—

To determine the orifice plates you need, use the following equations:

$$l/\text{ha (Per Nozzle)} = \frac{l/\text{ha} \times l/\text{min} \times W}{60,000}$$

$$l/\text{ha} = \frac{60,000 \times l/\text{min (Per Nozzle)}}{\text{km/h} \times W}$$

Tabulated flow rates are for spraying water into air at atmospheric pressure. If your application creates backpressure, or if spraying into a liquid, measure and calibrate to ensure proper application rates. For spraying solutions other than water, see page 185 for conversion factors.

- W = Nozzle spacing (in cm) for broadcast spraying.
- = Spray width (in cm) for single nozzle, band spraying or boomless spraying.
- = Row spacing (in cm) divided by the number of nozzles per row for directed spraying.

ORIFICE PLATE PART NO.	CAPACITY (l/min)						
	0.5 bar	1 bar	1.5 bar	2 bar	2.5 bar	3 bar	4 bar
CP4916-008	0.013	0.018	0.023	0.026	0.029	0.032	0.037
CP4916-10	0.021	0.029	0.036	0.042	0.047	0.051	0.059
CP4916-12	0.031	0.043	0.053	0.061	0.068	0.075	0.087
CP4916-14	0.040	0.057	0.070	0.081	0.090	0.099	0.11
CP4916-15	0.045	0.064	0.078	0.090	0.10	0.11	0.13
CP4916-16	0.053	0.075	0.092	0.11	0.12	0.13	0.15
CP4916-18	0.069	0.098	0.12	0.14	0.16	0.17	0.20
CP4916-20	0.086	0.12	0.15	0.17	0.19	0.21	0.24
CP4916-22	0.098	0.14	0.17	0.20	0.22	0.24	0.28
CP4916-24	0.12	0.17	0.21	0.24	0.27	0.29	0.34
CP4916-25	0.13	0.18	0.22	0.25	0.28	0.31	0.36
CP4916-26	0.14	0.20	0.24	0.28	0.31	0.34	0.39
CP4916-27	0.15	0.21	0.26	0.29	0.33	0.36	0.42
CP4916-28	0.16	0.23	0.28	0.32	0.36	0.39	0.45
CP4916-29	0.18	0.25	0.30	0.35	0.39	0.43	0.50
CP4916-30	0.18	0.26	0.32	0.37	0.41	0.45	0.52
CP4916-31	0.20	0.28	0.35	0.40	0.45	0.49	0.57
CP4916-32	0.22	0.31	0.38	0.43	0.48	0.53	0.61
CP4916-34	0.24	0.34	0.41	0.47	0.53	0.58	0.67
CP4916-35	0.25	0.36	0.44	0.51	0.57	0.62	0.72
CP4916-37	0.28	0.39	0.48	0.56	0.62	0.68	0.79
CP4916-39	0.31	0.43	0.53	0.61	0.69	0.75	0.87
CP4916-40	0.33	0.47	0.57	0.66	0.74	0.81	0.94
CP4916-41	0.34	0.48	0.59	0.68	0.76	0.83	0.96
CP4916-43	0.37	0.53	0.64	0.74	0.83	0.91	1.05
CP4916-45	0.40	0.57	0.70	0.81	0.90	0.99	1.14
CP4916-46	0.44	0.62	0.76	0.87	0.98	1.07	1.24

**Note:** Always double check your application rates. Tabulations are based on spraying water at 21°C. See technical information (pages 179–202) for useful formulas and other technical information.

ORIFICE PLATE PART NO.	CAPACITY (l/min)						
	0.5 bar	1 bar	1.5 bar	2 bar	2.5 bar	3 bar	4 bar
CP4916-47	0.45	0.63	0.77	0.89	1.00	1.09	1.26
CP4916-48	0.46	0.65	0.80	0.92	1.03	1.13	1.31
CP4916-49	0.47	0.67	0.82	0.95	1.06	1.16	1.34
CP4916-51	0.53	0.75	0.92	1.06	1.19	1.30	1.50
CP4916-52	0.54	0.76	0.93	1.08	1.21	1.32	1.52
CP4916-54	0.58	0.82	1.00	1.16	1.30	1.42	1.64
CP4916-55	0.61	0.86	1.05	1.22	1.36	1.49	1.72
CP4916-57	0.65	0.91	1.12	1.29	1.44	1.58	1.82
CP4916-59	0.70	0.99	1.21	1.40	1.56	1.71	1.98
CP4916-61	0.75	1.06	1.30	1.50	1.68	1.84	2.13
CP4916-63	0.79	1.12	1.37	1.58	1.77	1.94	2.24
CP4916-65	0.84	1.19	1.46	1.68	1.88	2.06	2.38
CP4916-67	0.89	1.26	1.55	1.79	2.00	2.19	2.53
CP4916-68	0.92	1.31	1.60	1.85	2.06	2.26	2.61
CP4916-70	0.99	1.40	1.71	1.98	2.21	2.42	2.79
CP4916-72	1.03	1.46	1.79	2.07	2.31	2.53	2.92
CP4916-73	1.07	1.51	1.85	2.13	2.38	2.61	3.01
CP4916-75	1.12	1.58	1.94	2.24	2.50	2.74	3.16
CP4916-78	1.24	1.76	2.15	2.48	2.78	3.04	3.51
CP4916-80	1.28	1.81	2.21	2.56	2.86	3.13	3.61
CP4916-81	1.32	1.87	2.29	2.65	2.96	3.24	3.74
CP4916-83	1.45	2.04	2.50	2.89	3.23	3.54	4.09
CP4916-86	1.52	2.14	2.62	3.03	3.39	3.71	4.28
CP4916-89	1.58	2.23	2.74	3.16	3.53	3.87	4.47
CP4916-91	1.68	2.38	2.91	3.36	3.76	4.12	4.76
CP4916-93	1.76	2.49	3.06	3.53	3.94	4.32	4.99
CP4916-95	1.84	2.60	3.19	3.68	4.12	4.51	5.21

ORIFICE PLATE PART NO.	CAPACITY (l/min)						
	0.5 bar	1 bar	1.5 bar	2 bar	2.5 bar	3 bar	4 bar
CP4916-98	2.01	2.85	3.49	4.03	4.50	4.93	5.69
CP4916-103	2.10	2.97	3.64	4.21	4.70	5.15	5.95
CP4916-107	2.36	3.34	4.09	4.72	5.28	5.78	6.67
CP4916-110	2.50	3.53	4.33	5.00	5.59	6.12	7.07
CP4916-115	2.76	3.90	4.77	5.51	6.16	6.75	7.79
CP4916-120	2.87	4.06	4.97	5.74	6.42	7.03	8.12
CP4916-125	3.16	4.47	5.47	6.32	7.07	7.74	8.94
CP4916-128	3.29	4.65	5.69	6.57	7.35	8.05	9.30
CP4916-132	3.53	4.99	6.11	7.06	7.89	8.64	9.98
CP4916-136	3.83	5.41	6.63	7.65	8.55	9.37	10.8
CP4916-140	4.08	5.77	7.06	8.16	9.12	9.99	11.5
CP4916-144	4.22	5.97	7.31	8.44	9.44	10.3	11.9
CP4916-147	4.34	6.14	7.52	8.69	9.71	10.6	12.3
CP4916-151	4.74	6.70	8.20	9.47	10.6	11.6	13.4
CP4916-156	5.01	7.08	8.67	10.0	11.2	12.3	14.2
CP4916-161	5.26	7.44	9.12	10.5	11.8	12.9	14.9
CP4916-166	5.53	7.82	9.57	11.1	12.4	13.5	15.6
CP4916-170	5.94	8.40	10.3	11.9	13.3	14.6	16.8
CP4916-172	6.18	8.74	10.7	12.4	13.8	15.1	17.5
CP4916-177	6.45	9.12	11.2	12.9	14.4	15.8	18.2
CP4916-182	6.71	9.49	11.6	13.4	15.0	16.4	19.0
CP4916-187	7.11	10.1	12.3	14.2	15.9	17.4	20.1
CP4916-196	7.89	11.2	13.7	15.8	17.6	19.3	22.3
CP4916-205	8.55	12.1	14.8	17.1	19.1	20.9	24.2
CP4916-218	9.60	13.6	16.6	19.2	21.5	23.5	27.2
CP4916-234	11.2	15.8	19.4	22.4	25.0	27.4	31.6
CP4916-250	12.9	18.2	22.3	25.8	28.8	31.6	36.5

**Note:** Always double check your application rates. Tabulations are based on spraying water at 21°C. See technical information (pages 179–202) for useful formulas and other technical information.

## HOW TO ORDER

CP4916-008

Orifice Plate

Capacity Size



## Stainless Steel for Banding Fertilizers

- Permits banding fluids at high-rig speeds.
- Large orifices with no internal obstructions permit non-clogging suspension applications.
- Lower drift potential.
- See page 185 for liquid density conversion factors.
- For TP tips use Quick TeeJet® cap and gasket 25608-1-NYR.



FERTILIZER NOZZLES

TIP PART NO.	CAPACITY ONE NOZZLE IN l/min	APPLICATION RATE FOR 75 cm SPRAY NOZZLE SPACING										
		4 km/h	6 km/h	8 km/h	10 km/h	15 km/h	18 km/h	20 km/h	25 km/h	30 km/h	35 km/h	
TP0001-SS	1.0	0.23	46.0	30.7	23.0	18.4	12.3	10.2	9.2	7.4	6.1	5.3
	1.5	0.28	56.0	37.3	28.0	22.4	14.9	12.4	11.2	9.0	7.5	6.4
	2.0	0.32	64.0	42.7	32.0	25.6	17.1	14.2	12.8	10.2	8.5	7.3
	2.5	0.36	72.0	48.0	36.0	28.8	19.2	16.0	14.4	11.5	9.6	8.2
TP00015-SS	1.0	0.34	68.0	45.3	34.0	27.2	18.1	15.1	13.6	10.9	9.1	7.8
	1.5	0.42	84.0	56.0	42.0	33.6	22.4	18.7	16.8	13.4	11.2	9.6
	2.0	0.48	96.0	64.0	48.0	38.4	25.6	21.3	19.2	15.4	12.8	11.0
	2.5	0.54	108	72.0	54.0	43.2	28.8	24.0	21.6	17.3	14.4	12.3
H1/4U-SS0002 TP0002-SS	1.0	0.46	92.0	61.3	46.0	36.8	24.5	20.4	18.4	14.7	12.3	10.5
	1.5	0.56	112	74.7	56.0	44.8	29.9	24.9	22.4	17.9	14.9	12.8
	2.0	0.65	130	86.7	65.0	52.0	34.7	28.9	26.0	20.8	17.3	14.9
	2.5	0.72	144	96.0	72.0	57.6	38.4	32.0	28.8	23.0	19.2	16.5
H1/4U-SS0003 TP0003-SS	1.0	0.68	136	90.7	68.0	54.4	36.3	30.2	27.2	21.8	18.1	15.5
	1.5	0.83	166	111	83.0	66.4	44.3	36.9	33.2	26.6	22.1	19.0
	2.0	0.96	192	128	96.0	76.8	51.2	42.7	38.4	30.7	25.6	21.9
	2.5	1.08	216	144	108	86.4	57.6	48.0	43.2	34.6	28.8	24.7
H1/4U-SS0004 TP0004-SS	1.0	0.91	182	121	91.0	72.8	48.5	40.4	36.4	29.1	24.3	20.8
	1.5	1.12	224	149	112	89.6	59.7	49.8	44.8	35.8	29.9	25.6
	2.0	1.29	258	172	129	103	68.8	57.3	51.6	41.3	34.4	29.5
	2.5	1.44	288	192	144	115	76.8	64.0	57.6	46.1	38.4	32.9
H1/4U-SS0006 TP0006-SS	1.0	1.37	274	183	137	110	73.1	60.9	54.8	43.8	36.5	31.3
	1.5	1.67	334	223	167	134	89.1	74.2	66.8	53.4	44.5	38.2
	2.0	1.93	386	257	193	154	103	85.8	77.2	61.8	51.5	44.1
	2.5	2.16	432	288	216	173	115	96.0	86.4	69.1	57.6	49.4
H1/4U-SS0008 TP0008-SS	1.0	1.82	364	243	182	146	97.1	80.9	72.8	58.2	48.5	41.6
	1.5	2.23	446	297	223	178	119	99.1	89.2	71.4	59.5	51.0
	2.0	2.58	516	344	258	206	138	115	103	82.6	68.8	59.0
	2.5	2.88	576	384	288	230	154	128	115	92.2	76.8	65.8
H1/4U-SS0010 TP0010-SS	1.0	2.28	456	304	228	182	122	101	91.2	73.0	60.8	52.1
	1.5	2.79	558	372	279	223	149	124	112	89.3	74.4	63.8
	2.0	3.22	644	429	322	258	172	143	129	103	85.9	73.6
	2.5	3.60	720	480	360	288	192	160	144	115	96.0	82.3
H1/4U-SS0015 TP0015-SS	1.0	3.42	684	456	342	274	182	152	137	109	91.2	78.2
	1.5	4.18	836	557	418	334	223	186	167	134	111	95.5
	2.0	4.83	966	644	483	386	258	215	193	155	129	110
	2.5	5.40	1080	720	540	432	288	240	216	173	144	123
H1/4U-SS0020 TP0020-SS	1.0	4.56	912	608	456	365	243	203	182	146	122	104
	1.5	5.58	1116	744	558	446	298	248	223	179	149	128
	2.0	6.45	1290	860	645	516	344	287	258	206	172	147
	2.5	7.21	1442	961	721	577	385	320	288	231	192	165
H1/4U-SS0030 TP0030-SS	1.0	6.84	1366	911	683	546	364	304	273	219	182	156
	1.5	8.37	1674	1116	837	670	446	372	335	268	223	191
	2.0	9.66	1932	1288	966	773	515	430	386	309	258	221
	2.5	10.8	2160	1440	1080	864	576	480	432	346	288	247
H1/4U-SS0040 TP0040-SS	1.0	9.11	1822	1215	911	729	486	405	364	292	243	208
	1.5	11.2	2240	1493	1120	896	597	496	448	358	299	256
	2.0	12.9	2580	1720	1290	1032	688	573	516	413	344	295
	2.5	14.4	2880	1920	1440	1152	768	640	576	461	384	329
H1/4U-SS0050	1.0	11.4	2280	1520	1140	912	608	507	456	365	304	261
	1.5	13.9	2780	1853	1390	1112	741	620	556	445	371	318
	2.0	16.1	3220	2147	1610	1288	859	716	644	515	429	368
	2.5	18.0	3600	2400	1800	1440	960	801	720	576	480	411
H1/4U-SS0060	1.0	13.7	2740	1827	1370	1096	731	608	548	438	365	313
	1.5	16.7	3340	2227	1670	1336	891	744	668	534	445	382
	2.0	19.3	3860	2573	1930	1544	1029	860	772	618	515	441
	2.5	21.6	4320	2880	2160	1728	1152	961	864	691	576	494

**Note:** Always double check your application rates. Tabulations are based on spraying water at 21°C. See technical information (pages 179–202) for useful formulas and other technical information.

## Typical Applications



**FERTILIZER DIRECTED**  
**EXCELLENT**



**DRIFT CONTROL**  
**EXCELLENT**

## SPRAY PATTERN

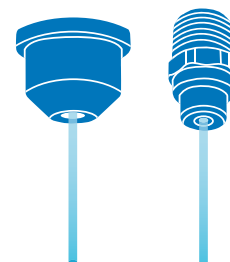

## MATERIALS AVAILABLE

**SS** STAINLESS STEEL

## HOW TO ORDER

Stainless Steel  
**H 1 / 4 U - S S 0 0 1 0**

Tip Type      Material Code      Capacity Size

# TeeJet® TANK RINSING



## 55270

- Rotating head driven by the flow of the rinsing liquid through multiple round spray orifices.
- Solid stream sprays are precisely positioned to provide effective internal wetting and cleaning of tank surface.
- Removable retainer and rotating body allows for disassembly and cleaning.
- Provides 360° coverage of inside surface of tank for tank diameters up to 3.0 m.
- Self-lubricating and self-flushing design.

- Materials: Body: black POM (acetal); Fasteners: stainless steel.
- Recommended operating pressure 0.7–3.5 bar.
- Mounting connection: ½" or ¾" NPT or BSPT (F).

### Typical Application

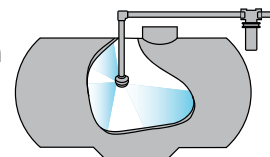

NOZZLE NUMBER	CAPACITY (l/min)					TYPE OF COVERAGE	SPRAY ANGLE
	0.7 bar	1.5 bar	2 bar	3 bar	3.5 bar		
55270-1/2-11-POM	22.3	30.8	35.3	43.5	47.3		360°
B55270-1/2-11-POM							
55270-3/4-18-POM	34.0	50.0	58.0	71.0	77.0		
B55270-3/4-18-POM							



## D41892

- The rotary tank rinsing nozzle is used for rinsing the insides of chemical containers and spray tanks up to 2.0 m in diameter.
- Available with ½" NPT or BSPT (F) connections.

- Significant lower rotating speed at approximately 15% of typical speed, results in faster and more thorough cleaning of tank surface.
- Self-cleaning sliding bearing.
- Body and inserts are made of POM (Acetal).
- Nozzle fits in 37 mm opening.
- Recommended operating pressure 2–4 bar with a maximum pressure 8 bar.

NOZZLE NUMBER	CAPACITY (l/min)				
	1.5 bar	2 bar	3 bar	4 bar	5 bar
D41892-(B)1/2-POM-6	15.9	18.3	22.5	26.0	29.0

# TeeJet® CONTAINER RINSING



## 23240

- The 23240 container rinsing nozzle is used to rinse residue from containers before disposal.
- Can be used for containers with 26 mm diameter openings or larger.

- Three flat spray orifices provide self-rotational forces needed to create spherical coverage.
- Available in ½" NPT or BSPT (F) connections.

### Typical Application

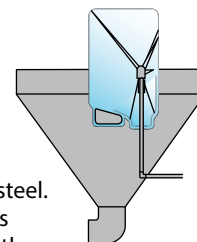

- Made of 316 stainless steel. HSS bearings and races have been replaced with 316SS bearings and races. Also includes an internal sleeve made of Nylon.

NOZZLE NUMBER	INLET PIPE CONNECTION	CAPACITY (l/min)				
		1.5 bar	2 bar	2.5 bar	3 bar	4 bar
(B)23240-3-316SS-5.7-316SS	½" (F)	13.9	16.1	18.0	19.7	23.0
(B)23240-3-316SS-7-316SS		19.5	23.0	25.0	28.0	32.0



## VSM

- Used for inside rinsing of chemical containers.
- Fourty orifices combine to produce a 240° spray angle.

- All Nylon construction.
- Available with ½" or ¾" NPT or BSPT (F) connection.
- Recommended operating pressure 2–4 bar.

NOZZLE NUMBER	INLET PIPE CONNECTION	ORIFICE DIAMETER	CAPACITY (l/min)						SPRAY ANGLE
			0.5 bar	1 bar	2 bar	3 bar	5 bar	10 bar	
(B) VSM-*-28	½" (F)	0.80 mm	8.8	12.5	17.7	21.7	28.0	39.5	240°
(B) VSM-*-44		1.00 mm	13.9	19.7	27.9	34.1	44.0	62.3	
(B) VSM-*-90	½" or ¾" (F)	1.50 mm	28.5	40.3	56.9	69.7	90.0	127	
(B) VSM-*-140		1.95 mm	44.3	62.6	88.5	108	140	198	
(B) VSM-*-190		2.30 mm	60.1	85.0	120	147	190	269	

### HOW TO ORDER

( B ) V S M - 3 / 4 - 1 4 0  
 |        |        |        |  
 BSPT    Nozzle Type    Size        Capacity

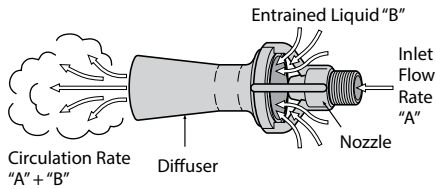

## 46550, Y33180 & Y9270

- Allows small pumps to circulate large volumes of liquid.
- Manufactured of glass-filled polypropylene for excellent corrosion and chemical resistance.
- Large flow opening minimizes plugging.
- Available in ¼", ⅜", ¾" or 1½" (M) pipe thread inlet connection.

APPROXIMATE FLOW RATE PERFORMANCE	MODEL NUMBER	INLET LIQUID PRESSURE						
		0.7 bar	1 bar	1.5 bar	2 bar	2.5 bar	3 bar	3.5 bar
Inlet Flow Rate "A" (l/min)	46550-1/4-PP	13.4	16.0	19.5	23	25	28	30
	Y33180-PP	34	41	50	58	65	71	77
	Y9270-PP	51	62	75	87	97	107	115
Entrained Liquid "B" (l/min)	46550-1-1/2-PP	125	151	184	215	243	259	288
	46550-1/4-PP	50	59	72	84	93	102	110
	Y33180-PP	138	164	201	232	259	284	307
Circulation Rate "A+B" (l/min)	Y9270-PP	206	246	301	348	389	426	460
	46550-1-1/2-PP	502	604	736	860	972	1036	1152
	46550-1/4-PP	63	75	92	107	118	130	140
Circulation Rate "A+B" (l/min)	Y33180-PP	172	205	251	290	324	355	384
	Y9270-PP	257	308	376	435	486	533	575
	46550-1-1/2-PP	627	755	920	1075	1215	1295	1440

### HOW TO ORDER

Y 3 3 1 8 0 - P P

MODEL NUMBER	PIPE THREAD INLET CONNECTION	ORIFICE DIAMETER (mm)	LENGTH (mm)	DIAMETER (mm)
46550-1/4-PP	¼" (M)	4.8	76	32
Y33180-PP	⅜" (M)	7.9	103	52
Y9270-PP	¾" (M)	9.5	162	74
46550-1-1/2-PP	1½" (M)	14.3	254	114

# TeeJet® JET AGITATORS

Installed at bottom of spray tank on end of agitator return line. Continuous solid stream jet flow creates turbulence and keeps wettable powders in suspension.



## 6290-SC

Made in choice of brass, aluminum and all stainless steel. ¼" NPT (F) inlet connection. Fits through 51 mm hole. Weight 0.17 kg. Siphon caps increase liquid flow by Venturi action to increase mixing potential.

### HOW TO ORDER

Brass

6 2 9 0 S C - 1

Aluminum

6 2 9 0 S C - 1 - A L

Stainless Steel

6 2 9 0 S C - 1 - S S

JET AGITATOR NUMBER	ORIFICE CAP NUMBER	ORIFICE CAP INLET DIA. (cm)	CAPACITY (l/min) THRU AGITATOR LINE AT VARIOUS PRESSURES						FOR MAX. TANK SIZE IN LITERS OF:
			1 bar	1.5 bar	2 bar	2.5 bar	3 bar	3.5 bar	
6290SC-1	11118-1	1.39	3.5	4.5	5	5.5	6	6.5	200
6290SC-2	11118-2	2.18	8.5	10.5	12	13.5	15	16	400
6290SC-3	11118-3	2.43	11	13.5	15.5	17.5	19	20	500
6290SC-5	11118-5	3.65	20	25	28	32	35	38	900
6290SC-8	11118-8	3.96	23	28	33	37	40	43	1100
6290SC-10	11118-10	4.49	26	32	37	41	45	48	1300

**Note:** Maximum tank sizes shown in table are approximate and are based on 3 bar operation with pesticides, not fertilizers.

## MATRIX® 430 GUIDANCE (BROAD ACREAGE)

The compact Matrix 430 is an easy-to-use, low-cost, graphical guidance system ideal for first-time users. The full-color, touchscreen display allows the operator to efficiently navigate fields with minimal skips and overlaps in coverage.

- Versatile GNSS guidance in a compact, portable package.
- Full time, on screen numeric display of cross-track error with user selectable display of two additional parameters including: worked area, worked time, and ground speed.
- High-quality, internal GPS/GLONASS engine with ClearPath technology that enhances GNSS performance.
- Guidance modes include: Straight AB, Curved AB, Circle Pivot, and Last Pass.
- Applied alert provides operator with audible alarm when entering previous applied areas.
- Simple reporting function provides coverage reports in .KML or .PDF.



PART NUMBER	DESCRIPTION
GD430-GLO-P-B	Kit, Matrix 430, GLONASS, Patch Antenna, Battery Leads
GD430-GLO-P-L	Kit, Matrix 430, GLONASS, Patch Antenna, US Lighter Connector
GD430-GLO-R30-B	Kit, Matrix 430, GLONASS, RXA-30 Antenna, Battery Leads
GD430-GLO-R30-L	Kit, Matrix 430, GLONASS, RXA-30 Antenna, US Lighter Connector

## MATRIX 430VF GUIDANCE (VINEYARDS/ORCHARDS)

Matrix 430VF is an easy-to-use, reliable, and cost-effective GNSS guidance system specifically designed to simplify operations in vineyards and orchards. It offers the functionality and reporting features of the original Matrix 430, but with mapping and guidance features specific to these specialized applications.

- Applied rows are colored to show where applications have occurred, and where skips or double applications have occurred.
- Alerts operator when entering an applied row or area.
- Storage for up to five jobs make record keeping easy.
- Five different machine profiles allow easy switching between machines or machine setups.
- Excellent display visibility in bright light or at night.
- Easy to understand and easy to use.



PART NUMBER	DESCRIPTION
GD430VF-GLO-P-B	Kit, Matrix 430VF, GLONASS, Patch Antenna, Battery Leads
GD430VF-GLO-P-L	Kit, Matrix 430VF, GLONASS, Patch Antenna, US Lighter Connector
GD430VF-GLO-R30-B	Kit, Matrix 430VF, GLONASS, RXA-30 Antenna, Battery Leads
GD430VF-GLO-R30-L	Kit, Matrix 430VF, GLONASS, RXA-30 Antenna, US Lighter Connector



# MATRIX 908

Matrix 908 is built for expandability, rugged performance, and easy operation in many agricultural and turf applications. As the latest in the Matrix family, the Matrix 908 offers a bright, clear display, intuitive menu structure and long-lasting construction. Choose a field navigation model for GNSS guidance and coverage mapping, including automatic boom section control. Or opt for an ISOBUS-ready model that performs guidance functions plus an ISOBUS UT for sprayer or spreader control. The high-performance, built-in GNSS receiver offers accuracy upgrade options with no change in hardware, making the Matrix 908 a great fit for a wide range of current or future applications.

- Integrated GNSS receiver offers upgradable accuracy with no changes in console or antenna hardware.
- Base version offers guidance, mapping, and automatic section control; an ISOBUS UT and task control available via convenient feature unlock.
- TwinView allows the operator to view guidance and UT screen side-by-side.
- The 203 mm high-resolution display can be viewed in bright daylight or set to night mode for low-light conditions.
- Rugged metal enclosure makes the Matrix 908 durable and long lasting.



MOBILE ELECTRONICS

### NAV WITH HARNESS KITS & INTERNAL RECEIVER

PART NUMBER	DESCRIPTION
90-1006-ENUS	Kit, M908 NAV-L1-GLO-ENUS
90-1007-ENUS	Kit, M908 NAV-L2+TSL-GLO-ENUS
90-1008-ENUS	Kit, M908 NAV-L2+TSC-GLO-ENUS

### ISO WITH HARNESS KITS & INTERNAL RECEIVER

PART NUMBER	DESCRIPTION
90-10011-ENUS	Kit, M908 ISO-L1-GLO-ENUS
90-10012-ENUS	Kit, M908 ISO-L2+TSL-GLO-ENUS
90-10013-ENUS	Kit, M908 ISO-L2+TSC-GLO-ENUS

### 90-10006-ENUS KITS PARTS DIAGRAM

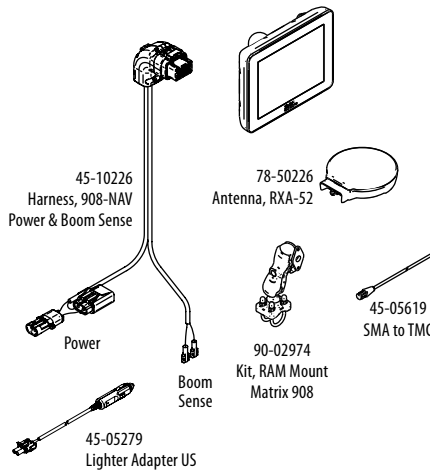

### 90-10011-XX KITS PARTS DIAGRAM

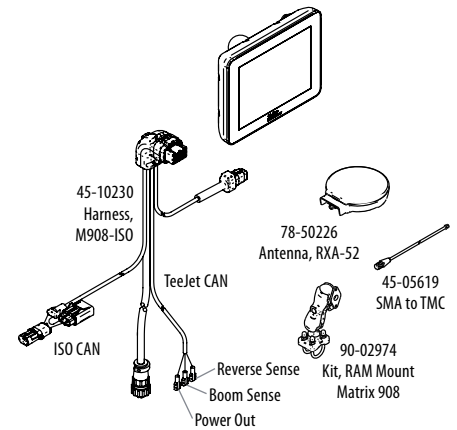

## M 9 0 8 N A V - L 1 - G L O - E N

MODEL	
908	203 mm Screen

CONFIGURATION	
NAV	Navigation
ISO	ISOBUS

GNSS FREQUENCY CONFIGURATION	
N	No Internal Receiver
L1	Single Frequency SBAS
L2+TSL	Dual Frequency with TERRASTAR-L
L2+TSC	Dual Frequency with TERRASTAR-C

GNSS CONSTELLATIONS	
N	No Internal Receiver
GLO	GLONASS

LANGUAGES	
EN	English Metric
EN US	English US Units
BG	Bulgarian
CZ	Czech
DA	Danish
DE	German
ES	Central & South America
ET	Estonian
FI	Finnish

## MATRIX 908 SYSTEM DIAGRAM

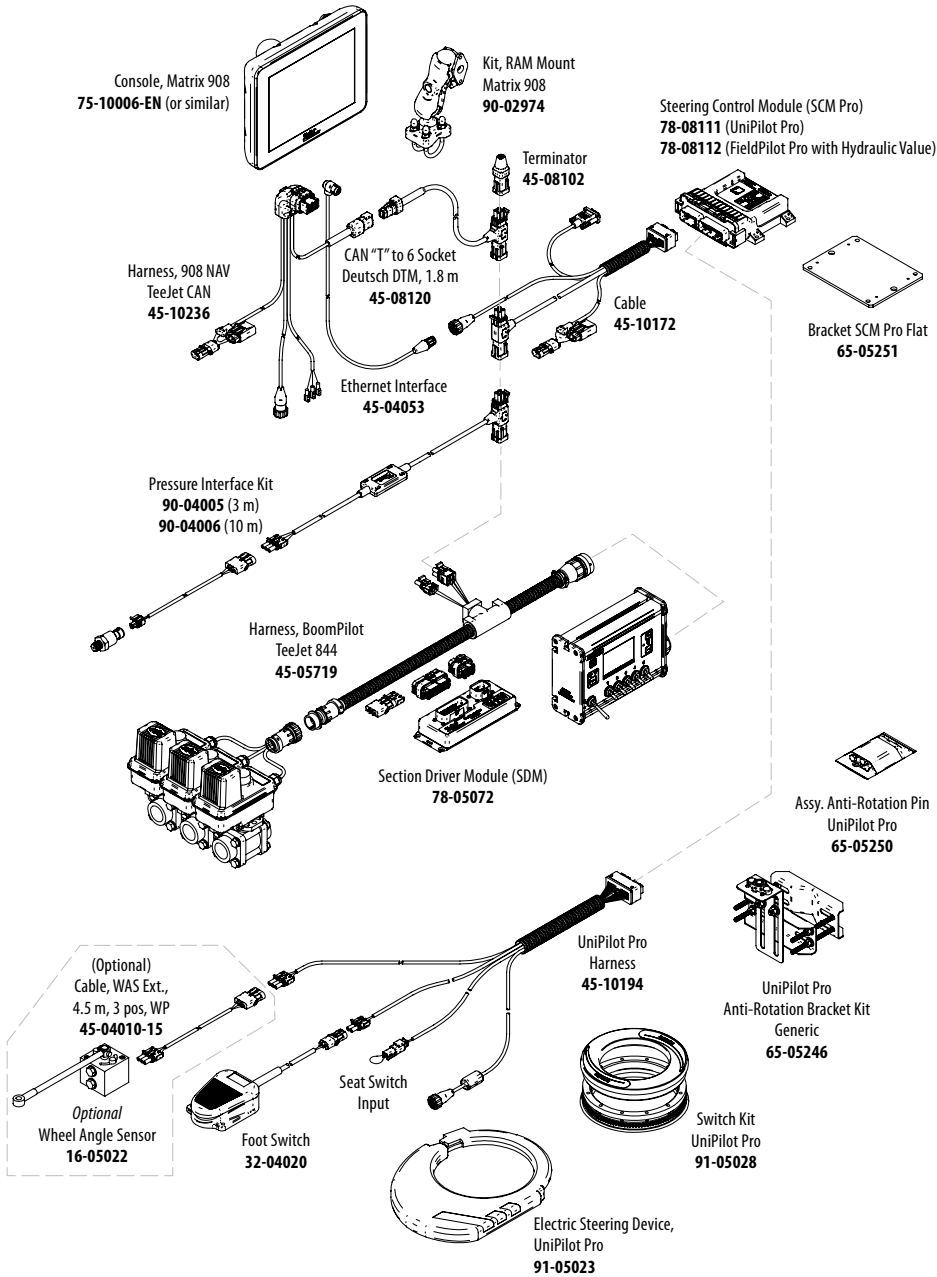

## ACCESSORIES



### UNIPILOT® PRO

- Automatic steering solution.
- Easy to install without removing steering wheel.
- Fast to transfer between different applications.
- Compatible with a broad range of machines.
- Upgradable feature for Matrix 908, 570GS, and 840GS consoles.



### BOOMPILOT® KITS

- Automatically control boom section valves according to GPS as applied mapping.
- Eliminate costly overlaps or skips that can occur from manual control.
- Compatible with sprayers and dry spreaders.
- Can control up to 15 sections.
- BoomPilot kits developed to interface with a wide variety of existing controllers.



744E-3



744A-3

## 744 MANUAL SPRAYER CONTROLS

The 744 family of sprayer controls offer simple manual control of electric boom section valves and an electric pressure regulating valve. These controls are available in a range of kits configured for connection to solenoid or ball valves. The 744 offers a backlit pressure gauge and LEDs to indicate section switch status. A convenient master switch allows all boom sections to be switched simultaneously.

- 744A kits offered with 3 section switches and a choice of 7 or 20 bar gauges.
- 744E kits offered with 7 bar gauge and choice of 3 or 5 section switches.
- Kits include convenient harnesses to make connections fast and easy. Optional extension cables allow custom fit to many machine types.

### 3 SECTION 744 (100 PSI) BALL VALVE KITS

PART NUMBER	DESCRIPTION
90-02439-MP	Kit, 744A, 3 Boom 7 bar, Metri-Pack Ball Valve Harness
90-02439-MD	Kit, 744A, 3 Boom 7 bar, MINI-DIN Ball Valve Harness
90-02439-UX	Kit, 744A, 3 Boom 7 bar, 4 POS WP Valve Harness
90-50254	Kit, 744A, 3 Boom 7 bar, with 430 DIN Harness

### 3 SECTION 744 (100 PSI) SOLENOID KITS

PART NUMBER	DESCRIPTION
90-50149	Kit, 744A, 3 Boom 7 bar, Solenoid Cables
90-50161	Kit, 744A, 3 Boom 7 bar, Solenoid Cables, with 244C 3/4 Reg Valve
90-50163	Kit, 744A, 3 Boom 7 bar, Solenoid Cables, with 244C 3/4 Reg Valve & 144A-3
90-50177	Kit, 744A, 3 Boom 7 bar, Solenoid Cables, with 244C 3/4 Reg Valve & 144P-3

## BALL VALVE SYSTEM DIAGRAM

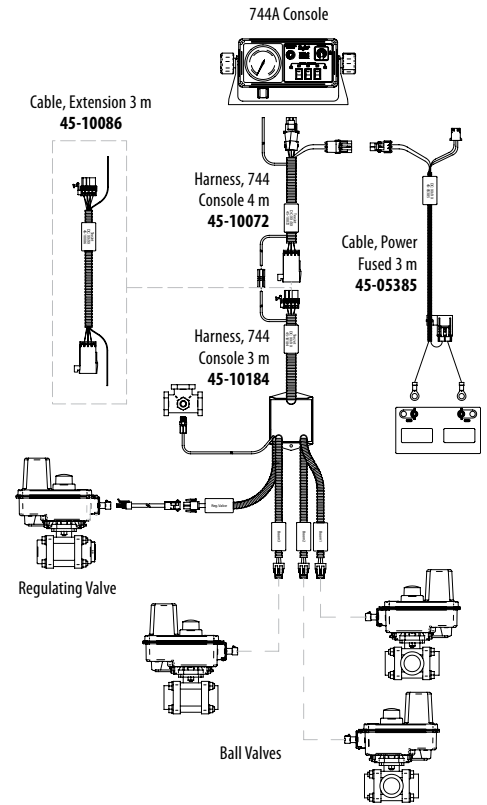

## SOLENOID VALVE SYSTEM DIAGRAM

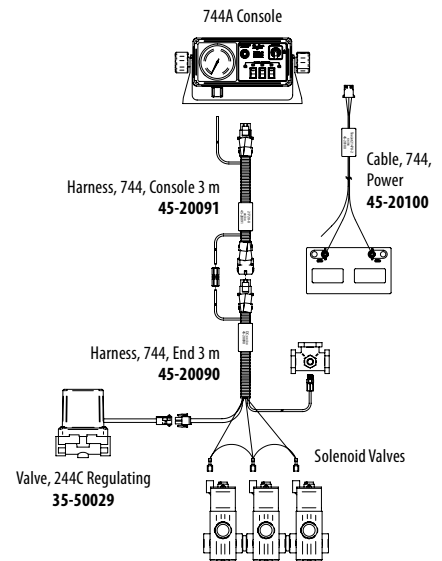

## RADION 8140 AUTOMATIC SPRAYER CONTROL

Radion is an advanced automatic spray controller that features a touch screen interface. The planning tool automatically shows the available speed range for the spray tip capacity that has been selected.

- 109 mm touch-screen display is packed with useful information and can be configured to match the user's preferences.
- Tank level monitoring and automatic tank filling features are included.
- Droplet size function shows the operator approximate droplet size based on the selected nozzle and application pressure.
- Compatible with 844, 854 and 845-style wiring harness
- Available in models to control 5, 7 or 9 boom sections
- Performs GPS-based automatic section control when connected to a Matrix 908 field computer (feature unlock required)



PART NUMBER	DESCRIPTION
90-50259	Kit, Radion 8140-5, RAM Mount, 4 m Power Cable, User Guide
90-50263	Kit, Radion 8140-7, RAM Mount, No Cables, User Guide
90-50265	Kit, Radion 8140-9, RAM Mount, No Cables, User Guide

## TEEJET 845 SPRAYER CONTROL

The TeeJet 845 was designed with simplicity in mind. The updated color display is easily visible in all light conditions and makes operation easier than ever. Key application data is always visible—including speed, application rate, volume sprayed, system pressure, and area covered. The 845 can be operated in flow or pressure-based regulation modes and offers 5 boom section control switches plus a master switch.

- Updated LCD display is backlit and easier to read than previous models.
- A single cable connection allows for easy installation and removal.
- Simple step-by-step programming is logical and easy to maneuver.
- Durable weather-resistant aluminum enclosure is durable and offers easy mounting options.
- Built-in planning tool makes spray tip selection easy.



PART NUMBER	DESCRIPTION
90-50268	Kit, 845, Mounting Bracket, 4 m Power Cable, User Guide
90-50143	Kit, 845, Mounting Bracket, No Cables, User Guide

### 845 SYSTEM DIAGRAM WITH BALL VALVE CABELING

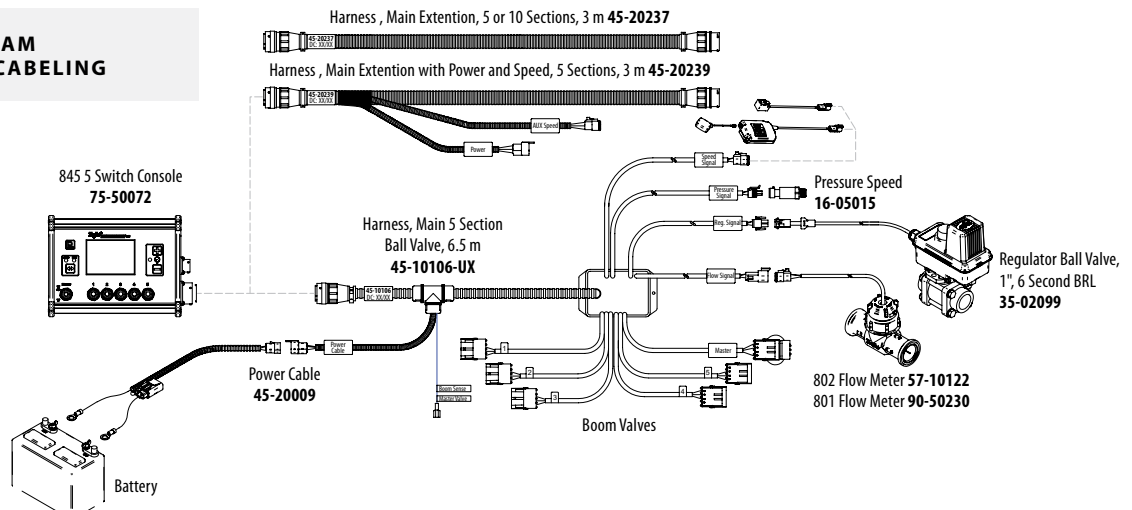



DynaJet is a nozzle control platform that extends the limits of your sprayer using PWM nozzle control. PWM stands for pulse width modulation, a technique of controlling nozzle flow rate by rapidly switching each nozzle on and off to control flow rate. Higher on time (or duty cycle) means greater flow, lower duty cycle means less flow. This control allows flow rate and pressure to be managed independently, which enables advanced application capabilities.

DynaJet alternates the on/off status of each nozzle to eliminate skips. DynaJet also performs turn compensation, applying greater rates on the outside of a turn than the inside.

- Extended speed or application rate working while maintaining pressure.
- Easily set the operating pressure from the cab, and DynaJet maintains application rate by changing nozzle duty cycle.
- 20 Hertz on/off frequency eliminates concerns about skips between spray pulses.
- Make a wide range of applications (rates, speeds and droplet sizes) with a single nozzle.
- DynaJet controls each nozzle individually, allowing swath control with high accuracy.
- Make your spray distribution uniform during turns with the Turn Compensation feature.
- On/Off control of up to 150 individual nozzles when connected to TeeJet IC45 rate control.
- Control of up to 30 sections with a third-party controller.
- Solenoid valves and cabling system tested and proven in the harshest environments, including application of liquid nitrogen fertilizer.



DynaJet ECU: DM-02

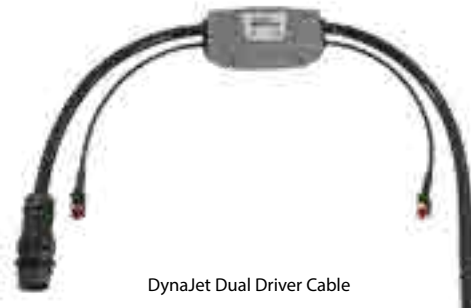

DynaJet Dual Driver Cable





## DYNAJET SYSTEM DIAGRAM

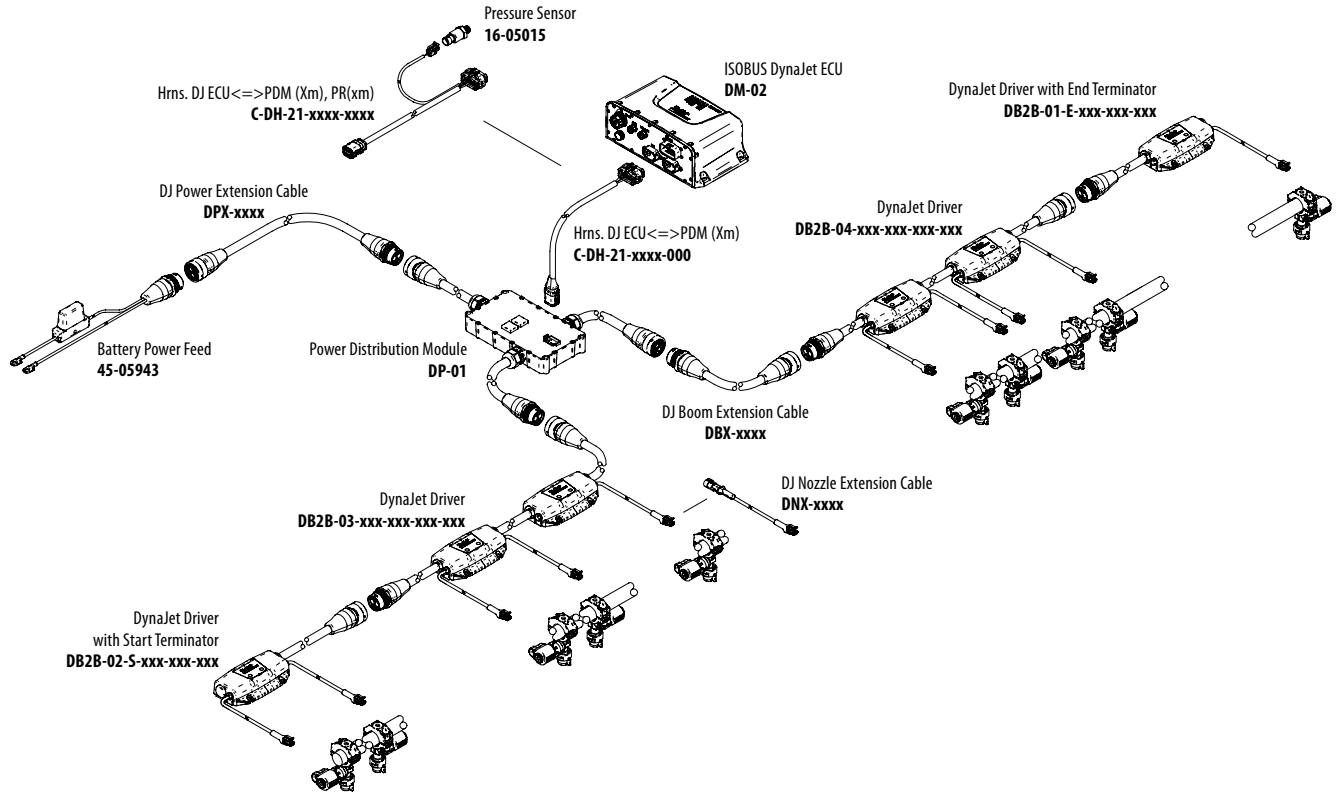

DynaJet is compatible with TeeJet solenoid valves. These nozzle valves are designed with PWM in mind. They balance power efficiency, flow capacity and durability. See page 134 for more details on TeeJet PWM nozzle solenoid valves.



115880 DynaJet Valve



116280 DynaJet High Flow Valve



Contact a sprayer manufacturer to discuss how to get DynaJet on your next sprayer.





IC45 integrates the latest in rate control features and functionality from TeeJet®. Fast and stable spray regulation is combined with modular expansion options to create a complete spray control platform.

- Updated user interface is attractive and easy to navigate.
- Modular design that allows convenient fitting on any type of sprayer.
- Section valves controlled by driver modules that control 12 valves per module. Multiple modules can be fitted, allowing control of high numbers of sections and/or other electrical functions.
- Additional modular features include tank filling with remote control station, drawbar or sprayer wheel steering for trailed sprayers, ISOBUS AUX control, with more functionality to come.
- Control for up to 30 boom section valves, or up to 150 individual nozzles when combined with DynaJet IC7140.
- Designed to operate with third party ISOBUS terminals.
- Engineered for reliability and long life.
- External status LEDs allow quick status confirmation.
- USB port for easy firmware updates.
- Multiple cable lengths to suit your needs.



IC45 ECU



IC45 Graphical Interface on Matrix 908 UT



ISOBUS Sprayer Cable



PLP 12 Output Driver

MOBILE ELECTRONICS



**DYNAJET & IC45 BRING ADVANCED FEATURES TO YOUR SPRAYER**

IC45 is the brand new ISOBUS Job computer. It integrates the best regulating performance and functionality from TeeJet.

DynaJet is a nozzle control platform that extends the limits of your sprayer by using PWM nozzle control.

When used together, DynaJet and IC45 become more than the sum of each component. By communicating with each other, the DynaJet and IC45 ECUs can offer advanced features, including:

- Extremely fast and stable regulating performance across a wide range of flow rates—even down to single nozzles.
- Complex manual bed application patterns with different rates by section.
- Map-driven applications that include different rates across the boom.
- Dynamic section widths depending on manual or automatic operating modes.
- Compatibility with advanced spot spraying systems.
- Easy to use on-screen virtual switch box.



DynaJet ECU



IC45 Sprayer Control

- ✓ **MORE PERFORMANCE**
- ✓ **MORE FEATURES**
- ✓ **MORE SAVINGS**



Variable Rate Application By Sections



Bed & Row Support



Spot Spraying Compatible

MOBILE ELECTRONICS



**ISOBUS SPREADER JOB COMPUTER IC38**

IC38 integrates the latest in spreader rate control features and functionality from TeeJet. A foundation of fast and stable spreader regulation is combined with other functions to create a complete spreader control platform.

- Available for Belt spreaders and drop spreaders.
- Control of up to 3 different products.
- Variable rate compatible via ISOBUS.
- Spinner speed control.
- Belt(s) speed control.
- Section control of up to 12 sections.
- Static and dynamic weighing interface.
- Designed to operate with third-party ISOBUS terminals.
- Junction-box style wiring system makes installation simple.



IC38 ECU



IC38 Graphical Interface on Matrix 908 UT



## PRESSURE SENSOR

- Available in two pressure ranges for maximum accuracy in your application.
- Reverse polarity protected.
- Weather-resistant connector.
- 10 and 25 bar.
- ¼" NPT connections.
- Sensors can withstand 2x rated pressure without damage.



Pressure Sensor

## 800 SERIES FLOW METER

- Turbine style design for optimal accuracy.
- Durable ruby-bearings for long wear life.
- Easily removed "quick check" turbine design for quick cleanup and service.
- Operating voltage of +4.5–16 VDC with LED status light.
- Wetted parts are glass-filled polypropylene, stainless steel and Viton.
- Wide range of plumbing fittings available with DirectoValve flange fittings.
- Wide range of cable connectors for compatibility to many brands of rate controllers.



801 & 802 Flow Meters

PART NUMBER	DESCRIPTION	FLOW CAPACITY*
801A	801A Flow Meter, 4 Bolt Flange, 20 bar	7.5–170 l/min
801	801 Flow Meter, 50 Series Flange, 20 bar	7.5–170 l/min
802	802 Flow Meter, 75 Series Flange, 20 bar	11–492 l/min

\*1 bar pressure drop at max rated flow.

## D SERIES FLOW METER

- Simple paddle wheel design for minimal flow restriction.
- Nylon construction for chemical resistance and durability.
- Sensor assembly easily removed for service.
- Pin clip-on hose barbs for easy removal from plumbing systems.
- 16 bar pressure rating.
- Wide range of cable connectors for compatibility to many brands of rate controllers.



16D Flow Meter

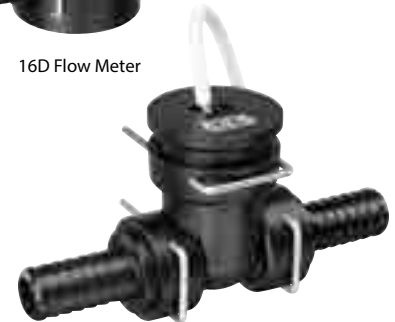

20D Flow Meter

PART NUMBER	DESCRIPTION	FLOW CAPACITY*
10D Series	10 mm Flow Meter	3.8–55.0 l/min
16D Series	16 mm Flow Meter	7.0–64.0 l/min
20D Series	20 mm Flow Meter	15.0–145.0 l/min
26D Series	26 mm Flow Meter	20.0–400.0 l/min

\*1 bar pressure drop at max rated flow. Please see Technical Document 98-01111 for detailed ordering information.

## GPS SPEED SENSOR

The GPS Speed Sensor uses a GPS receiver to measure true ground speed, then delivers a frequency signal compatible with the radar speed signal input of on most controllers and monitors.

- Eliminates problems frequently found with radar speed sensors on wet surfaces, with moving crops, or vehicle vibration.
- Convenient enclosure mounts inside cab, only small patch antenna is mounted outside.
- Status LEDs show power, GPS lock, and speed output conditions.
- Wide range of adapter cables available making it compatible with all popular application rate control systems.
- Speed range 0.8–129 km/h.



GPS Speed Sensor



### COLOR CODE

1	2	3	4	5	6	7	8	9	10	11	12	13
Black	White	Red	Blue	Green	Yellow	Brown	Orange	Gray	Violet <sup>3</sup>	Lt. Blue <sup>4</sup>	Raspberry Red <sup>5</sup>	Lt. Green <sup>5</sup>

### ORDERING INFORMATION

QUICK TEEJET® CAPS	PART NUMBER		FOR USE WITH FLAT SPRAY TIPS 20 BAR MAXIMUM PRESSURE
	QUICK TEEJET CAP ONLY	QUICK TEEJET CAP & SEAT GASKET SET	
	CP114440A-*.CE	114441A-*.CELR	<b>TeeJet® Flat Spray Tips (Smaller Capacities)</b> TP Standard -0067 to -08 XR TeeJet® -01 to -08 Turbo TwinJet® (TTJ60) AIXR TeeJet® -015 to -06
		114441A-*.CELVI	
	CP25611-9-PP <sup>1</sup>	25612-9-PP <sup>1</sup>	DG TeeJet® Turbo TeeJet® (TT) -01 to -08 OC TeeJet® & TQ150 AccuPulse® TwinJet® (APTJ)
	CP25609-*.NY	25610-*.NYR	<b>TeeJet Flat Spray Tips (Larger Capacities)</b> TP Standard -10 to -20 XR TeeJet® -10 to -15
	CP114442A-*.CE	114443A-*.CELR	TJ60 TwinJet® AI TeeJet® & AIUB TeeJet® AI Turbo TwinJet® (AITTJ60) -02 to -06 Turbo TeeJet® Induction (TTI) -01 to -06 DG TwinJet® SJ3 StreamJet AIXR TeeJet® -08 to -10 TP Standard 30 to 70
		114443A-*.CELVI	
	CP115834A-*.CE	115835A-*.CELR	Turbo TeeJet® Induction (TTI) -01 to -06
		115835A-*.CELVI	
	CP114501A-*.CE <sup>6</sup>	114502A-*.CELR <sup>6</sup>	AI Turbo TwinJet® (AITTJ60) -08 to -15 Turbo TeeJet® Induction (TTI) -08 to -10 Turbo TeeJet® (TT) -10 to -12
		114502A-*.CELVI <sup>6</sup>	
	CP98578-1-NY <sup>2</sup>	98579-1-NYR <sup>2</sup>	AI3070
	CP25595-*.NY	25596-*.NYR	<b>TeeJet Flat Spray Tips (Smaller Capacities)</b> Tips can be positioned in choice of two spray plane directions—parallel or perpendicular to wings of Quick TeeJet cap.
	CP25599-*.NY	25600-*.NYR	Turbo FloodJet® TK-VP FloodJet® TK-VS FloodJet® Locating Nib
	CP114444A-*.CE	114445A-*.CELR	TK FloodJet® TX/TXA ConeJet® AITXA ConeJet 4916 Flow Regulator Disc Core
		114445A-*.CELVI	
	CP25607-9-PP <sup>1</sup>	25608-9-PP <sup>1</sup>	FL FullJet® TG Full Cone Hose Shank XE TeeJet
	CP25607-*.NY	—	Disc Seal Core CP18999-EPR Disc-Core (Insert Core into Seal)

\*Specify color code (see chart above).

<sup>1</sup> These caps only available in gray and rated to 10 bar.

<sup>2</sup> These caps only available in black.

<sup>3</sup> Color available in CP114440A, CP114442A and CP114444A caps.

<sup>4</sup> Color available in CP114440A, CP114442A and CP114501A caps.

<sup>5</sup> Color available in CP114501A and CP114440A caps.

<sup>6</sup> This cap offered in Black, White, Light Green, Light Blue and Raspberry Red only.



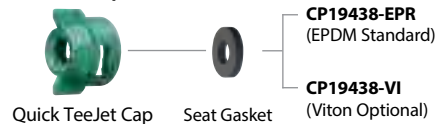







#### Quick TeeJet Cap & Seat Gasket Set

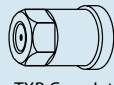

## COLOR CODE













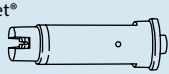

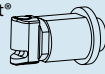

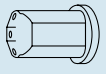
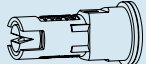





1	2	3	4	5	6	7	8	9	10	11	12	13
Black	White	Red	Blue	Green	Yellow	Brown	Orange	Gray	Violet <sup>3</sup>	Lt. Blue <sup>4</sup>	Raspberry Red <sup>5</sup>	Lt. Green <sup>5</sup>

## ORDERING INFORMATION

QUICK TEEJET CAPS	PART NUMBER		FOR USE WITH FLAT SPRAY TIPS 20 BAR MAXIMUM PRESSURE
	QUICK TEEJET CAP ONLY	QUICK TEEJET CAP & SEAT GASKET SET	
	CP26277-1-NY <sup>2</sup>	26278-1-NYR <sup>2</sup>	Ceramic Disc-Core     D-Disc Core TXB ConeJet AITXB ConeJet
	CP114395-1-NYB <sup>2</sup>	114396-1-NYR <sup>2</sup>	 114396-1-NYR includes gasket and O-Ring (CP7717-M10.5x1.5-VI). TXR ConeJet
	—	QJ4676-45-1/4-NYR <sup>2</sup>	45° Quick TeeJet cap with 1/4" NPT female threaded outlet.
	—	QJ4676-90-1/4-NYR <sup>2</sup>	90° Quick TeeJet cap with 1/4" NPT female threaded outlet.
	—	QJ4676-1/8-NYR <sup>2</sup>	Permits use of standard 1/8" and 1/4" nozzles. Can be used for mounting pressure gauge at the nozzle. (B) = BSPT
	—	QJ(B)4676-1/4-NYR <sup>2</sup>	
	—	114447A-1-CELR <sup>2</sup>	Provides shutoff at nozzle for quick spacing change or change in spray swath.
	—	114447A-1-CELVI <sup>2</sup>	

<sup>2</sup> These caps only available in black.

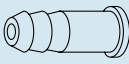
## CAPS FOR HARDI® NOZZLE BODIES

QUICK TEEJET CAPS	PART NUMBER		FOR USE WITH FLAT SPRAY TIPS 10 BAR MAXIMUM PRESSURE
	QUICK TEEJET CAP ONLY	QUICK TEEJET CAP & SEAT GASKET SET	
	CP21399- <sup>*</sup> -CE	21398H- <sup>*</sup> -CELR	 TJ60 TwinJet <sup>*</sup>  AI TeeJet <sup>*</sup> & AIUB TeeJet <sup>*</sup>  AI Turbo TwinJet <sup>*</sup> -02 to -06  Turbo TeeJet <sup>*</sup> Induction (TTI) -01 to -06  DG TwinJet <sup>*</sup>  S3J StreamJet  AIXR TeeJet <sup>*</sup> -08 to -10
	CP23307- <sup>*</sup> -CE	23306H- <sup>*</sup> -CELR	 TP Standard -0067 to -08  XR TeeJet -01 to -08  AIXR TeeJet <sup>*</sup> -015 to -06  DG TeeJet <sup>*</sup>  Turbo TeeJet <sup>*</sup> -01 to -08  OC TeeJet <sup>*</sup> -01 to -08  AccuPulse <sup>*</sup> TwinJet <sup>*</sup> -015 to -08
	CP58350- <sup>*</sup> -CE	58348H- <sup>*</sup> -CELR	 TK FloodJet <sup>*</sup>  FL FullJet <sup>*</sup>  TX ConeJet  TG Full Cone  Hose Shank  AITXA ConeJet

**Note:** When using TeeJet tip strainer, use CP26227 gasket in place of CP23308 gasket. See page 137 for 55240 Hardi to TeeJet adapter.

<sup>\*</sup>Specify color code (see chart above).



The QJS nozzle body utilizes a modular design that allows for highly customized solutions to best fit your sprayer and spraying application needs. Choose the boom size, inlet position, outlet arrangement and tip shutoff mechanism that works best.

- Multiple outlet, stackable nozzle body is ideal for mounted, trailed and self-propelled sprayers.
- Wet boom configuration offered with choice of bottom or side inlet in six different boom diameters ( $\frac{1}{2}$ ",  $\frac{3}{4}$ ", 1", 20 mm, 25 mm, and 28 mm); dry boom version also available in three sizes ( $\frac{1}{2}$ ",  $\frac{3}{4}$ ", 1").
- Can be equipped with any combination of TeeJet ChemSaver® tip shutoffs including pneumatic, electric, manual or spring-loaded check valve.
- Choose from one to four outlets in a variety of configurations.
- Wetted parts are nylon and FKM.
- Maximum operating pressure of up to 20 bar depending on the ChemSaver used.
- Flow rating of up to 10.4 l/min at 0.34 bar pressure drop and 15.1 l/min at 0.7 bar pressure drop depending on ChemSaver used.
- See pages 134–135 for additional info on ChemSaver shutoffs.



QJS-S2-EM  
(tips and caps sold separately)



QJS-B3-MAA



QJS-S2-EM



The QJS-D turret series nozzle body utilizes a modular design that allows for highly customized solutions to best fit your sprayer and spraying application needs. Choose the boom size, inlet position, outlet arrangement and tip shutoff mechanism that works best.

- Multiple outlet, stackable nozzle body, with turret, is ideal for mounted, trailed and self-propelled sprayers.
- Wet boom configuration offered with choice of bottom or side inlet in six different boom diameters (½", ¾", 1", 20 mm, 25 mm, and 28 mm).
- Can be equipped with any combination of TeeJet ChemSaver® tip shutoffs including pneumatic, electric, manual or spring-loaded check valve.
- Choose from a variety of configurations.
- Wetted parts are nylon and FKM.
- Maximum operating pressure of up to 20 bar depending on the ChemSaver used.
- Flow rating of up to 10.4 l/min at 0.34 bar pressure drop and 15.1 l/min at 0.7 bar pressure drop depending on ChemSaver used.
- See pages 134–135 for additional info on ChemSaver shutoffs.



QJS-D-1-EM-5-P



QJS-D-1-CM-3-P

### SAMPLE VALVE PART NUMBER

Q J S - D - 2 0 M M - \_ - C M - 3 \_ \_ - P \_ \_

SPLIT EYELET STYLE	
D	Standard
I	High Strength Inlet

CLAMP SIZES	
20 MM	20 mm Tubing
25 MM	25 mm Tubing
28 MM	28 mm Tubing
1/2	½" Pipe
3/4	¾" Pipe
1	1" Pipe

FLOW METER	
A	Side A
B	Side B
C	Both
BLANK	None

TOP & BOTTOM SHUTOFF TYPE	
C	Standard ChemSaver
M	Manual ChemSaver
E	12V e-ChemSaver
V	24V e-ChemSaver
A	Air ChemSaver
X	No ChemSaver

**Note:** Top shutoff controls side A and B; bottom shutoff controls bottom outlet.

**Note:** Assemblies are oriented with the split eyelet pointing forward. Side A is nearest the upper clamp, hinge pin; side B is opposite that. Position 1\* represents the outlet nearest the boom (when stacking perpendicular to the boom) or the far left (stacking parallel to the boom).

TURRET/SHUTOFF TYPE	
3	3 Outlet Turret Body
5	5 Outlet Turret Body
C	Body with 1 bar Check Valve
M	Body with Manual ChemSaver®
E	Body with 12V e-ChemSaver®
V	Body with 24V e-ChemSaver®
A	Body with Air ChemSaver®
X	Body without ChemSaver®
P	End Cap
BLANK	None

**Note:** Position 1 represents outlet nearest boom or far left. Code 3, 5 or P can only be selected at position 1. If Code 3, 5 or P is selected, Position 2 and 3 must be blank.

**Note:** See Data Sheet DS58585-1 or Parts List PLQJS-D for more information.

# Quick TeeJet® QJS-Y SERIES STACKABLE NOZZLE BODIES

The QJS-Y split outlet nozzle body utilizes a modular design that allows for highly customized solutions to best fit your sprayer and spraying application needs. Choose the boom size, inlet position, outlet arrangement and tip shutoff mechanism that works best.

- Two outlet, modular nozzle body, with unique Y configuration is ideal for sprayers equipped with PWM spray tip control systems.
- Wet boom configuration offered with choice of bottom or side inlet in six different boom diameters (1/2", 3/4", 1", 20 mm, 25 mm, and 28 mm).
- Can be equipped with any combination of TeeJet ChemSaver® tip shutoffs including pneumatic, electric, manual or spring-loaded check valve.
- Features two outlets in a variety of configurations.
- Wetted parts are nylon and FKM.
- Maximum operating pressure of up to 20 bar depending on the ChemSaver used.
- Flow rating of up to 10.4 l/min at 0.34 bar pressure drop and 15.1 l/min at 0.7 bar pressure drop depending on ChemSaver used.
- See pages 134–135 for additional info on ChemSaver shutoffs.



## SAMPLE VALVE PART NUMBER

LEFT
RIGHT  
**QJS-YN-20MM-SE-SM**

ORIENTATION	
F	Bottom Inlet with Flow Meter
H	Bottom Inlet High Strength
N	Bottom Inlet
R	Side Inlet High Strength
X	Bottom Inlet High Strength with Flow Meter

PIPE SIZE	
20 mm	20 mm Tubing
25 mm	25 mm Tubing
28 mm	28 mm Tubing
1/2	1/2" Pipe
3/4	3/4" Pipe
1	1" Pipe

OUTLETS & SHUTOFF TYPE	
C	Standard ChemSaver®
M	Manual ChemSaver
E	12V e-ChemSaver
V	24V e-ChemSaver
A	Air ChemSaver
X	No ChemSaver
P	QJS End Cap
SC	Side Body End Cap
SM	Side Body with Manual ChemSaver
SE	Side Body e-ChemSaver 12V
SV	Side Body e-ChemSaver 24V
SA	Side Body Air ChemSaver
SX	Side Body ChemSaver
BLANK	None

BOOM COMPONENTS

### QJ370

- Available with 3 or 5 spray positions for easy change of spray tips or quick boom flushing.
- Positive shutoff between each position.
- Automatic spray alignment using flat fan spray tips.
- Maximum operating pressure of 20 bar.
- Bottom or side inlet in six different boom diameters: ½", ¾", 1", 20 mm, 25 mm, and 28 mm.
- Includes ChemSaver® diaphragm check valve for drip-free shutoff. Standard diaphragm opens at 0.7 bar. See page 135 for additional 21950 ChemSaver® spring capacities.
- Standard FKM diaphragm and O-rings.
- Also available with optional Air ChemSaver® or e-ChemSaver shutoff valves, see pages 134–135 for additional information.
- QJ373 Flow Rate: 9.8 l/min at 0.34 bar pressure drop; 13.6 l/min at 0.7 bar pressure drop.

- QJ375 Flow Rate: 9.1 l/min at 0.34 bar pressure drop; 12.9 l/min at 0.69 bar pressure drop.
- Mounts to a 9.5 mm hole drilled in pipe or tubing (7 mm inlet option available on ½" size).
- Molded hex socket in upper clamp for attaching to flat surfaces. Accepts ⅝" or M8 bolt.
- Hinged upper clamp reduces assembly time and fits inside common boom channels.
- Notched inlet tube allows for more complete boom drainage and reduces sediment buildup.

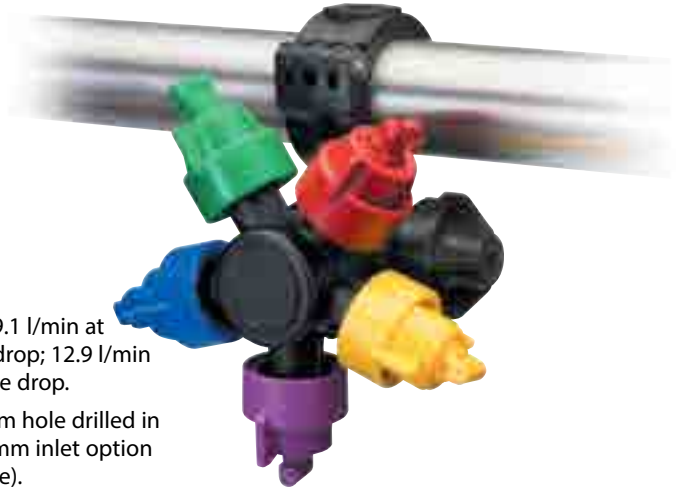

### QJ373

PART NUMBER	NUMBER OF SPRAY OUTLETS	TO CLAMP ON
QJ373-20MM-NYB	3	20 mm Tubing
QJ373-25MM-NYB	3	25 mm Tubing
QJ373-28MM-NYB	3	28 mm Tubing
QJ373-1/2-NYB	3	½" Pipe
QJ373-1/2-6MM-NYB	3	½" Pipe
QJ373-3/4-NYB	3	¾" Pipe
QJ373-1-NYB	3	1" Pipe

**Note:** QJ370 bodies are available with the check valve on the left side (as viewed with plug facing you). Add -L after the QJ373 in the part number. Example: QJ373-L-1-NYB.



QJ373

### QJ375

PART NUMBER	NUMBER OF SPRAY OUTLETS	TO CLAMP ON
QJ375-20MM-NYB	5	20 mm Tubing
QJ375-25MM-NYB	5	25 mm Tubing
QJ375-28MM-NYB	5	28 mm Tubing
QJ375-1/2-NYB	5	½" Pipe
QJ375-1/2-6MM-NYB	5	½" Pipe
QJ375-3/4-NYB	5	¾" Pipe
QJ375-1-NYB	5	1" Pipe

**Note:** QJ370 bodies are available with the check valve on the left side (as viewed with plug facing you). Add -L after the QJ375 in the part number. Example: QJ375-L-1-NYB.



QJ375

### QJ360C SERIES

- Available with either 3, 4 or 5 spray positions for easy change of spray tips or quick boom flushing.
- Positive shutoff between each position.
- Automatic spray alignment using flat fan spray tips.
- Maximum operating pressure of 20 bar.
- Available to fit 25mm tubing, ½", ¾", and 1" pipe.
- Includes ChemSaver® diaphragm check valve for drip-free shutoff. Standard diaphragm opens at 0.7 bar. See page 135 for additional 21950 ChemSaver spring capacities.
- Standard EPDM diaphragm with FKM available as an option.
- Also available with optional Air ChemSaver or e-ChemSaver shutoff valves, see pages 134–135 for additional information.
- Flow Rate: 8.5 l/min at 0.34 bar pressure drop, 12.0 l/min with 0.69 bar pressure drop.



### QJ360E SERIES

- Mounts to a 9.5 mm hole drilled in pipe or tubing (7 mm inlet option available on ½" size).
- Molded hex socket in upper clamp for attaching to flat surfaces. Accepts ⅝" or M8 bolt.
- Hinged upper clamp reduces assembly time and fits inside common boom channels.
- Available to fit 20 mm O.D. tubing only.
- Flow Rate: 5.7 l/min at 0.34 bar pressure drop, 8.0 l/min with 0.69 bar pressure drop.
- Reduced internal cavity to increase ChemSaver shut-off speed.
- Notched inlet tube allows for more complete boom drainage and reduces sediment buildup.



QJ363C  
QJ363E



QJ364C  
QJ364E



QJ365C  
QJ365E

### QJ363

PART NUMBER	NUMBER OF SPRAY OUTLETS	TO CLAMP ON
QJ363E-20MM-NYB	3	20 mm Tubing
QJ363C-25MM-NYB	3	25 mm Tubing
QJ363C-1/2-NYB	3	½" Pipe
QJ363C-1/2-6MM-NYB	3	½" Pipe
QJ363C-3/4-NYB	3	¾" Pipe
QJ363C-1-NYB	3	1" Pipe

### QJ364

PART NUMBER	NUMBER OF SPRAY OUTLETS	TO CLAMP ON
QJ364E-20MM-NYB	4	20 mm Tubing
QJ364C-25MM-NYB	4	25 mm Tubing
QJ364C-1/2-NYB	4	½" Pipe
QJ364C-1/2-6MM-NYB	4	½" Pipe
QJ364C-3/4-NYB	4	¾" Pipe
QJ364C-1-NYB	4	1" Pipe

### QJ365

PART NUMBER	NUMBER OF SPRAY OUTLETS	TO CLAMP ON
QJ365E-20MM-NYB	5	20 mm Tubing
QJ365C-25MM-NYB	5	25 mm Tubing
QJ365C-1/2-NYB	5	½" Pipe
QJ365C-1/2-6MM-NYB	5	½" Pipe
QJ365C-3/4-NYB	5	¾" Pipe
QJ365C-1-NYB	5	1" Pipe



### QJ370

- Available with 3 or 5 spray positions for easy change of spray tips or quick boom flushing.
- Positive shutoff between each spray position.
- Automatic spray alignment using flat fan spray tips.
- Maximum operating pressure of 20 bar.
- Available in three sizes: ½", ¾", 1" single or double hose shanks.
- Includes ChemSaver® diaphragm check valve for drip-free shutoff. Standard diaphragm opens at 0.7 bar. See page 135 for additional 21950 ChemSaver spring capacities.
- Standard FKM diaphragm and O-rings.
- Also available with optional Air ChemSaver or e-ChemSaver shutoff valves, see pages 134–135 for additional information.
- Durable design mounts body high on boom structure for maximum protection.
- QJ373 Flow Rate: 9.8 l/min at 0.34 bar pressure drop; 13.6 l/min at 0.7 bar pressure drop.
- QJ375 Flow Rate: 9.1 l/min at 0.34 bar pressure drop; 12.9 l/min at 0.69 bar pressure drop.
- Molded hex socket in upper clamp for attaching to flat surfaces. Accepts ⅝" or M8 bolt. Optional upper clamp for M6 bolt.



### QJ373

PART NUMBER			NUMBER OF SPRAY OUTLETS	TO FIT HOSE I.D.
SINGLE LEFT HAND	SINGLE RIGHT HAND	DOUBLE		
QJ373-500-1-NYB	QJ373-500-1R-NYB	QJ373-500-2-NYB	3	½"
QJ373-750-1-NYB	QJ373-750-1R-NYB	QJ373-750-2-NYB	3	¾"
QJ373-1000-1-NYB	QJ373-1000-1R-NYB	QJ373-1000-2-NYB	3	1"



QJ373

### QJ375

PART NUMBER			NUMBER OF SPRAY OUTLETS	TO FIT HOSE I.D.
SINGLE LEFT HAND	SINGLE RIGHT HAND	DOUBLE		
QJ375-500-1-NYB	QJ375-500-1R-NYB	QJ375-500-2-NYB	5	½"
QJ375-750-1-NYB	QJ375-750-1R-NYB	QJ375-750-2-NYB	5	¾"
QJ375-1000-1-NYB	QJ375-1000-1R-NYB	QJ375-1000-2-NYB	5	1"

**Note:** For M6 hex in upper clamp specify -6 in part number. Example: QJ375-750-2-6-NYB



QJ375

### QJ360C SERIES

- Available with either 3, 4 or 5 spray positions for easy change of spray tips or quick boom flushing.
- Positive shutoff between each spray position.
- Automatic spray alignment using flat fan spray tips.
- Maximum operating pressure of 20 bar.
- Available to fit ½", ¾", and 1" pipe single or double hose shanks.
- Includes ChemSaver® diaphragm check valve for drip-free shutoff. Standard diaphragm opens at 0.7 bar. See page 135 for additional 21950 ChemSaver spring capacities.
- Standard EPDM diaphragm with FKM available as an option.
- Also available with optional Air ChemSaver or e-ChemSaver shutoff valves, see pages 134–135 for additional information.



- Durable design mounts body high on boom structure for maximum protection.
- Flow Rate: 8.5 l/min with 0.34 bar pressure drop, 12.0 l/min with 0.69 bar pressure drop.
- Molded hex socket in upper clamp for attaching to flat surfaces. Accepts ⅝" or M8 bolt.
- Hinged upper clamp reduces assembly time and fits inside common boom channels.

### QJ363C

PART NUMBER		NUMBER OF SPRAY OUTLETS	TO FIT HOSE I.D.
SINGLE	DOUBLE		
QJ363C-500-1-NYB	QJ363C-500-2-NYB	3	½"
QJ363C-750-1-NYB	QJ363C-750-2-NYB	3	¾"
QJ363C-1000-1-NYB	QJ363C-1000-2-NYB	3	1"



QJ363C

### QJ364C

PART NUMBER		NUMBER OF SPRAY OUTLETS	TO FIT HOSE I.D.
SINGLE	DOUBLE		
QJ364C-500-1-NYB	QJ364C-500-2-NYB	4	½"
QJ364C-750-1-NYB	QJ364C-750-2-NYB	4	¾"
QJ364C-1000-1-NYB	QJ364C-1000-2-NYB	4	1"



QJ364C

### QJ365C

PART NUMBER		NUMBER OF SPRAY OUTLETS	TO FIT HOSE I.D.
SINGLE	DOUBLE		
QJ365C-500-1-NYB	QJ365C-500-2-NYB	5	½"
QJ365C-750-1-NYB	QJ365C-750-2-NYB	5	¾"
QJ365C-1000-1-NYB	QJ365C-1000-2-NYB	5	1"



QJ365C

BOOM COMPONENTS

## MULTIPLE NOZZLE BODIES WITH FERTILIZER OUTLETS FOR WET BOOMS

- Single fertilizer nozzle outlet with shutoff cap and either 3, 4 or 5 spray positions for easy change of spray tips or quick boom flushing.
- Positive shutoff between each position.
- Automatic self-alignment with flat fan spray patterns.
- Flow rate: 8.5 l/min with 0.34 bar pressure drop through turret and 12.9 l/min through fertilizer outlet. 12.0 l/min with 0.69 bar pressure drop through turret and 18.2 l/min through fertilizer outlet.
- Maximum pressure of 20 bar.
- Available in 25 mm pipe connections and mounts with a 9.5 mm hole drilled in pipe or tubing.
- Includes ChemSaver® diaphragm check valve for drip-free shutoff. Standard diaphragm opens at 0.7 bar. See page 135

for additional 21950 ChemSaver spring capacities.

- Standard O-rings and diaphragm made of EPDM and Buna with FKM optional.
- Also available with optional Air ChemSaver or e-ChemSaver shutoff valves, see pages 134–135 for additional information.
- Molded hex socket in the upper clamp for attaching to flat surfaces. Accepts 5/16" or M8 bolt.
- Hinged upper clamp reduces assembly time and fits inside common boom channels.

PART NUMBER	NUMBER OF SPRAY OUTLETS	TO CLAMP ON
QJ363F-1-NYB	3 + 1	1" Pipe
QJ364F-1-NYB	4 + 1	1" Pipe
QJ365F-1-NYB	5 + 1	1" Pipe



## MULTIPLE NOZZLE BODIES FOR WET BOOMS

### QC360 QUICK TEEJET NOZZLE BODY WITH CAM COUPLING ADAPTER

- Same features as QJ360C multiple nozzle bodies.
- Body designed to fit into standard cam lever couplings allowing for quick change to smaller capacity spray tips.
- Locating nib keeps body properly oriented in fitting.

- Flow Rate: 8.5 l/min at 0.34 bar pressure drop, 12.0 l/min at 0.69 bar pressure drop.
- 32 mm diameter tip body fits 3/4" cam lever coupling.

PART NUMBER	NUMBER OF SPRAY OUTLETS
QC363-NYB	3
QC364-NYB	4
QC365-NYB	5



## MULTIPLE NOZZLE BODIES WITH FERTILIZER OUTLETS FOR DRY BOOMS

- Single fertilizer nozzle outlet with shutoff cap and either 3, 4, or 5 spray positions for easy change of spray tips or quick boom flushing.
- Positive shutoff between each position.
- Automatic self-alignment with flat fan spray patterns.
- Flow rate: pressure drop of 0.5 bar for 8.5 l/min through turret and 12 l/min through fertilizer outlet.
- Flow rate: pressure drop of 0.69 bar for 12 l/min through turret and 18 l/min through fertilizer outlet.
- Maximum pressure of 20 bar.
- Available in 25 mm single or double hose shanks.
- Includes ChemSaver diaphragm check valve for drip-free shutoff. Standard diaphragm

opens at 1 bar. See page 135 for additional 21950 ChemSaver spring capacities.

- Standard O-rings and diaphragm made of EPDM and Buna with FKM optional.
- Molded hex socket in the upper clamp for attaching to flat surfaces (does not use dry boom clamp). Accepts 5/16" or M8 bolt.
- Also available with optional Air ChemSaver or e-ChemSaver® shutoff valves, see pages 134–135 for additional information.

- Hinged upper clamp reduces assembly time and fits inside common boom channels.

PART NUMBER		NUMBER OF SPRAY OUTLETS	TO FIT HOSE I.D.
SINGLE	DOUBLE		
QJ363F-1000-1-NYB	QJ363F-1000-2-NYB	3 + 1	1"
QJ364F-1000-1-NYB	QJ364F-1000-2-NYB	4 + 1	
QJ365F-1000-1-NYB	QJ365F-1000-2-NYB	5 + 1	

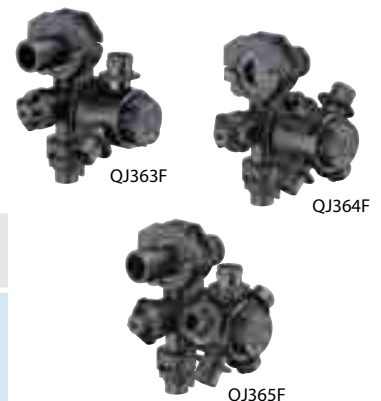



QJ380

### QJ380 HIGH-FLOW NOZZLE BODY

- High-capacity multiple outlet nozzle body is ideal for high speed, high volume applications including liquid fertilizer.
- Available with three spray positions for easy change of spray tips or quick boom flushing.
- Positive shutoff between each spray position.
- Automatic spray alignment when using flat fan spray tips.
- Maximum operating pressure of 10 bar.
- Available in 3/4" or 1" pipe size.
- Requires 9.5 mm hole drilled in pipe or tubing.
- Includes high capacity ChemSaver® diaphragm check valve for drip-free shutoff. Diaphragm opens at 0.8 bar.
- 11.4 l/min flow rate at a 0.34 bar pressure drop.



- Molded hex socket in upper clamp for attaching to flat surfaces. Accepts 5/16" or M8 bolt.
- Hinged upper clamp reduces assembly time and fits inside common boom channels.
- Constructed of nylon and acetal with FKM seals and O-rings.

PART NUMBER	NUMBER OF SPRAY OUTLETS	TO CLAMP ON
QJ383-3/4-NYB	3	3/4" Pipe
QJ383-1-NYB	3	1" Pipe



QJ383F

### QJ380F HIGH-FLOW NOZZLE BODY WITH FERTILIZER OUTLET

- Same features as standard QJ380, with an additional higher flow outlet on bottom of body.
- Additional outlet can be used for very high flow applications such as liquid fertilizer.
- Flow rate through fertilizer outlet is 17.0 l/min at 0.34 bar pressure drop.



PART NUMBER	NUMBER OF SPRAY OUTLETS	TO CLAMP ON
QJ383F-3/4-NYB	3 + 1	3/4" Pipe
QJ383F-1-NYB	3 + 1	1" Pipe



CP98488-VI

### CP98488-VI HI-FLOW NOZZLE BODY ADAPTER INSERT

- Reduces 17.5 mm wet boom inlet hole to 9.5 mm.
- Allows QJ380 nozzle body to be used in place of non-TeeJet high-flow wet boom nozzle bodies.



QJ7421

**QJ7421-NYB**

- Can be mounted to ½", ¾" or 1" pipe or equivalent size tubing.
- ½" and ¾" sizes include a mounting hole in upper clamp subassembly for mounting to flat surfaces.
- Mounts to a 9.5 mm hole drilled in pipe or tubing.
- Maximum operating pressure of 20 bar.

PART NUMBER	TO CLAMP ON	DRILL HOLE SIZE	UPPER CLAMP BOLT SIZE
QJ7421-1/2-NYB	½" Pipe	9.5 mm	¼"
QJ7421-3/4-NYB	¾" Pipe	9.5 mm	¼"
QJ7421-1-NYB	1" Pipe	9.5 mm	N/A



QJ17560A

**QJ17560A-NYB**

- Can be mounted to 20 mm, 25 mm, ½", ¾" or 1" pipe or equivalent size tubing.
- Features ChemSaver drip-free shutoff. Requires 0.7 bar at the nozzle to open check valve.
- Standard diaphragm of EPDM with optional FKM available.
- Mounts to a 9.5 mm or 7.0 mm hole drilled in pipe or tubing.
- All sizes include a mounting hole in upper clamp subassembly for mounting to flat surfaces.
- Maximum operating pressure of 20 bar.
- Flow rate: 8.5 l/min at 0.34 bar pressure drop, 12.0 l/min at 0.69 bar pressure drop.

PART NUMBER	TO CLAMP ON	DRILL HOLE SIZE	UPPER CLAMP BOLT SIZE
QJ17560A-20mm-NYB	20 mm Tubing	9.5 mm	⅝" or M8
QJ17560A-20mmx7-NYB	20 mm Tubing	7.0 mm	⅝" or M8
QJ17560A-25mm-NYB	25 mm Tubing	9.5 mm	⅝" or M8
QJ17560A-1/2-NYB	½" Pipe	9.5 mm	⅝" or M8
QJ17560A-1/2x7-NYB	½" Pipe	7.0 mm	⅝" or M8
QJ17560A-3/4-NYB	¾" Pipe	9.5 mm	⅝" or M8
QJ17560A-1-NYB	1" Pipe	9.5 mm	⅝" or M8



QJ22187

**QJ22187-NYB**

- Can be mounted to ½", ¾" or 1" pipe or equivalent size tubing.
- ½" and ¾" sizes include a mounting hole in clamp subassembly for mounting to flat surfaces.
- Allows side mounting to flat surface for protection of nozzle body.
- Features ChemSaver® drip-free shutoff. Requires 0.7 bar at the nozzle to open check valve.
- Standard diaphragm of EPDM with optional FKM available.
- Mounts to a 9.5 mm hole drilled in pipe or tubing.
- Maximum operating pressure of 20 bar.
- Flow rate: 9.5 l/min at 0.34 bar pressure drop, 13.4 l/min at 0.69 bar pressure drop.

PART NUMBER	TO CLAMP ON	DRILL HOLE SIZE	UPPER CLAMP BOLT SIZE
QJ22187-1/2-NYB	½" Pipe	9.5 mm	¼"
QJ22187-3/4-NYB	¾" Pipe	9.5 mm	¼"
QJ22187-1-NYB	1" Pipe	9.5 mm	N/A



## QJ100 SERIES

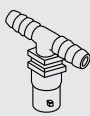
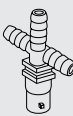

- Hose barb sizes for 3/8", 1/2" and 3/4" I.D. hose.
- Maximum operating pressure of 9 bar.

PART NUMBER SINGLE		PART NUMBER DOUBLE		PART NUMBER TRIPLE		TO FIT HOSE I.D.
	18635-111-406-NYB		18636-112-406-NYB		18637-113-406-NYB	3/8"
	18638-111-540-NYB		18639-112-540-NYB		18640-113-540-NYB	1/2"
	18719-111-785-NYB		18720-112-785-NYB		18721-113-785-NYB	3/4"

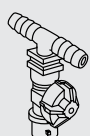

## QJ200 SERIES DIAPHRAGM CHECK VALVE

- Available with single, double or triple hose shanks for 3/8", 1/2" and 3/4" I.D. hose.
- Drip-free shutoff with TeeJet ChemSaver®. Opens at 0.7 bar. Standard diaphragm is EPDM with FKM optional.
- Maximum operating pressure of 9 bar.
- Flow rate: 8.5 l/min at 0.34 bar pressure drop, 12.0 l/min at 0.69 bar pressure drop.

PART NUMBER SINGLE		PART NUMBER DOUBLE		PART NUMBER TRIPLE		TO FIT HOSE I.D.
	19349-211-406-NYB		19350-212-406-NYB		19351-213-406-NYB	3/8"
	19349-211-540-NYB		19350-212-540-NYB		19351-213-540-NYB	1/2"
	19349-211-785-NYB		19350-212-785-NYB		19351-213-785-NYB	3/4"



## QJ300 SERIES DIAPHRAGM CHECK VALVE

- Low-profile design allows maximum protection against damage.
- Available with single and double hose shanks for 3/8", 1/2" and 3/4" I.D. hose.
- Drip-free shutoff with TeeJet ChemSaver. Opens at 0.7 bar. Standard diaphragm is EPDM with FKM optional.
- Maximum operating pressure of 20 bar.
- Flow rate: 13.2 l/min at 0.34 bar pressure drop, 18.5 l/min at 0.69 bar pressure drop.
- QJ300 Series is also available in polypropylene. Maximum operating pressure is 10 bar.

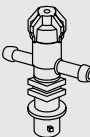
PART NUMBER SINGLE		PART NUMBER DOUBLE		TO FIT HOSE I.D.
	22251-311-375-NYB		22252-312-375-NYB	3/8"
	22251-311-500-NYB		22252-312-500-NYB	1/2"
	22251-311-750-NYB		22252-312-750-NYB	3/4"



Note: See page 132 for vari-spacing clamps. See page 118 for Quick TeeJet caps.

## QJ39685 SERIES

- Use with Quick TeeJet caps.
- Hose shanks available in double or single (left or right) for 1/2" hose I.D.
- TeeJet ChemSaver drip-free shutoff.
- Made of corrosion-resistant materials.
- Maximum operating pressure of 20 bar.
- QJ39684 uses Nylon nut instead of brass nut.



Single Left  
QJ39685-1L-500-NYB



Double  
QJ39685-2-500-NYB



Single Right  
QJ39685-1R-500-NYB





PART NUMBER (PLATED STEEL)	TO FIT
QJ111-1/2	½" Pipe (13/16" & 7/8" O.D. Tubings)
QJ111-3/4	¾" Pipe (1" & 1 1/16" O.D. Tubings)
QJ111-1	1" Pipe (1 1/8", 1 1/4" & 1 3/8" O.D. Tubings)
QJ111-1-1/4	1 ¼" Pipe (1 5/8" & 1 7/8" O.D. Tubings)
QJ111HP-3/4	¾" Pipe (1" & 1 1/16" O.D. Tubings)

PART NUMBER		TO FIT
PLATED STEEL	STAINLESS STEEL	
QJ111SQ-3/4	QJ111SQ-3/4-304SS	¾" Square Tubing
QJ111SQ-1	QJ111SQ-1-304SS	1" Square Tubing
QJ111SQ-1-1/4	QJ111SQ-1-1/4-304SS	1 ¼" Square Tubing
QJ111SQ-1-1/2	QJ111SQ-1-1/2-304SS	1 ½" Square Tubing

## Quick TeeJet®

### MULTIPLE NOZZLE BODY ASSEMBLIES

BOOM COMPONENTS



24230A

#### TRIPLE NOZZLE BODY

- Designed to greatly simplify changing spray tips in the field.
- Provides three spray positions for easy change of spray tips or quick boom flushing.
- Positive shutoff between each spray position.
- Includes ChemSaver® diaphragm check valve for drip-free shutoff. Opens at 0.7 bar.
- Standard EPDM diaphragm with FKM available as an option.
- Can be used with all Quick TeeJet caps.
- Nylon body.
- Maximum operating pressure of 9 bar.
- Available in ½" and ¾" single, double or triple hose shanks.
- Flow Rate: 6.0 l/min at 0.34 bar pressure drop, 8.6 l/min at 0.69 bar pressure drop.

PART NUMBER			TO FIT HOSE
SINGLE	DOUBLE	TRIPLE	
24230A-1-540-NYB	24230A-2-540-NYB	24230A-3-540-NYB	½"
24230A-1-785-NYB	24230A-2-785-NYB	24230A-3-785-NYB	¾"



24216A

#### 24216A-NYB

- Can be mounted to 20 mm, ½", ¾" or 1" pipe or equivalent size tubing.
- Provides three spray positions for easy change of spray tips.
- Shutoff position provided between each spray position.
- Features ChemSaver drip-free shutoff. Requires 0.7 bar at the nozzle to open check valve.
- Standard diaphragm of EPDM with optional FKM available.
- Maximum operating pressure of 10 bar.
- ½" and ¾" sizes include mounting hole in upper clamp subassembly for attachment to flat surfaces.
- Mounts to a 9.5 mm or 7 mm hole drilled in pipe or tubing.
- Flow rate: 6.1 l/min at 0.34 bar pressure drop, 8.6 l/min at 0.69 bar pressure drop.

PART NUMBER	TO CLAMP ON	DRILL HOLE SIZE	UPPER CLAMP BOLT SIZE
24216A-20MM-NYB	20 mm Tubing	9.5 mm	M8
24216A-20MMX7-NYB	20 mm Tubing	7.0 mm	M8
24216A-1/2-NYB	½" Pipe	9.5 mm	¼"
24216A-1/2X7-NYB	½" Pipe	7.0 mm	¼"
24216A-1/2M-NYB	½" Pipe	9.5 mm	M8
24216A-3/4-NYB	¾" Pipe	9.5 mm	¼"
24216A-1-NYB	1" Pipe	9.5 mm	N/A

In this type of nozzle body, the diaphragm check valve is an integral part of the nozzle assembly. This design eliminates the pressure drop associated with ball-type check valves. The spring-backed diaphragm ensures dependable closure. Originally developed for use in aerial spraying, nozzle bodies of this design are now widely used wherever drip-free shutoff is required. For maximum operating pressures of 9 bar.

## Typical Assembly

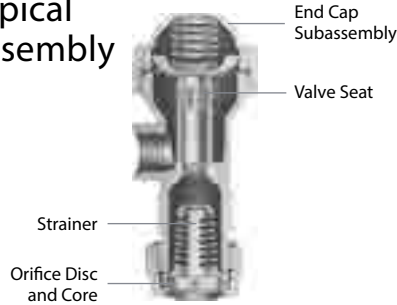

### 8355

Made of Nylon with Nylon/polypropylene end cap assembly. Check valve opens at 0.7 bar pressure. Choice of 1/8" or 1/4" NPT (F) inlet connections. Flow rate for 1/8" is 11.4 l/min at 0.34 bar pressure drop. Flow rate for 1/4" is 15 l/min at 0.34 bar pressure drop. Overall length 70 mm.



### 12328-NYB

Made of Nylon with acetal bonnet. Check valve opens at 0.5 bar pressure. (M) inlet connection and (F) outlet connections. Choice of 1/2" and 3/4" NPT sizes. Flow rate for 1/2" is 45 l/min at 0.34 bar pressure drop. Flow rate for 3/4" is 61 l/min at 0.34 bar pressure drop. Overall length 76 mm.



### 8360

Made of Nylon with Nylon/polypropylene end cap assembly. Check valve opens at 0.7 bar pressure. 1/4" NPT (M) inlet connection. Flow rate of 8.5 l/min at 0.34 bar pressure drop. Overall length 51 mm.



## CHEMSAVER® DIAPHRAGM CHECK VALVE NOZZLE BODIES

Similar in design and performance to the TeeJet Diaphragm Check Valve nozzle bodies, but with pipe thread outlet connections for spray nozzles instead of TeeJet caps and spray tips. For maximum operating pressures of 9 bar.

### 4664B

Made in choice of brass or aluminum. Check valve opens at 0.5 bar pressure. 1/8" NPT (F) inlet connection. Flow rate of 7.5 l/min at 0.34 bar pressure drop. Overall length 59 mm.



### 4666B

Made of brass. 1/8" NPT (F) inlet and outlet connections. Flow rate of 7.5 l/min at 0.34 bar pressure drop. Overall length 49 mm. Check valve opens at 0.5 bar pressure.



### 6140A

Made in choice of brass or aluminum. Check valve opens at 0.5 bar pressure. Choice of 1/4" and 3/8" NPT (F) inlet connections. Outlet connection has dual 1/2" NPT external (M) thread and 3/8" NPT internal (F) thread. Flow rate of 17 l/min at 0.34 bar pressure drop. Overall length 61 mm.



### 6135A

Made in choice of brass or aluminum. Check valve opens at 0.5 bar pressure. Choice of 1/4" and 3/8" NPT (F) inlet connections. Flow rate of 17 l/min at 0.34 bar pressure drop. Overall length 67 mm.



### (B)10742A

Made in choice of brass or aluminum. Check valve opens at 0.5 bar pressure. 1/4" NPT (M) inlet and (F) outlet connections. Overall length 37 mm. Flow rate of 8.5 l/min at 0.34 bar pressure drop.



(B)=BSPT

## 115880 DYNAJET® VALVE

The 115880 e-ChemSaver® is a solenoid actuated shutoff compatible with a wide range of TeeJet nozzle bodies equipped with a diaphragm check valve. It is primarily intended for use with DynaJet or other PWM control systems.

- Valve is normally closed and opens when solenoid is energized.
- Wetted materials include stainless steel and FKM.
- Use with most diaphragm check valve equipped TeeJet nozzle bodies.
- 6.8 bar maximum spraying pressure at minimum voltage (12V or 24V).
- 2.27 l/min at 0.34 bar pressure drop and 3.18 l/min at 0.69 bar pressure drop.
- Offered in 12-Volt or 24-Volt DC version.
- 2-Pin MetriPack connector molded into body for a clean, weather-tight electrical connection.
- Current draw of 0.9 AMPS (10 Watts) at 12-Volt DC.
- Can be ordered with power cable 98552-2 (refer to data sheet DS98552). DS98552 is valid for valves 115880, 116280, and 116950.
- Fluid feed should be filtered through a strainer with 80 mesh or finer screen.



115880

PART NUMBER	VOLTAGE (DC)	FOR USE WITH TEEJET NOZZLE BODY
115880-1-12-*	12	QJ17560A, QJ360E, QJ200, QJ300, 24216A, 24230A, QJ39685, QJP19011, QJ(T)8360, 8360, 13431, PTC Bodies
115880-1-24-*	24	
115880-2-12-*	12	QJ360C, QJ360F, QJ370, QJ22187, QJ8355, 8355
115880-2-24-*	24	
115880-4-12-*	12	QJS
115880-4-24-*	24	
115880-6-12	12	Wilger Nozzle Bodies
115880-6-24	24	
115880-7-12	12	Arag®/Hypro® Nozzle Bodies
115880-7-24	24	

\*Specify cable length in part number: 05 (0.5 m), 15 (1.5 m), 30 (3.0 m), 60 (6.0 m), 200 (20.0 m) or blank (no cable).

## 116280 DYNAJET® HF VALVE

- Designed for PWM applications requiring higher flow rates.
- Maximum rated pressure: 7.0 bar (12V or 24V).
- Flow of 3.4 l/min at 0.34 bar pressure drop.
- Flow of 4.9 l/min at 0.69 bar pressure drop.
- Offered in 12-or 24-Volt DC version.
- Maximum current draw of 1.17 AMPS (14 Watts) at 12 Volts.
- Stainless steel/FKM wetted parts.
- Available to fit most TeeJet nozzle bodies with diaphragm check valves.
- Universal gasket to fit all Quick TeeJet bodies.
- No need for specific nozzle body valve models.



116280



116950

## 116950 E-CHEMSAVER ECOSTOP™ VALVE

- Designed for tip shutoff in individual nozzle control applications.
- Not fast enough for PWM applications.
- Maximum rated pressure: 7.0 bar (12V or 24V).
- Flow of 2.8 l/min at 0.34 bar pressure drop.
- Flow of 4.1 l/min at 0.69 bar pressure drop.
- Offered in 12-or 24-Volt DC version.
- Maximum current draw of 0.47 AMPS (5.6 Watts) at 12 Volts.
- Stainless Steel, FKM, PEEK – interface cap, bobbin.
- Universal gasket to fit all Quick TeeJet bodies.
- No need for specific nozzle body valve models.

### HOW TO ORDER

1 1 5 8 8 0 - 1 - \* - \* \* \*

DynaJet Valve

1 1 6 2 8 0 - \* - \* \* \*

DynaJet High Flow Valve

1 1 6 9 5 0 - \* - \* \* \*

e-ChemSaver ES Valve

\* Voltage

\*\* Cable length

- Convenient multi-tool design is a must have for any sprayers equipped with e-ChemSaver tip shutoffs or DynaJet Valves.
- Designed for easy installation, removal, and disassembly of e-ChemSaver tip shutoffs and DynaJet valves.
- Also allows for Quick TeeJet cap installation and removals and orientation of various threaded nozzles and spray tips.
- Nylon construction for good strength and wear life.



CP116231-NYB

# TeeJet® NOZZLE BODY SHUTOFF VALVES

## 55300 AIR CHEMSAVER® SHUTOFF

55300 ChemSaver Air Shutoff Valve is designed as a pneumatic valve for use on Quick TeeJet® nozzle assemblies. Air pressure is used to open the valve and a spring is used to close the valve.

- Wetted materials include polypropylene, Kynar® and FKM.
- 3.1 bar minimum air pressure.
- 10 bar maximum liquid pressure.
- Air inlet fitting swivels around body and accepts 6 mm push-to-connect fittings for fast installation.
- Valve is normally closed.
- Very low air consumption per cycle reduces load on air supply system.
- 55300-1 is for use with QJS series nozzle bodies.



55300



58140

## 58140 CHEMSAVER MANUAL SHUTOFF

- Use with any application where individual shutoff is important such as golf course and estate sprayers.
- Fits any Quick TeeJet nozzle body with diaphragm check valve.
- With retaining ring in fully open position (turn counterclockwise), functions like a standard 0.7 bar diaphragm check valve.
- With retaining ring in fully closed position (turn clockwise), all flow through nozzle body is shut off.
- 10 bar maximum pressure rating.
- Nylon construction.

### HOW TO ORDER

5 5 3 0 0 or 5 5 3 0 0 - 1

Air ChemSaver Shutoff

5 8 1 4 0 - N Y B

Manual ChemSaver Shutoff

# TeeJet® NOZZLE BODY CHEMSAVER® CHECK VALVES

CHEMSAVER DIAPHRAGM CHECK VALVES	EXPLODED VIEW																	
<p>Back end of Diaphragm Check Valves (Brass)</p>	<p><b>CP6227-TEF</b> Diaphragm PTFE (optional) To be used with 4620 Diaphragm</p>	<p><b>CP4620-FA</b> Diaphragm Fairprene® or FKM</p>	<p><b>9758</b> End Cap Subassembly Brass, Aluminum</p>	<p><b>CP4624</b> Retainer Brass, Aluminum</p>														
<p>Back end of Diaphragm Check Valves (Nylon)</p>	<p><b>CP6227-TEF</b> Diaphragm PTFE (optional) To be used with 4620 Diaphragm</p>	<p><b>CP21953-EPR*</b> Diaphragm EPDM or FKM</p>	<p><b>21950-*-NYB</b> ChemSaver End Cap Assembly Nylon/ Polypropylene</p>	<table border="1"> <thead> <tr> <th>PART NUMBER</th> <th>APPROXIMATE OPENING PRESSURE</th> </tr> </thead> <tbody> <tr> <td><b>21950-2-NYB</b></td> <td>0.14 bar</td> </tr> <tr> <td><b>21950-5-NYB</b></td> <td>0.34 bar</td> </tr> <tr> <td><b>21950-8-NYB</b></td> <td>0.6 bar</td> </tr> <tr> <td><b>21950-10-NYB</b></td> <td>0.7 bar</td> </tr> <tr> <td><b>21950-15-NY</b></td> <td>1 bar</td> </tr> <tr> <td><b>21950-20-NYB</b></td> <td>1.4 bar</td> </tr> </tbody> </table>	PART NUMBER	APPROXIMATE OPENING PRESSURE	<b>21950-2-NYB</b>	0.14 bar	<b>21950-5-NYB</b>	0.34 bar	<b>21950-8-NYB</b>	0.6 bar	<b>21950-10-NYB</b>	0.7 bar	<b>21950-15-NY</b>	1 bar	<b>21950-20-NYB</b>	1.4 bar
PART NUMBER	APPROXIMATE OPENING PRESSURE																	
<b>21950-2-NYB</b>	0.14 bar																	
<b>21950-5-NYB</b>	0.34 bar																	
<b>21950-8-NYB</b>	0.6 bar																	
<b>21950-10-NYB</b>	0.7 bar																	
<b>21950-15-NY</b>	1 bar																	
<b>21950-20-NYB</b>	1.4 bar																	
<p>QJS</p>	<p><b>CP56709-VI</b> EPDM also available</p>	<p><b>56714-NYB</b> End Cap Subassembly</p>	<p><b>CP56711-NYB</b> Retaining Ring</p>															



QJ8360-NYB



QJT8360-NYB  
QJP19011-NYB

### QJT8360-NYB, QJP19011-NYB & QJ8360-NYB

- Retrofits to a Quick TeeJet system.
- Features ChemSaver® no-drip shutoff. Requires 0.7 bar at the nozzle to open check valve.
- Standard diaphragm of EPDM with optional FKM available upon request.
- Maximum operating pressure of 20 bar.
- Flow rate: 8.5 l/min at 0.34 bar pressure drop, 12.0 l/min at 0.69 bar pressure drop.

PART NUMBER	INLET
QJ(B)8360-NYB	¼" (M) Thread
QJT8360-NYB	1½"-16 (F) TeeJet Thread
QJP19011-NYB	¾" (F) BSPP Thread
QJ8360-1/4F-NYB	¼" (F) Thread

(B)=BSPT

### QJ8355-NYB

- Allows use of Quick TeeJet system with ⅛" and ¼" NPT female connections.
- Side mounting provides protection of the nozzle body.
- Features no-drip shutoff. Requires 0.7 bar at the nozzle to open check valve.
- Standard diaphragm of EPDM with optional FKM available upon request.
- Maximum operating pressure of 20 bar.
- Flow rate: 8.5 l/min at 0.34 bar pressure drop, 12.0 l/min at 0.69 bar pressure drop.



PART NUMBER	INLET
QJ8355-1/8-NYB	⅛" (F)
QJ8355-1/4-NYB	¼" (F)

### QJ1/4TT-NYB

- Allows use of Quick TeeJet system with ¼" NPT and BSPT male connections.
- Maximum operating pressure of 20 bar.



PART NUMBER	INLET
QJ(B)1/4TT-NYB	¼" (M) Thread

(B)=BSPT

### QJ1/4T-NYB & QJT-NYB

- QJ1/4T-NYB allows use of Quick TeeJet system with ¼" NPT and BSPT female connections.
- QJT-NYB permits use of Quick TeeJet system with standard 1½"-16 TeeJet thread.
- Maximum operating pressure of 20 bar.



PART NUMBER	INLET
(B)QJ1/4T-NYB	¼" (F) Thread
QJT-NYB	1½"-16 (F) TeeJet Thread

(B)=BSPT

### 22674-1/4-NYB

- Allows use of Quick TeeJet system with ¼" NPT or BSPT male connections.



PART NUMBER	INLET
(B) 22674-1/4-NYB	¼" (M) Thread

(B)=BSPT



## QJ90-1-NYR

- Fits standard Quick TeeJet® bodies.
- Nylon body construction for strength and durability, with EPDM gasket (FKM optional).
- Outlet can be fitted with Quick TeeJet caps and TeeJet spray tips.
- One piece, 90° elbow is ideal for installation of TK-VS FloodJet® and TF-VS or TF-VP Turbo FloodJet® nozzles on single or multiple outlet nozzle bodies. Proper orientation of spray tip enhances spray distribution quality.
- Adapter outlet accepts standard tip strainers.



## QJ90-2-NYR

- Fits standard Quick TeeJet bodies.
- Made of Nylon with CP19438-EPR gasket (included).
- Use with Quick TeeJet cap and gasket for automatic alignment when using flat fan spray tips.
- 90° included angle between outlets. When used with standard flat fan tips produces a twin type spray pattern for improved coverage and canopy penetration.



## 50854-NYB

- For use with Quick TeeJet nozzle bodies to extend body length by 2.5 cm.
- Used to eliminate interference of spray pattern with sprayer boom structure or shields, particularly with twin pattern or fertilizer spray tips.
- Nylon body construction with EPDM gasket.



## 55240-CELR

- Converts Hardi® snap-fit nozzle body connection to Quick TeeJet connection for easy installation of TeeJet tips. Especially useful for AIC, XRC, SJ7A, and TT160 tips.
- Acetal construction with EPDM gasket for durability and chemical resistance.
- Accepts standard tip strainers.



## QJ-W-PP

- Converts Wilger nozzle body connection to Quick TeeJet connection.
- Polypropylene construction with Buna O-ring seal.



PART NUMBER	MAXIMUM OPERATING PRESSURE	TO FIT
QJ90-1-NYR	20 bar	Quick TeeJet
QJ90-2-NYR	20 bar	Quick TeeJet
50854-NYB	20 bar	Quick TeeJet
55240-CELR	10 bar	Hardi Snap-Fit
QJ-W-PP	10 bar	Wilger Combo-Jet®
QJ-W-PP-10X	10 bar	Wilger Combo-Jet (Qty. 10)

## CP116232-NY CAP INSTALLATION & REMOVAL TOOL

- Convenient multi-tool design is a must have for all sprayers.
- Designed for easy installation and removal of Quick TeeJet caps, ChemSaver® diaphragm check valves, and orientation of various threaded nozzles and spray tips.
- Reduces operator fatigue when changing out spray tips.



## CP98583 RAPID STOP NOZZLE BODY ADAPTER

- Extended inlet tube for wet boom nozzle bodies raises inlet tube height to evacuate trapped air from spray boom.
- Can significantly reduce the shut off and turn on time of spray tips for more precise application.
- Easily installed into a wide range of TeeJet wet boom nozzle bodies.
- Stainless steel construction for strength and excellent chemical resistance.

PART NUMBER	WET BOOM SIZE	FITS TEEJET NOZZLE BODY
CP98583-2-1/2-SS	½" Pipe	QJ17560A, 24216A
CP98583-2-3/4-SS	¾" Pipe	
CP98583-2-1-SS	1" Pipe	
CP98583-3-1/2-SS	½" Pipe	QJ360C, QJ360F, QJ370, QJ380, QJ380F, QJS
CP98583-3-3/4-SS	¾" Pipe	
CP98583-3-1-SS	1" Pipe	



## 23770-SS ROW APPLICATION KIT

- For applying post-emergence chemicals over crop rows.
- Arms adjustable for length and angle without removing bolts; simply loosen.
- Available with stainless steel arms.
- Positioning one arm at proper angle automatically sets correct angle of second arm.
- Fits square or round booms up to 38 mm diameter.
- Kit includes standard and Quick TeeJet nozzle bodies.
- Side nozzle bodies may be rotated.
- Maximum pressure of 9 bar.
- Spray tips and strainers not included.



Supplied without spray tips and strainers



### STRAIGHT CAP



QJ98588  
QJ115825



QJ114398  
QJ98586

### SWIVEL CAP



QJ114404  
QJ114405



QJ114403

### 90° CAPS



QJ98598



QJ98599

### QUICK TEEJET OUTLET



QJ98590  
QJ114400



QJ98592

### BODY & CAP ASSEMBLY



QJ98594  
QJ114401



QJ98595

### PTC OUTLET BODY



QJ114430  
QJ114432  
QJ114434

- Fittings feature push to connect couplers for fast, easy, leak-free assembly.
- Offered in body, straight cap, 90° fixed cap and 90° swivel cap.
- Accepts plastic and soft metal tubing.
- Commonly used for liquid fertilizer application systems on planters and toolbars.
- Maximum operating pressure of 7 bar.
- Caps include CP18999-EPR gasket.

### HOW TO ORDER

Q J 9 8 5 9 5 - 1 / 4 - \*

PART NUMBER	TUBING SIZE (O.D.)	DESCRIPTION
QJ98595-1/4-*	1/4"	Straight Cap & Body
QJ114401-5/16-*	5/16"	Straight Cap & Body
QJ98594-3/8-*	3/8"	Straight Cap & Body
QJ98592-1/4-*	1/4"	Body
QJ114400-5/16-*	5/16"	Body
QJ98590-3/8-*	3/8"	Body
QJ115825-3/16	3/16"	Straight Cap
QJ98588-1/4	1/4"	Straight Cap
QJ114398-5/16	5/16"	Straight Cap
QJ98586-3/8	3/8"	Straight Cap
QJ98598-90-1/4	1/4"	90° Fixed Cap
QJ98599-90-3/8	3/8"	90° Fixed Cap
QJ114403-1/4	1/4"	90° Swivel Cap
QJ114404-5/16	5/16"	90° Swivel Cap
QJ114405-3/8	3/8"	90° Swivel Cap
QJ114430-1/4-*	1/4"	Capless Body, PTC In & PTC Out
QJ114432-5/16-*	5/16"	Capless Body, PTC In & PTC Out
QJ114434-3/8-*	3/8"	Capless Body, PTC In & PTC Out

\*Specify diaphragm check valve opening pressure.

## 98450 SERIES BRASS ROLLOVER

TeeJet rollovers are designed for use on air blast sprayers in orchard and vineyard spraying applications. These compact rollovers are available with or without diaphragm check valve, offer a choice of single- or double-outlet configurations, and are available with a variety of inlet connection sizes and thread types.

Precision machined forged brass construction makes TeeJet rollovers both rugged and durable.

- Maximum recommended pressure of 52 bar.
- Flow rate of 6.1 l/min with a 0.69 bar pressure drop.
- Two shutoff positions at 90° from open.
- Three open positions at vertical and +/-15° from vertical with positive detent.
- 1/16"-16 outlet thread accepts standard tip retaining caps.

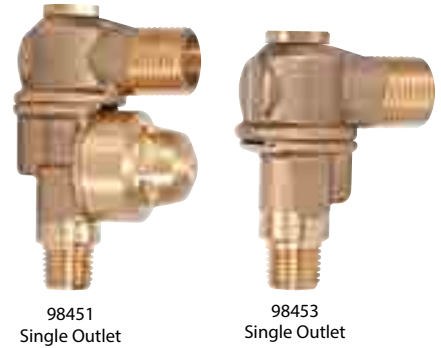

### SAMPLE ROLLOVER PART NUMBER:

B 9 8 4 5 0 - 1 / 4 F

INLET THREAD TYPE	
Blank	NPT
B	BSPT
S	NPS
P	BSPP

Note: NPS & BSPP versions include locking nut on inlet.

MODEL SPECIFICATION	
9845	Rollover

BODY CONFIGURATION	
0	Double Outlet, with Check Valve
1	Single Outlet, with Check Valve
2	Double Outlet, No Check Valve
3	Single Outlet, No Check Valve

INLET THREAD SIZE	
1/4F	1/4" Female
1/4M	1/4" Male
3/8M	3/8" Male

Note: 1/4F not available in NPS or BSPP.

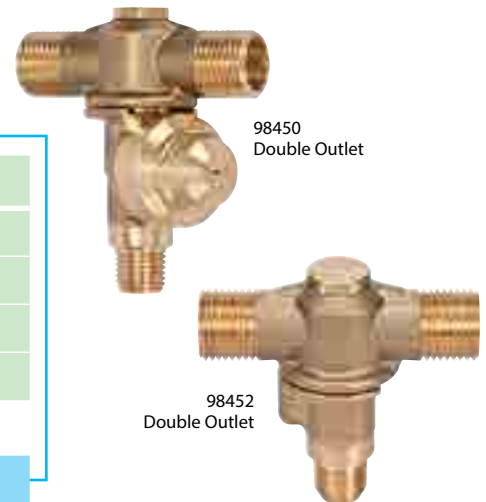

## PLUG VALVE

A compact quarter turn on-off valve for many applications. Low-profile handle is suited for use on airblast sprayers. Maximum operating pressure of 28 bar. Brass with Celcon® handle.

PLUG VALVE NUMBER	CONNECTIONS IN NPT
(B)23220-1/4F x 1/4F	1/4" (F) x 1/4" (F)
(B)23220-1/8F x 1/8F	1/8" (F) x 1/8" (F)
(B)23220-1/4M x T	1/4" (M) x 1/16"-16 (M)
(B)23220-1/4F x T	1/4" (F) x 1/16"-16 (M)
(B)23220-1/4M x 1/4F	1/4" (M) x 1/4" (F)
(B)23220-1/4F x 1/4M	1/4" (F) x 1/4" (M)

(B)=BSPT



### TYPICAL ASSEMBLY WITH CERAMIC DISC AND CORE

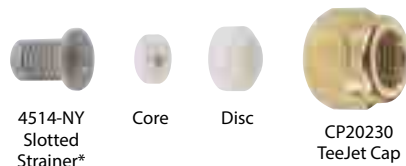

\*Use CP20229-NY gasket when 4514-NY Nylon slotted strainer is not used.

# TeeJet® SWIVEL NOZZLE BODIES

## QUICK TEEJET SWIVEL NOZZLE BODIES

QJ8600 swivel Quick TeeJet® nozzle body assemblies provide the same spray tip adjustability of a standard TeeJet® threaded swivel plus the quick change and self-aligning features of the Quick TeeJet System.

### QJ8600-2-1/4-NYB

Double Swivel Nozzle



PART NUMBER	PIPE THREAD	MATERIAL
QJ8600-2-1/4-NYB	¼" NPT (F)	Nylon

### QJ8600-1/4-NYB

Single Swivel Nozzle



PART NUMBER	PIPE THREAD	MATERIAL
QJ8600-1/4-NYB	¼" NPT (F)	Nylon

## SWIVEL NOZZLE BODIES

TeeJet swivel nozzle bodies are primarily for use with tips employed in row crop spraying. A locknut holds swivel bodies firmly in position at selected spray projection angle so they are not affected by jarring and vibration. For use at pressures up to 9 bar.

### 5000

Single Swivel Nozzle



PART NUMBER	INLET CONNECTION	MATERIAL	SWIVEL ARC RANGE
(B)5000-1/4T	¼" NPT (F)	Brass	280°

### 5540

Single Swivel Nozzle



PART NUMBER	INLET CONNECTION	MATERIAL	SWIVEL ARC RANGE
(B)5540-1/4TT	¼" NPT (M)	Brass	280°

### 4202

Double Swivel Nozzle



PART NUMBER	INLET CONNECTION	MATERIAL	SWIVEL ARC RANGE
4202-2-1/4T	¼" NPT (F)	Brass	280°

### 6240

Double Swivel Nozzle



PART NUMBER	INLET CONNECTION	MATERIAL	SWIVEL ARC RANGE
(B)6240-1/4TT	¼" NPT (M)	Brass	280°

### 7450 COMPACT

Double Swivel Nozzle



PART NUMBER	INLET CONNECTION	MATERIAL	SWIVEL ARC RANGE
(B)7450-2T	¼" NPT (F)	Brass	280°

### 5932

Double Swivel Nozzle ¼" NPT Female Bottom Outlet



PART NUMBER	INLET CONNECTION	MATERIAL	SWIVEL ARC RANGE
5932-2-1/4T	¼" NPT (F)	Brass	280°

### 8600 NYLON

Single Swivel Nozzle



PART NUMBER	INLET CONNECTION	MATERIAL	SWIVEL ARC RANGE
8600-1/4T-NYB	¼" NPT (F)	Nylon	280°

### 8600-2 NYLON

Double Swivel Nozzle



PART NUMBER	INLET CONNECTION	MATERIAL	SWIVEL ARC RANGE
8600-2-1/4T-NYB	¼" NPT (F)	Nylon	280°

### 7620 COMPACT

Single Swivel Nozzle



PART NUMBER	INLET CONNECTION	MATERIAL	SWIVEL ARC RANGE
(B)7620-T	¼" NPT (F)	Brass	360°

## HOW TO ORDER

5 0 0 0 - 1 / 4 T (Brass NPT)

B 5 0 0 0 - 1 / 4 T (Brass BSPT)

**Note:** Swivels do not include tips, strainers or caps.

# TeeJet® HOSE DROPS

Hose drops connect to standard and Quick TeeJet nozzle bodies and can also be used with swivels. Available in 380 mm and 610 mm lengths. Maximum operating pressure of 9 bar.

**Note:** QJ1/4T-NYB can be attached to hose drops for use with Quick TeeJet caps. See page 118 for ordering information.

ITEM	HOSE DROP NUMBER	LENGTH	INLET CONNECTION	OUTLET CONNECTION	MATERIAL
A	21353-6-15-NYB	380 mm	Quick TeeJet Type	¼" NPT (M)	Nylon with Quick TeeJet Cap & EPDM Gasket
	21353-6-24-NYB	610 mm			
B	21354-15-NYB	380 mm	1½"-16 TeeJet Thread		Nylon
	21354-24-NYB	610 mm			

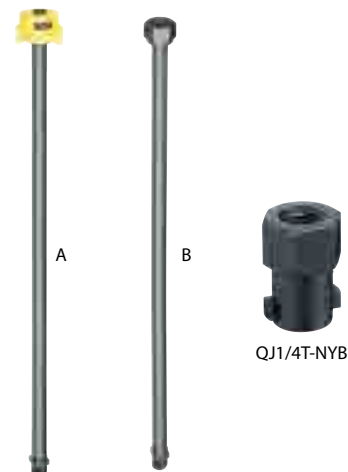

# TeeJet® HOSE SHANK NOZZLE BODIES

## FOR OPERATING PRESSURES UP TO 9 BAR

Brass, stainless steel, Nylon and acetal/ stainless steel hose shank nozzle bodies. Features 1/16"-16 TeeJet threaded outlet. See page 142 for clamp assemblies.

### SINGLE HOSE CONNECTION

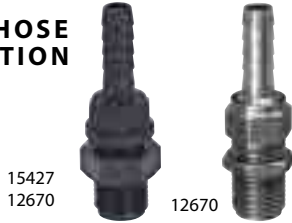

HOSE SHANK BODY ASSEMBLY NUMBER	TO FIT HOSE I.D.	MATERIAL
15427-1-296	1/4"	Brass
12670-406TD-NYB	3/8"	Nylon
12670-406TD-SS	3/8"	Stainless Steel

### SINGLE HOSE CONNECTION



6471B  
8121-NYB  
9191B  
12201-CE

HOSE SHANK BODY ASSEMBLY NUMBER	TO FIT HOSE I.D.	MATERIAL
6471B-400TD	3/8"	Brass
6471-SS-C400TD	3/8"	Stainless Steel
8121-NYB-406TD	3/8"	Nylon
8121-NYB-540TD	1/2"	Nylon
9191B-531TD	1/2"	Brass
9191-SS-C531TD	1/2"	Stainless Steel
12201-CE-785TD	3/4"	Acetal Hose Shank/ Stainless Steel Threaded Outlet
12201-CE-1062TD	1"	Acetal Hose Shank/ Stainless Steel Threaded Outlet

### DOUBLE HOSE CONNECTION



6472B  
8120-NYB  
9192B  
12202-CE

HOSE SHANK BODY ASSEMBLY NUMBER	TO FIT HOSE I.D.	MATERIAL
6472B-400TD	3/8"	Brass
6472-SS-C400TD	3/8"	Stainless Steel
8120-NYB-406TD	3/8"	Nylon
8120-NYB-540TD	1/2"	Nylon
9192B-531TD	1/2"	Brass
9192-SS-C531TD	1/2"	Stainless Steel
12202-CE-785TD	3/4"	Acetal Hose Shank/ Stainless Steel Threaded Outlet
12202-CE-1062TD	1"	Acetal Hose Shank/ Stainless Steel Threaded Outlet

### HOW TO ORDER

1 2 2 0 2 - C E - 1 0 6 2

To order body assembly only, specify hose shank assembly number.

### TRIPLE HOSE CONNECTION



8124-NYB

HOSE SHANK BODY ASSEMBLY NUMBER	TO FIT HOSE I.D.	MATERIAL
8124-NYB-406TD	3/8"	Nylon
8124-NYB-540TD	1/2"	Nylon

# TeeJet® SPLIT EYELET NOZZLE BODIES

## FOR WET BOOMS

- Mounting on 1/2", 3/4" or 1" pipe or tubing.
- 25775-NYB mounts to 9.5 mm hole drilled in pipe or tubing.
- 7421 mounts to 7.2 mm hole drilled in pipe or tubing.
- 25775-NYB and 7421 feature 1/16"-16 TeeJet threaded outlets.
- 25888-NYB features 1/4" (M) NPT threaded outlet.



25775-NYB  
Operating pressures up to 10 bar



7421  
Operating pressures up to 17 bar

SPLIT EYELET ASSEMBLY NUMBER	MATERIAL	TO CLAMP ON
25775-1/2T-NYB 25888-1/2-NYB	Nylon	1/2" Pipe 13/16" O.D. Tubing 7/8" O.D. Tubing
25775-3/4T-NYB 25888-3/4-NYB	Nylon	3/4" Pipe 1" O.D. Tubing 1 1/16" O.D. Tubing
25775-1T-NYB 25888-1-NYB	Nylon	1" Pipe 1 1/4" O.D. Tubing 1 3/8" O.D. Tubing

SPLIT EYELET ASSEMBLY NUMBER	BODY MATERIAL	TO CLAMP ON
7421-1/2T	Brass	1/2" Pipe
7421-1/2T-SS	Stainless Steel	13/16" O.D. Tubing 7/8" O.D. Tubing
7421-1/2T-NYB	Nylon	7/8" O.D. Tubing
7421-3/4T	Brass	3/4" Pipe
7421-3/4T-SS	Stainless Steel	1" O.D. Tubing 1 1/16" O.D. Tubing
7421-3/4T-NYB	Nylon	1 1/16" O.D. Tubing
7421-1T	Brass	1" Pipe
7421-1T-SS	Stainless Steel	1 1/4" O.D. Tubing 1 3/8" O.D. Tubing
7421-1T-NYB	Nylon	1 3/8" O.D. Tubing

### HOW TO ORDER

7 4 2 1 - 1 / 2 T - S S  
2 5 7 7 5 - 1 / 2 T - N Y B  
2 5 8 8 8 - 1 / 2 - N Y B

Specify split eyelet assembly number.

## Standard Parts

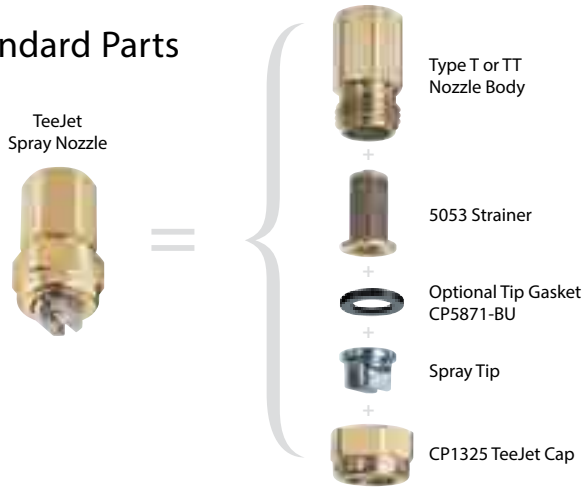

## TEEJET NOZZLE CAPS

Secure interchangeable TeeJet tips to the various nozzle bodies. 18032A-NYB winged TeeJet cap allows quick change of spray tips with no tool required.

TEEJET CAP NUMBER	DESCRIPTION
CP1325	Brass
CP8027-NYB	Nylon
CP8027-1-NYB	Nylon (Extra-Long Size)
CP1325-AL	Aluminum
CP1325-SS	Stainless Steel
CP18032A-NYB	Winged Cap, Nylon
CP3819	Brass (Use with 3/4T & 3/4TT Body)
CP3819-SS	Stainless Steel (Use with 3/4T & 3/4TT Body)
CP20230	Brass (Use with Ceramic Disc-Cores)

## 11750 TEEJET CHECK VALVE

For larger capacity TeeJet nozzles where strainers are not required. Ball check opens at 0.34 bar, 0.7 bar spring also available. Recommended for flow rates from 1.5–5.7 l/min. Made in choice of stainless steel, brass, aluminum or polypropylene with stainless steel ball and spring.



## TEEJET NOZZLE BODIES



### Type-TT

Male Inlet NPT or BSPT Connection

TEEJET BODY NUMBER	FOR TEEJET NOZZLE TYPE	MALE SIZE	MATERIAL
CP(B)1336	1/8TT	1/8"	Brass
CP(B)1322	1/4TT	1/4"	Brass
CP8028-NYB	1/4TT-NYB	1/4"	Nylon
CP(B)1322-I	1/4TT-I	1/4"	Steel
CP(B)1322-SS	1/4TT-SS	1/4"	Stainless Steel
CP(B)1324	3/8TT	3/8"	Brass
CP(B)1340	1/2TT	1/2"	Brass
CP(B)3818	3/4TT	3/4"	Brass
CP(B)3818-SS	3/4TT	3/4"	Stainless Steel

(B) = BSPT



### Type-T

Female Inlet NPT or BSPT Connection

TEEJET BODY NUMBER	FOR TEEJET NOZZLE TYPE	FEMALE SIZE	MATERIAL
CP(B)1335	1/8T	1/8"	Brass
CP(B)1321	1/4T	1/4"	Brass
CP(B)12094-NYB	1/4T-NYB	1/4"	Nylon
CP(B)1321-I	1/4T-I	1/4"	Steel
CP(B)1321-SS	1/4T-SS	1/4"	Stainless Steel
CP(B)1323	3/8T	3/8"	Brass
CP(B)1339	1/2T	1/2"	Brass
CP3817	3/4T	3/4"	Brass
CP3817-SS	3/4T	3/4"	Stainless Steel

(B) = BSPT

## 45° NOZZLE BODY

Ideal for use with FullJet®, FloodJet® and Turbo FloodJet nozzles. Can be used with QJ4676 Quick TeeJet® cap or standard 4676 outlet adapter. Made of polypropylene.



TEEJET BODY NUMBER	INLET	OUTLET
(B)22669-1/4-PPB	1/4" (M)	1 1/16"-16 (M)

(B) = BSPT

## HOW TO ORDER

( B ) 2 2 6 6 9 - 1 / 4 - P P B



AA111



AA111SQ

## CLAMP ASSEMBLIES

Consist of upper and lower clamps and bolt for use with hose shank nozzle bodies.

PART NUMBER	TO CLAMP ON
AA111-1/2	1/2" Pipe (1 3/16" & 7/8" O.D. Tubings)
AA111-3/4	3/4" Pipe (1" & 1 1/16" O.D. Tubings)
AA111-1	1" Pipe (1 1/8", 1 1/4" & 1 3/8" O.D. Tubings)
AA111-1-1/4	1 1/4" Pipe (1 3/8" & 1 11/16" O.D. Tubings)
AA111SQ-1	1" Square Tubing
AA111SQ-1-1/4	1 1/4" Square Tubing
AA111SQ-1-1/2	1 1/2" Square Tubing

## PIPE PLUGS



NUMBER	THREAD	MATERIAL
(B)8400-1/4-PPB	¼" NPT	Polypropylene
8400-1/2-NYB	½" NPT	Nylon
8400-3/4-NYB	¾" NPT	Nylon

(B) = BSPT

## HOW TO ORDER

8 4 0 0 - 3 / 8 - N Y B (Nylon)

Specify part number.

## PLUG TIP



CP3942 plug tip is used to temporarily shut off selected nozzles by replacing spray tips with these plug tips. Quick, easy way to change spacing of nozzles along boom. Materials: brass, aluminum, stainless steel or high-density polyethylene.

## HOW TO ORDER

C P 3 9 4 2 - H D P

Specify part number and material.

## TEEJET® HOSE SHANKS

For attaching hose to nozzle body. Fits all standard TeeJet nozzle caps, replacing spray tips. Type 4251 is available in choice of brass or stainless steel. Type 8400 is made of Nylon.



8400 4251

HOSE SHANK NUMBER	FOR HOSE I.D.	MATERIAL
8400-406-NYB	⅜"	Nylon
8400-500-NYB	½"	Nylon
4251-250	¼"	Brass
4251-250-SS	¼"	Stainless Steel
4251-312	⅝"	Brass
4251-312-SS	⅝"	Stainless Steel
4251-400	⅜"	Brass
4251-400-SS	⅜"	Stainless Steel
4251-437	⅞"	Brass
4251-437-SS	⅞"	Stainless Steel
4251-500	½"	Brass
4251-500-SS	½"	Stainless Steel

## HOW TO ORDER

4 2 5 1 - 2 5 0 (Brass)

Specify hose shank number and material.

## 4676 TEEJET OUTLET ADAPTERS



Fits the outlets of TeeJet nozzle bodies as well as the outlets of various GunJet® spray guns and shutoff valves. Replaces CP1325 TeeJet cap. Used for attaching hose drops to nozzles or extensions to spray guns.

ADAPTER NUMBER	MATERIAL OUTLET CONNECTION	NPT (F)
(B)4676-*	Brass	⅛", ¼", ⅜", ½", ¾"
4676-NYB-*	Nylon	⅛", ¼"
(B)4676-SS-*	Stainless Steel	⅛", ¼", ⅜", ½", ¾"

\*Specify outlet connection.

(B) = BSPT

## HOW TO ORDER

( B ) 4 6 7 6 - S S - 1 / 4 (Stainless Steel)

Specify adapter number and material.

## HOSE SHANK ADAPTERS



8400

CONNECTOR NUMBER	NPT THREAD CONN. (MALE)	FOR HOSE I.D.	MATERIAL
8400-1/4-300-NYB	¼"	¼"	Nylon
8400-1/4-406-NYB	¼"	⅜"	Nylon
8400-1/4-535-NYB	¼"	½"	Nylon
8400-3/8-406-NYB	⅜"	⅜"	Nylon
8400-3/8-535-NYB	⅜"	½"	Nylon
8400-1/2-406-NYB	½"	⅜"	Nylon
8400-1/2-535-NYB	½"	½"	Nylon
8400-1/2-660-NYB	½"	⅝"	Nylon
8400-3/4-535-NYB	¾"	½"	Nylon
8400-3/4-660-NYB	¾"	⅝"	Nylon
8400-3/4-785-NYB	¾"	¾"	Nylon
8400-T-406-NYB TeeJet® Body with hose shank connection	Fits TeeJet® Cap	⅜"	Nylon



13434  
13437

CONNECTOR NUMBER	NPT THREAD CONN.	FOR HOSE I.D.	MATERIAL
13434-406-NYB	¼" (F)	⅜"	Nylon
13437-540-NYB	¼" (F)	½"	Nylon

## HOW TO ORDER

6 0 5 3 - 4 0 0 (Brass)

Specify connector number and material.

## TEEJET OUTLET FITTINGS

These fittings replace spray tips and are used for attaching drop pipes to nozzle bodies or adding extensions to AA23 and AA31 GunJet spray guns and trigger valves.



CP4928

**CP4928 Adapter**—Brass or stainless steel. Length 1", ⅝" NPT female outlet connection.



CP6250

**CP6250 Adapter**—Brass or stainless steel. Length ⅝", ⅛" NPT female outlet connection.



6406

**6406 Adapter**—Brass or stainless steel. Length 1½", ⅛" NPT male outlet connection.

## HOW TO ORDER

C P 4 9 2 8 (Brass)

Specify part number and material.



6053  
6100  
10123-281

CONNECTOR NUMBER	NPT THREAD CONN. (MALE)	FOR HOSE I.D.	MATERIAL
6053-400	¼"	⅜"	Brass
6100-675	¾"	⅝"	Brass
6100-800	¾"	¾"	Brass
10123-1/4-281	¼"	¼"	Brass



13435  
13438

CONNECTOR NUMBER	NPT THREAD CONN.	FOR HOSE I.D.	MATERIAL
13435-406-NYB	¼" (F)	⅜"	Nylon
13438-540-NYB	¼" (F)	½"	Nylon

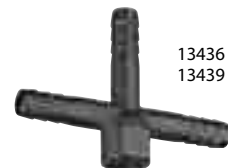

13436  
13439

CONNECTOR NUMBER	NPT THREAD CONN.	FOR HOSE I.D.	MATERIAL
13436-406-NYB	¼" (F)	⅜"	Nylon
13439-540-NYB	¼" (F)	½"	Nylon



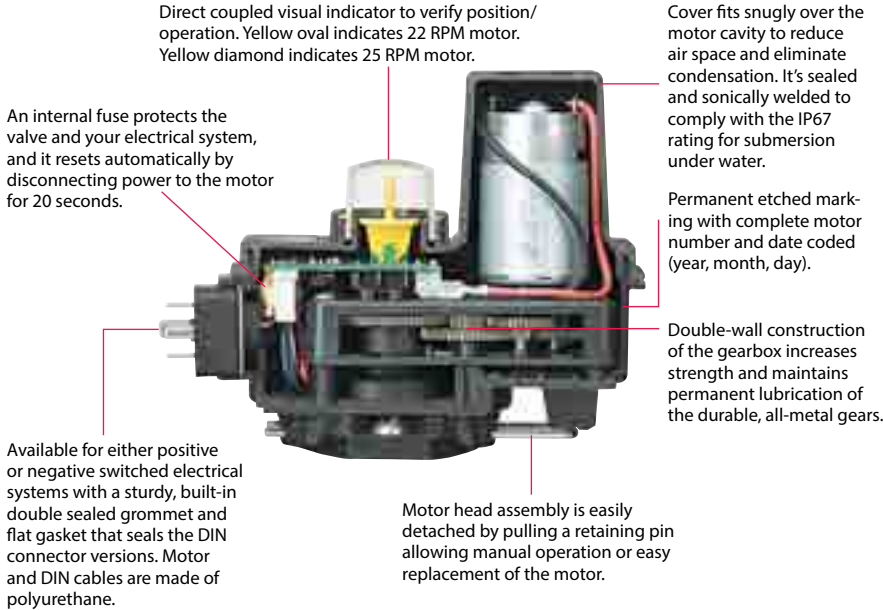

## SHUTOFF/CONTROL MOTORS

Boom Control motors are 22 RPM for 344B series (0.7 second shutoff valves) and 25 RPM for 346B and 356 series (0.6 second shutoff valves) for 12 VDC systems. Available with E or EC series motors with DIN or CABLE versions. E type motors work with DPDT (double pole, double throw) switch. EC type motors work with simple SPST (single pole, single throw) on/off switch and are compatible with all sprayer controls.

Current draw less than 2 AMPS (1.7 AMPS at 40 in-lbs.).

Electrical connectors can be ordered with a standard number. See page 157 for more information.

**Note:** 2-way control motors can be rotated 180° to change the cable outlet direction on the valve. There is also an adapter to rotate motors 90°, contact your local representative for more information.

## REGULATING MOTORS

Choosing the proper regulating motor speed is important to maximizing the sprayer's performance. Three speeds are offered at this time: 1 RPM, 3 RPM and 6 RPM. The 1 RPM speed is used mostly in manual systems; it is too slow for automated rate control. The other two speeds are used in automated systems. The 3 RPM is the most popular and opens the valve to the maximum flow in about 6 seconds for the RL valve and about 10 seconds for the PR valves. The 6 RPM motor cuts those times in half.

## DIN AND CABLE ELECTRICAL CONNECTOR

Both DIN and motor cables are made of polyurethane and are pressure extruded creating a round cable for improved sealing. Polyurethane has twice the strength and three times the tear and abrasion resistance of PVC. Motor cables include over-molded plugs that seal off the ends of cables and wires to prevent seepage. Conductor insulation uses familiar color coding of red, white and black.

DIN cable connectors are constructed of a special over molded elastomeric material that does not require a flat gasket to be sealed. The center screw is made of stainless steel.



## HOW TO ORDER

38082-30, 3 m DIN cable



DIN CABLE	DIN CABLE (m)
38082-05	0.5
38082-15	1.5
38082-30	3
38082-60	6

DIN cables are ordered separately.

### Positively-Switched BEC Shutoff Motors

Positively-Switched Valves are standard

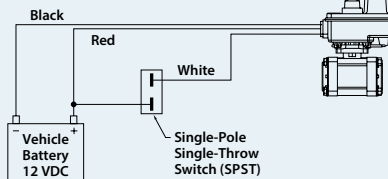

### Negatively-Switched BEC Shutoff Motors

Negatively-Switched Valves are special and are notated by an "N" in the Part Number

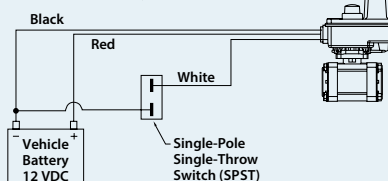

### BE Shutoff and BR Regulating Motors

Includes: BE, BR, BRL & BPR Valve Types

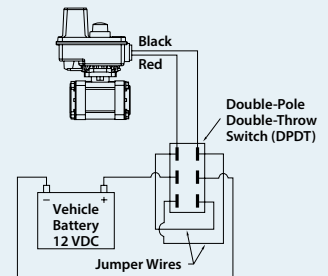

## B STYLE SHUTOFF MOTOR NUMBERS

344B, 440B, 450B, 460B SERIES			CURRENT DRAW (AMPS)**	346B, 356 AND 490 SERIES			CURRENT DRAW (AMPS)**		CABLE LENGTH
BEC POSITIVE SWITCH MOTOR	*BEC NEGATIVE SWITCH MOTOR	BE SWITCH MOTOR		344B, 440B, 450B, 460B	BEC POSITIVE SWITCH MOTOR	*BEC NEGATIVE SWITCH MOTOR	BE SWITCH MOTOR	346B	
50515-22P	50515-22N	50533-22	1.1	50515-25P	50515-25N	50533-25	1.75	2.2	No Cable, Metri-Pack Connector
50515-22CP05	50515-22CN05*	50533-22C05	1.1	50515-25CP05	50515-25CN05*	50533-25C05	1.75	2.2	0.5 m Cable
50515-22CP15	50515-22CN15*	50533-22C15*	1.1	50515-25CP15	50515-25CN15*	50533-25C15*	1.75	2.2	1.5 m Cable
50515-22CP60	50515-22CN60*	50533-22C60*	1.1	50515-25CP60	50515-25CN60*	50533-25C60*	1.75	2.2	6 m Cable
50515-22DP	50515-22DN*	50533-22D*	1.1	50515-25DP	50515-25DN*	50533-25D*	1.75	2.2	DIN Electrical Connector
50515-22QP	50515-22QN*	50533-22Q*	1.1	50515-25QP	50515-25QN*	50533-25Q*	1.75	2.2	Deutsch Electrical Connector

Items marked with "\*" are non-stock items. \*\* Current draw is a nominal rating @ 13.8 VDC and will vary dependent upon valve usage and chemicals used.

**Note:** DIN cables are ordered separately.

## \*BYPASS VALVE (NORMALLY OPEN) BEC MOTORS

344B, 440B, 450B, 460B SERIES			CURRENT DRAW (AMPS)**	346B, 356 AND 490 SERIES			CURRENT DRAW (AMPS)**		CABLE LENGTH
BEC POSITIVE SWITCH MOTOR	*BEC NEGATIVE SWITCH MOTOR	BE SWITCH MOTOR		344B, 440B, 450B, 460B	BEC POSITIVE SWITCH MOTOR	*BEC NEGATIVE SWITCH MOTOR	BE SWITCH MOTOR	346B	
50994-22P	50994-22N	50533-22	1.1	50994-25P	50994-25N	50533-25	1.75	2.2	No Cable, Metri-Pack Connector
50994-22CP05	50994-22CN05*	50533-22C05	1.1	50994-25CP05	50994-25CN05*	50533-25C05	1.75	2.2	0.5 m Cable
50994-22CP15	50994-22CN15*	50533-22C15*	1.1	50994-25CP15	50994-25CN15*	50533-25C15*	1.75	2.2	1.5 m Cable
50994-22CP60	50994-22CN60*	50533-22C60*	1.1	50994-25CP60	50994-25CN60*	50533-25C60*	1.75	2.2	6 m Cable
50994-22DP	50994-22DN*	50533-22D*	1.1	50994-25DP	50994-25DN*	50533-25D*	1.75	2.2	DIN Electrical Connector
50994-22QP	50994-22QN*	50533-22Q*	1.1	50994-25QP	50994-25QN*	50533-25Q*	1.75	2.2	Deutsch Electrical Connector

Items marked with "\*" are non-stock items. \*\* Current draw is a nominal rating @ 13.8 VDC and will vary dependent upon valve usage and chemicals used.

**Note:** DIN cables are ordered separately.

## 344B & 346B REGULATING MOTORS

SPEED (RPM)	R & RL MOTOR NO.	PR MOTOR NO.	CURRENT DRAW (AMPS)**		CABLE LENGTH
			AA344B	AA346B	
1	50516-01*	50996-01*	0.10	0.12	No Cable, Metri-Pack Connector
1	50516-01C05*	50996-01C05*	0.10	0.12	0.5 m Cable
1	50516-01C15*	50996-01C15*	0.10	0.12	1.5 m Cable
1	50516-01C60*	50996-01C60*	0.10	0.12	6 m Cable
1	50516-01D*	50996-01D*	0.10	0.12	DIN Electrical Connector
1	50516-01Q*	50996-01Q*	0.10	0.12	Deutsch Electrical Connector
3	50516-03*	50996-03*	0.15	0.20	No Cable, Metri-Pack Connector
3	50516-03C05*	50996-03C05*	0.15	0.20	0.5 m Cable
3	50516-03C15*	50996-03C15*	0.15	0.20	1.5 m Cable
3	50516-03C60*	50996-03C60*	0.15	0.20	6 m Cable
3	50516-03D*	50996-03D*	0.15	0.20	DIN Electrical Connector
3	50516-03Q*	50996-03Q*	0.15	0.20	Deutsch Electrical Connector
6	50516-06*	50996-06*	0.43	0.50	No Cable, Metri-Pack Connector
6	50516-06C05*	50996-06C05*	0.43	0.50	0.5 m Cable
6	50516-06C15*	50996-06C15*	0.43	0.50	1.5 m Cable
6	50516-06C60*	50996-06C60*	0.43	0.50	6 m Cable
6	50516-06D*	50996-06D*	0.43	0.50	DIN Electrical Connector
6	50516-06Q*	50996-06Q*	0.43	0.50	Deutsch Electrical Connector

Items marked with "\*" are non-stock items. \*\* Current draw is a nominal rating @ 13.8 VDC and will vary dependent upon valve usage and chemicals used.

**Note:** DIN cables are ordered separately. See page 144 for DIN cable options.

## DIRECTOVALVE ELECTRIC PRESSURE REGULATING VALVES

The proper regulating valve will enhance the operation of a sprayer, especially one with an automatic rate controller. While advanced electronics provide features and control, the proper regulating valve helps the system to respond quickly to input changes and functions over a wide range of application rates. Choosing the proper valve involves determining the maximum capacity required, the range of application rates and the proper motor speed.

### SYSTEM CAPACITY

A regulating valve's system requirements will depend on the application amount and the pumping capacity. Additionally, the regulating valve can be used in bypass or throttling mode. In throttling mode, the flow through the valve will be applied through the nozzles. In bypass mode, the excess flow from the pump is recirculated. A valve that works well throughout the flow spectrum has the best chance to work in all situations.

### TYPES OF REGULATING VALVES

Special ball shapes make regulating valves more responsive and able to work with both high and low application rates. Most agricultural sprayers use either a 2-way ball valve or butterfly valve for regulating purposes. When considering sizing a regulating valve, the first concern is to understand the valve's flow curve to determine how efficiently the valve will regulate. Figure 1 shows typical flow curves for DirectoValve® regulating type valves. This will help to decide the type of valve to use.

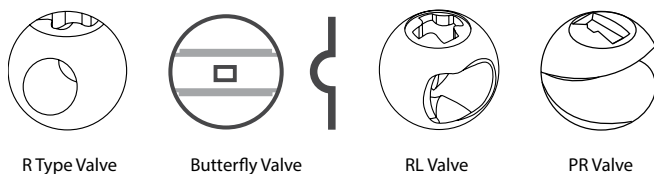

### REGULATING VALVE FLOW CURVES

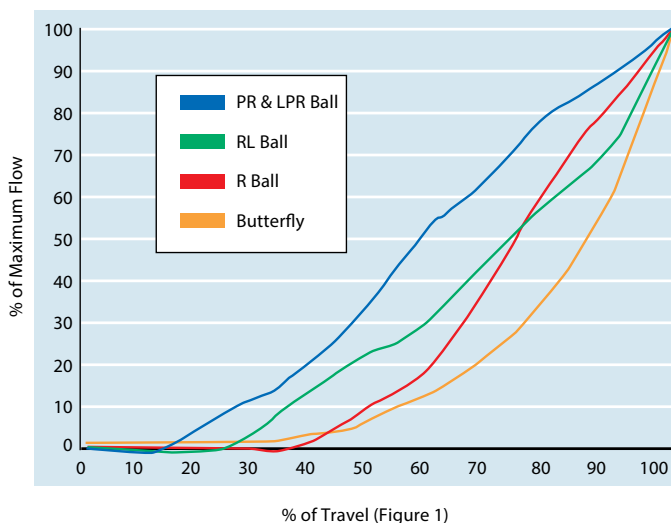

### R TYPE & BUTTERFLY VALVES

As shown on the graph, the butterfly valve has the most non-linear flow curve for final 1/3 (30°) of travel leading to an increase of 75% in flow through the valve. The straight 2-way "R" ball curve is not quite as steep, with the flow through the valve increasing by 60% over the last 30° of travel. The "R" ball, however, has the additional disadvantage of not allowing significant flow during the first 1/3 of its rotation. Since a small change of rotation causes a significant change using these valves, trying to regulate large flows when the valve is two thirds to full open presents a challenge.

### RL VALVE

TeeJet Technologies has developed a special ball that allows the valve to start regulating earlier thus extending the regulating range. This special ball valve also increases flow and the linear characteristic of the valve during the first 3/4 of the valve cycle. The flow from the valve starts 10° earlier, than a regular R type ball and increases the flow of the RL ball during the first 70% of travel (Figure 1). The maximum capacity is about 10% less than an R type valve.

### PR VALVE

The PR valve uses a 3-way valve body and a ball with a wedge removed. The combination of this ball and a motor that rotates past the standard 90° results in a valve with an almost linear flow curve. The BPR version has one outlet plugged. The 3PR version allows bypass flow to return to the tank.

As noted in Figure 1, the percentage of flow increases by approximately the amount of ball travel thus avoiding the rapid change seen with standard ball valves and butterfly valves.

### LPR VALVE

The LPR valve is similar to the PR, but with a much smaller wedge removed for very precise regulation in low flow applications.

### BALL TYPE REGULATING VALVES

MODEL NUMBER	MAXIMUM PRESSURE	FLOW RATE AT A 0.34 bar PRESSURE DROP	FLOW RATE AT A 0.69 bar PRESSURE DROP
344BR-2	20 bar	121 l/min	170 /min
344BR-3	20 bar	91 l/min	129 l/min
344BRL-2	20 bar	102 l/min	144 l/min
344BPR-2*	20 bar	45 l/min	64 l/min
344BPR-3*	20 bar	45 l/min	64 l/min
344BLPR-2*	20 bar	5.7 l/min	8 l/min
344BLPR-3*	20 bar	5.7 l/min	8 l/min
346BR-2	10 bar	379 l/min	534 l/min
346BR-3	10 bar	242 l/min	344 l/min
346BPR-2*	10 bar	200 l/min	284 l/min
346BPR-3*	10 bar	200 l/min	284 l/min

\* Not available in stainless steel.



344 BPR Series



346 R Series



346 BPR Series

# (B)344BRL-2FS-01C15AB

OUTLET THREADS	
BLANK	All Threads to be NPT (If Equipped)
(B)	All Threads to be BSPT (If Equipped)

MODEL SPECIFICATIONS	
344B/ 346B	Regulating Valve
364B/ 366B	Regulating Valve with Mounting Foot

MOTOR SPECIFICATIONS	
R	Regulating Valve
RL	Linear Regulating Valve (344 Series Only)
PR*	Pressure Regulating Valve
LPR**	Low-Flow PR Valve

\*Not available in stainless steel.  
\*\*Available only in stainless steel.

VALVE TYPE	
2	2-Way Valve
3	3-Way Valve (LPR, PR & R Only)

END CAPS OR OUTLET FITTINGS	
3	¾" Pipe Thread (344B/364B Only)
4	1" Pipe Thread (344B/364B Only)
5	1¼" Pipe Thread (346B/366B Only)
6	1½" Pipe Thread (346B/366B Only)
Q	Quick Connect (344B/364B Only)
F	50 Series Flange
F75	75 Series Flange (346B/366B Only)
LQ	Large Quick Connect (364B/366B Only)

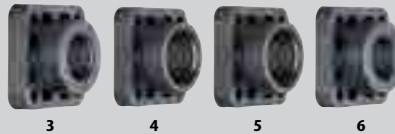

MOTOR SPEEDS	
01	1 RPM (18 Second Cycle Time) Motor
03	3 RPM (6 Second Cycle Time) Motor
06	6 RPM (3 Second Cycle Time) Motor

Note: PR/LPR series cycle times are doubled.

BALL MATERIAL SPECIFICATIONS	
BLANK	Polypropylene Ball
S	Stainless Steel Ball (R, LPR & RL Series Only)

MOTOR CABLES	
BLANK	Metri-Pack Connector
C	0.5-Meter Cable
C03*	0.3-Meter Cable
C15*	1.5-Meter Cable
C60*	6.0-Meter Cable
D	DIN Connector
Q	Positively Switched with Deutsch Connector

Items marked with "\*" are non-stock items. Contact your regional sales office for ordering and availability information.

Note: DIN cables must be ordered separately. See page 144 for DIN cables.

INLET/OUTLET REQUIRED CONNECTIONS (THE INLET/OUTLET FITTINGS ARE ORDERED SEPARATELY)	
• 3, 4, 5, 6:	When ordering ¾" (3), 1" (4), 1¼" (5) or 1½" (6) threaded NPT or BSPT inlet/outlet type valve connections, the inlets and outlets will be included during assembly.
• F:	When ordering F or F75 (flange) type valve connections, the inlet/outlet fittings are ordered separately. Clamps and flange fittings are required. See page 158 for flange fitting options.
• Q:	When ordering QC (Quick Connect) hose barb type valve fittings, the inlet/outlet connections are ordered separately. Two 45529 QC fittings are required for 2-way valves and three each for 3-way valves. See page 159 for QC options.
<b>Note:</b> Many valve configurations are possible by mixing and matching flange fittings.	

WIRING CONNECTORS	
Specify electrical connector style and pin-outs. If no connector is needed leave blank. See page 157 for electrical connectors and codes.	

REPAIR KITS	
AB344AE-KIT	AB346B-KIT

Note: AB344AE-KIT for 344A&B Valves

VALVES & MANIFOLDS

# DirectoValve® 300 SERIES



344BEC-24-P  
2-Way Valve



344BEC-34-P  
3-Way Valve



356BEC-D  
Valve

REGULATING VALVES	MOTOR SPEED (RPM)	INLET/OUTLET	FLOW RATE (l/min)*		MAX. PRESSURE (bar)
344B, 2-Way	1, 3, or 6	¾" or 1", 50 Series Flange, QC	121 (R Valve)	102 (RL)	20
			45 (PR)	3.8 (LPR)	
344B, 3-Way	1, 3, or 6	¾" or 1", 50 Series Flange, QC	121 (R Valve)	102 (RL)	20
			45 (PR)	3.8 (LPR)	
346B, 2-Way	1, 3, or 6	1½", or 1¼", 50 Series Flange, 75 Series Flange	379		10
346B, 3-Way	1, 3, or 6	1½", or 1¼", 50 Series Flange, 75 Series Flange	242		10
SHUT OFF VALVES	MOTOR SPEED (RPM)	INLET/OUTLET	FLOW RATE (l/min)*		MAX. PRESSURE (bar)
344B, 2-Way	22	¾" or 1", QC, 50 Series Flange	121		20
344B, 3-Way	22	¾" or 1", QC, 50 Series Flange	91		20
346B, 2-Way	25	1¼" or 1½", 50 Series Flange, 75 Series Flange	379		10
346B, 3-Way	25	1¼" or 1½", 50 Series Flange, 75 Series Flange	242		10
356B, 2-Way	25	50 Series Flange	379		10

**Note:** Flow rates are given for a single valve @ 0.34 bar pressure drop and will vary based on the number of valves and inlet sizes.



# (B)344BEC-2FS-C15AB

OUTLET THREADS	
BLANK	All Threads to be NPT (If Equipped)
(B)	All Threads to be BSPT (If Equipped)

MODEL SPECIFICATIONS	
344B/ 346B	Shutoff Valve
356B	Shutoff Valve with Mounting Foot

MOTOR SPECIFICATIONS		
E	DPDT	22 RPM, 0.7 SEC Cycle (for 344B/364B)
EC	SPST	25 RPM, 0.6 SEC Cycle (for 346B/366B)

VALVE TYPE	
2	2-Way Valve
3	3-Way Valve

END CAPS OR OUTLET FITTINGS	
3	¾" Pipe Thread (344B/364B Only)
4	1" Pipe Thread (344B/364B Only)
5	1¼" Pipe Thread (346B/366B Only)
6	1½" Pipe Thread (346B/366B Only)
Q	Quick Connect (344B/364B Only)
F	50 Series Flange
F75	75 Series Flange (346B/366B Only)
LQ	Large Quick Connect (364B/366B Only)

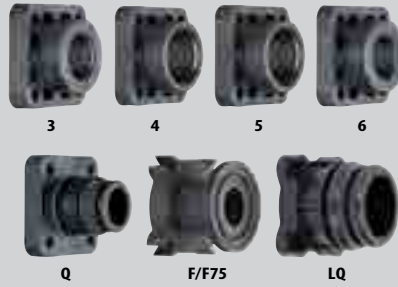

BALL MATERIAL SPECIFICATIONS	
BLANK	Polypropylene Ball
S	Stainless Steel Ball

MOTOR CABLES	
C	Positively Switched with 0.5-m Cable
C03*	Positively Switched with 0.3-m Cable
C15*	Positively Switched with 1.5-m Cable
C60*	Positively Switched with 6.0-m Cable
D	Positively Switched with DIN Connector
P	Positively Switched with Metri-Pack Connector
Q	Positively Switched with Deutsch Connector

Items marked with "\*" are non-stock items. Contact your regional sales office for ordering and availability information. CN (Negatively Switched) motors also available upon request. **Note:** DIN cables must be ordered separately. See page 144 for DIN cables.

INLET/OUTLET REQUIRED CONNECTIONS (THE INLET/OUTLET FITTINGS ARE ORDERED SEPARATELY)	
•	<b>3, 4:</b> When ordering ¾" (3) or 1" (4) threaded NPT or BSPT inlet/outlet type valve connections, the inlets and outlets will be completed during the ordering process.
•	<b>F:</b> When ordering F (flange) type valve connections, the inlet/outlet fittings are ordered separately. Two 50 series clamps and flange fittings are required for 2-way valves and three each for 3-way valves. See page 158 for flange fitting options.
•	<b>Q:</b> When ordering QC (Quick Connect) hose barb type valve fittings, the inlet/outlet connections are ordered separately. Two 45529 QC fittings are required for 2-way valves and three each for 3-way valves. See page 159 for QC options.
<b>Note:</b> Many valve configurations are possible by mixing and matching flange fittings.	

WIRING CONNECTORS	
Specify electrical connector style and pin-outs. If no connector is needed leave blank. See page 157 for electrical connectors and codes.	

REPAIR KITS	
AB344AE-KIT for 344A&B Valves AB346B-KIT for 346B Valves	

VALVES & MANIFOLDS



# DirectoValve® 430 SERIES



430 Flow Back  
Single Valve



430 2-Way  
Single Valve



430 3-Way  
Single Valve

SHUT OFF VALVES	INLET	OUTLET	FLOW RATE (l/min)*	MAX. PRESSURE (bar)
430, Flowback	75 Series Flange, QC	QC	35	15
430, 2-Way	QC, 75 Series Flange	QC	44	15
430, 3-Way	QC, 75 Series Flange	QC	44	15

**Note:** Flow rates are given for a single valve @ 0.34 bar pressure drop and will vary based on the number of valves and inlet sizes.



VALVES & MANIFOLDS



# 437EC-3FBF75-D

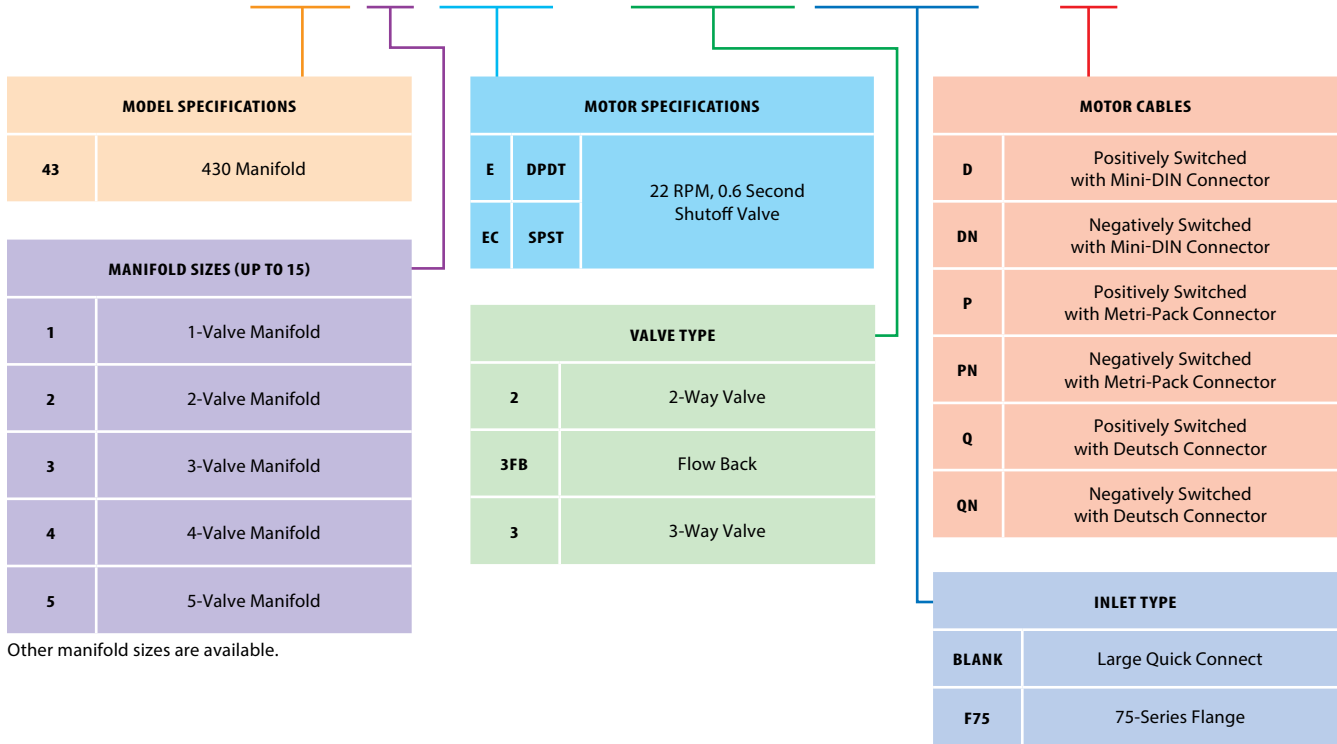

## SAMPLE MINI-DIN CABLE ASSEMBLY PART CODE

# 58480EC-15-VX

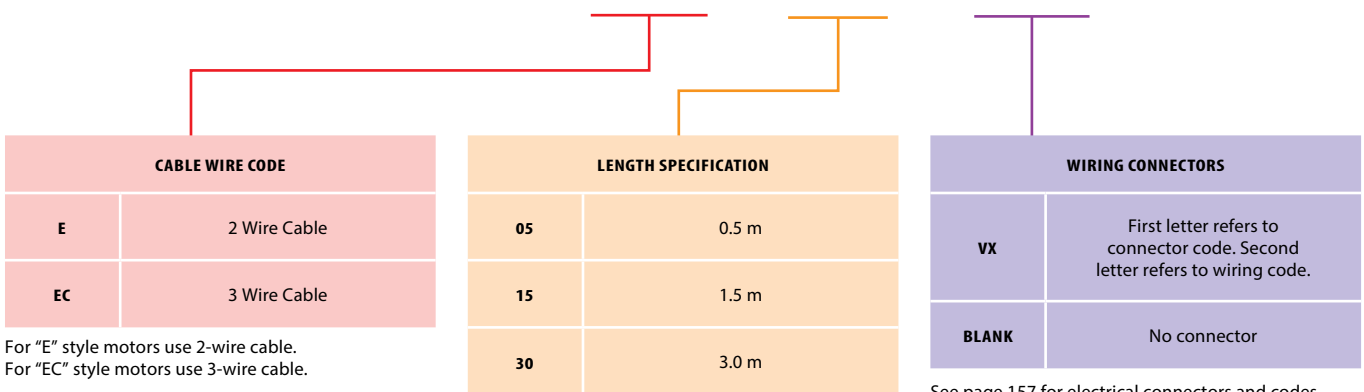

# DirectoValve® 400 SERIES



451BEC-2F-P  
Valve



453BEC-3FBF-P  
Manifold



453BEC-2F-P  
Manifold

SHUT OFF VALVES	INLET	OUTLET	FLOW RATE (l/min)*	MAX. PRESSURE (bar)
<b>440B, 2-Way</b>	¼" or 1" NPT, 1" or 1¼" Hose Barb	¾" or 1", 50 Series Flange, QC	98	20
<b>450B, 2-Way</b>	75 Series Flange	¾" or 1", 50 Series Flange, QC	120	14
<b>450B, Flowback</b>	75 Series Flange	¾" or 1", 50 Series Flange, QC	120	14
<b>460B, 2-Way</b>	50 Series Flange	¾" or 1", 50 Series Flange, QC	94	20
<b>460B, 3-Way</b>	50 Series Flange	¾" or 1", 50 Series Flange, QC	94	20
<b>460B, Flowback</b>	50 Series Flange	¾" or 1", 50 Series Flange, QC	91	8
<b>490B</b>	75 Series Flange	50 Series Flange	379	10

**Note:** Flow rates are given for a single valve @ 0.34 bar pressure drop and will vary based on the number of valves and inlet sizes.



# (B)453BEC-3FBFS-C15AB

OUTLET THREADS	
BLANK	All Threads to be NPT (If Equipped)
(B)	All Threads to be BSPT (If Equipped)

MODEL SPECIFICATIONS	
45	450 Manifold

MANIFOLD SIZES	
1	1-Valve Manifold
2	2-Valve Manifold
3	3-Valve Manifold
4	4-Valve Manifold
5	5-Valve Manifold

VALVE TYPE	
3FB	Flow Back
2	2-Way Valve
2N	2-Way Valve, Narrow

END CAPS OR OUTLET FITTINGS	
3	¾" Pipe Thread
4	1" Pipe Thread
Q	Quick Connect
F	50 Series Flange

MOTOR SPECIFICATIONS	
E	DPDT
EC	SPST
22 RPM, 0.7 Second Shutoff Valve	

BALL MATERIAL SPECIFICATIONS	
BLANK	Polypropylene Ball
S	Stainless Steel Ball

MOTOR CABLES	
C	Positively Switched with 0.5-m Cable
C03*	Positively Switched with 0.3-m Cable
C15*	Positively Switched with 1.5-m Cable
C60*	Positively Switched with 6.0-m Cable
D	Positively Switched with DIN Connector
P	Positively Switched with Metri-Pack Connector

WIRING CONNECTORS	
Specify electrical connector style and pin-outs. If no connector is needed leave blank. See page 157 for electrical connectors and codes.	

REPAIR KITS	
AB344AE-KIT	

INLET/OUTLET REQUIRED CONNECTIONS (THE INLET/OUTLET FITTINGS ARE ORDERED SEPARATELY)	
<ul style="list-style-type: none"> <li><b>3, 4:</b> When ordering ¾" (3) or 1" (4) NPT or BSPT threaded connections, the valve outlet connection will be completed during the ordering process. <ul style="list-style-type: none"> <li>For the inlets, two 75 Series flange fittings and two 75 Series clamps are required. For the Flow Back ports, two 45529 Quick Connect fittings are required.*</li> </ul> </li> <li><b>F:</b> For the flange fitting versions, one 50 Series single clamp and 50 Series flange fitting is required per valve outlet. <ul style="list-style-type: none"> <li>For the inlets, two 75 Series flange fittings and two 75 Series clamps are required. For the Flow Back ports, two 45529 Quick Connect fittings are required.*</li> </ul> </li> <li><b>Q:</b> For Quick Connect versions, one 45529 QC hose barb fitting is required per valve outlet. <ul style="list-style-type: none"> <li>For the inlets, two 75 series flange fittings and two 75 Series clamps are required. For the Flow Back ports, two 45529 Quick Connect fittings are required.*</li> </ul> </li> </ul> <p>*See pages 158–159 for flange and Quick Connect fitting options.</p> <p><b>Note:</b> Many manifold configurations are possible by mixing and matching flange fittings.</p>	

Items marked with "\*" are non-stock items. Contact your regional sales office for ordering and availability information. CN (Negatively Switched) motors also available upon request. **Note:** DIN cables must be ordered separately. See page 144 for DIN cables.

# DirectoValve® 500 SERIES



MANUAL SHUT OFF VALVES	INLET	OUTLET	FLOW RATE (l/min)*	MAX. PRESSURE (bar)
530AM, 2-Way	LQC, QC, 50 Series Flange, 75 Series Flange	QC	37.9	20
530AM, 3-Way	LQC, QC, 50 Series Flange, 75 Series Flange	QC	37.9	20
ELECTRIC SHUT OFF VALVES	INLET	OUTLET	FLOW RATE (l/min)*	MAX. PRESSURE (bar)
530AEC, 2-Way	LQC, QC, 50 Series Flange, 75 Series Flange	QC	37.9	20
530AEC, 3-Way	LQC, QC, 50 Series Flange, 75 Series Flange	QC	37.9	20
530AEC, Flow Back	LQC, QC, 50 Series Flange, 75 Series Flange	QC	37.9	20
540EC	75 Series Flange	QC	102	12

**Note:** Flow rates are given for a single valve @ 0.34 bar pressure drop and will vary based on the number of valves and inlet sizes.



# 533AEC-2F50-PN

MANIFOLD SIZES (UP TO 15)	
1	1-Valve Manifold
2	2-Valve Manifold
3	3-Valve Manifold
4	4-Valve Manifold
5	5-Valve Manifold

MOTOR SPECIFICATIONS		
AE	DPDT	Electric Shut-Off Valve
AEC	SPST	Electric Shut-Off Valve
AM	MANUAL	Manual Shut-Off Valve

VALVE TYPE	
2	2-Way Valve
3	3-Way Valve
FB	Flow Back (Electric Only)

INLET FITTINGS	
BLANK	Large Quick Connect
F50	50 Series Flange
F75	75 Series Flange
Q	Quick Connect

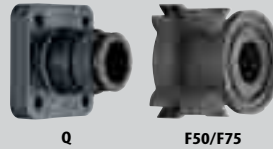

MOTOR CABLES	
D	Positively Switched with Mini-DIN Connector
DN	Negatively Switched with Mini-DIN Connector
P	Positively Switched, with Metri-Pack Connector, No Cable
PN	Negatively Switched, with Metri-Pack Connector, No Cable
Q	Positively Switched with Deutsch Connector
QN	Negatively Switched with Deutsch Connector

REPAIR KITS	
AB530AM-2-KIT	
AB530A-2-KIT	
AB530A-3-KIT	
AB530A-FB-KIT	

**INLET/OUTLET REQUIRED CONNECTIONS (THE INLET/OUTLET FITTINGS ARE ORDERED SEPARATELY)**

- F:** For inlets, two 75 Series clamps and flange fittings or two 50 Series clamps and flange fittings are required. See page 158 for flange fitting options.
- LQ:** For large quick connect inlets, two 58456 fittings are required. See page 159 for LQ fitting options.
- Q:** For Quick Connect inlet and outlet, one 45529 QC hose barb is required per connection. See page 159 for Quick Connect fitting options.

## SAMPLE METRI-PACK CABLE ASSEMBLY PART CODE

# 98546EC-15-VX

CABLE WIRE CODE	
E	2 Wire Cable
EC	3 Wire Cable

LENGTH SPECIFICATION	
05	0.5 m
15	1.5 m
30	3.0 m

WIRING CONNECTORS	
Specify electrical connector style and pin-outs. If no connector is needed leave blank.	
See Page 157 for electrical connectors and codes.	

For "E" style motors use 2-wire cable.  
For "EC" style motors use 3-wire cable.



## CONTROL UNITS

- Pressure relief valve (98510-PP).
- 344BRL electric regulating valve, bypass mode for 98600-C-433E(C) and 98601-B-433E(C) models.
- Liquid strainer (AA126ML-M50-80-VI) for 98600-C-433E(C) and 98601-B-433E(C) models.
- Flowmeter (801A) for 98600-C-433E(C) models.



MODEL NUMBER	VALVE SECTIONS	VALVE TYPE	PRESSURE (bar)	FLOW PER SECTION
98600-C-433E(C)-2	3	2-Way	15	44 l/min (0.34 bar Pressure Drop)
98601-C-435E(C)-3FB	5	Flow Back	15	35 l/min (0.34 bar Pressure Drop)
98602-C-434E(C)-3	4	3-Way	15	44 l/min (0.34 bar Pressure Drop)
98600-B-433E(C)-2	3	2-Way	15	44 l/min (0.34 bar Pressure Drop)
98601-B-434E(C)-3FB	4	Flow Back	15	35 l/min (0.34 bar Pressure Drop)
98602-B-435E(C)-3	5	3-Way	15	44 l/min (0.34 bar Pressure Drop)
98600-A-437E(C)-2	7	2-Way	15	44 l/min (0.34 bar Pressure Drop)
98601-A-435E(C)-3FB	5	Flow Back	15	35 l/min (0.34 bar Pressure Drop)
98602-A-433E(C)-3	3	3-Way	15	44 l/min (0.34 bar Pressure Drop)

**Note:** Valves can be ordered in 1–9 sections configuration. For inlet and outlet connections refer to page 159.





## 430/530 MANIFOLD ACCESSORIES

MODEL NUMBER	DESCRIPTION
344BRL-B	Bypass Regulating Valve
344BRL-TH	Throttling Regulating Valve
346BEC-2M	2-Way 3-Valve Shutoff Manifold
98510-NYB	Pressure Relief Valve
118560	Compact Pressure Relief Valve
118570	Compact Throttling Valve
AA126ML-M50	Line Strainer
AA122ML-QC	Outlet Strainer
801A	Flowmeter
AB98499-KIT	4-Bolt Flange Accessory Mounting Kit
CP98498-SS	Mounting Bracket

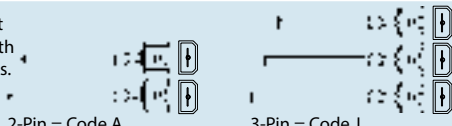
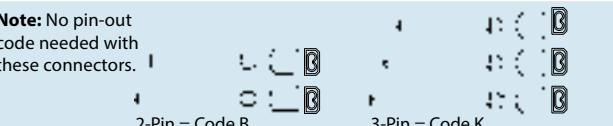
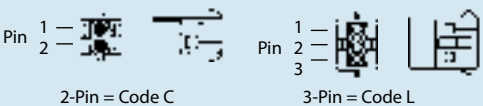
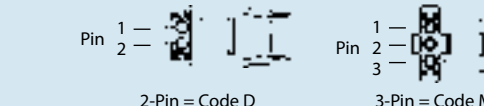
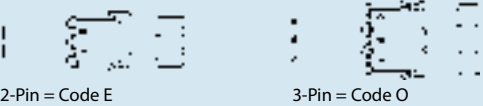
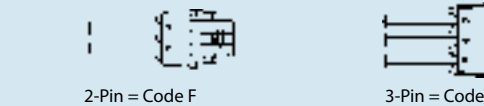
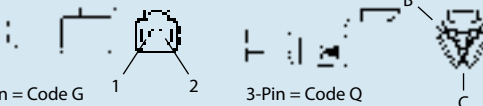

**Note:** TeeJet Technologies recommends the use of sealed connectors to improve reliability and prolong component life.

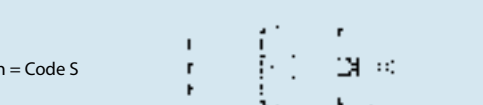
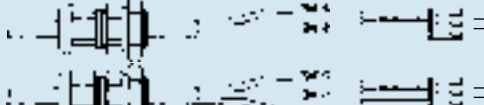
**CHART 1: CONNECTOR CODES**

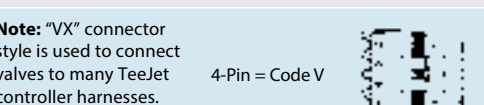
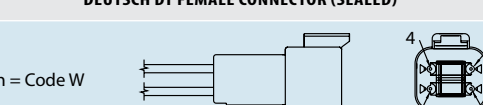
2-PIN OR 3-PIN	<p><b>AMP MALE FASTON CONNECTOR</b></p> <p><b>Note:</b> No pin-out code needed with these connectors.</p>  <p>2-Pin = Code A      3-Pin = Code J</p>	<p><b>AMP FEMALE FASTON CONNECTOR</b></p> <p><b>Note:</b> No pin-out code needed with these connectors.</p>  <p>2-Pin = Code B      3-Pin = Code K</p>
	<p><b>AMP FEMALE MATE-N-LOK® CONNECTOR (SEALED)</b></p>  <p>2-Pin = Code C      3-Pin = Code L</p>	<p><b>AMP MALE MATE-N-LOK® CONNECTOR (SEALED)</b></p>  <p>2-Pin = Code D      3-Pin = Code M</p>
	<p><b>WEATHER PACK SHROUD CONNECTOR (SEALED)</b></p>  <p>2-Pin = Code E      3-Pin = Code O</p>	<p><b>WEATHER PACK TOWER CONNECTOR (SEALED)</b></p>  <p>2-Pin = Code F      3-Pin = Code P</p>
	<p><b>DEUTSCH DT FEMALE CONNECTOR (SEALED)</b></p>  <p>2-Pin = Code G      3-Pin = Code Q</p>	<p><b>DEUTSCH DT MALE CONNECTOR (SEALED)</b></p>  <p>2-Pin = Code H      3-Pin = Code R</p>
	<p><b>METRIPACK FEMALE CONNECTOR (SEALED)</b></p>  <p>3-Pin = Code S</p>	<p><b>JST VH FEMALE CONNECTOR (SEALED)</b></p>  <p>2-Pin = Code I      3-Pin = Code T</p>
	<p><b>WEATHER PACK SHROUD CONNECTOR (SEALED)</b></p>  <p>4-Pin = Code U</p>	<p><b>WEATHER PACK TOWER CONNECTOR (SEALED)</b></p> <p><b>Note:</b> "VX" connector style is used to connect valves to many TeeJet controller harnesses.</p>  <p>4-Pin = Code V</p>
	<p><b>DEUTSCH DT FEMALE CONNECTOR (SEALED)</b></p>  <p>4-Pin = Code W</p>	

**CHART 2: PIN-OUT CODES**

CODE LETTER	CONNECTOR POSITION				CODE LETTER	CONNECTOR POSITION			
	A OR 1	B OR 2	C OR 3	D OR 4		A OR 1	B OR 2	C OR 3	D OR 4
A	R	W	P	B	M	P	R	W	B
B	R	W	B	P	N	P	R	B	W
C	R	B	W	P	O	P	W	R	B
D	R	B	P	W	P	P	W	B	R
E	R	P	W	B	Q	P	B	R	W
F	R	P	B	W	R	P	B	W	R
G	W	R	B	P	S	B	R	W	P
H	W	R	P	B	T	B	R	P	W
I	W	P	R	B	U	B	W	R	P
J	W	P	B	R	V	B	W	P	R
K	W	B	R	P	W	B	P	R	W
L	W	B	P	R	X	B	P	W	R

For regulating and E-style, 2-wire cables, the white position will be plugged.

## HOW TO ORDER

This system is to be used for ball valves and ball valve manifolds equipped with electrical connectors. Connector and pin-outs are to be specified in valve or manifold part number when ordering. **Note:** On 2-pin connectors, only pin-out code C or S is used.

**First:** Specify code for connector desired (See Chart 1).

**Second:** Specify appropriate wire pin-out arrangement (See Chart 2).

3 5 6 B E C - C L B



### Wire Codes

R = Red (+12V)    W = White (Switched)  
P = Plugged      B = Black (Ground)



## 50 SERIES FLANGED FITTINGS

- Maximum pressure rating of 20 bar.
- Polypropylene construction.

PART NUMBER	DESCRIPTION
CP48150-PP	3/4" Hose Barb
CP45504-PP	1" Hose Barb
CP45505-PP	1 1/4" Hose Barb
CP45506-PP	1 1/2" Hose Barb
CP48151-PP	90° x 3/4" Hose Barb
CP48152-PP	90° x 1" Hose Barb
CP72238-PP	90° x 1 1/4" Hose Barb
CP72239-PP	90° x 1 1/2" Hose Barb
CP(B)48172-PP	3/4" Male Pipe Thread
CP(B)48155-PP	1" Male Pipe Thread
CP(B)48156-PP	1 1/2" Male Pipe Thread
CP(B)48159-PP	3/4" Female Pipe Thread
CP(B)48154-PP	1" Female Pipe Thread
CP(B)45512-PP	1 1/4" Female Pipe Thread
CP(B, P)45508-1/4-PP	1/4" Gauge Port
CP(B, P)45539-3/8-PP	3/8" Gauge Port
CP45507-PP	Blank Inlet Cover
CP48157-PP	Straight Coupling
CP48158-PP	90° Elbow Coupling
CP46029-PP	Male Quick Connect Adapter
CP50193-PP*	Tee
CP55242-PP*	Narrow Tee
46070**	2-Way 460 Valve Clamp, Nylon
46024**	3-Way 460 Valve Clamp, Nylon
55245-50**	50 Series Flange Clamp, Stainless Steel
CP7717-2/222-VI	50 Series Clamps O-Ring, FKM
CP98491-PP	Bolted Flange Adapter

\*There are no mounting provisions on the 50 Series tee. (B)=BSPT (P)=BSPP  
 \*\*O-ring included.

## 75 SERIES FLANGED FITTINGS

- Maximum pressure rating of 14 bar.
- Polypropylene construction.

PART NUMBER	DESCRIPTION
CP48160-PP	1 1/4" Hose Barb
CP46067-PP	1 1/2" Hose Barb
CP48161-PP	2" Hose Barb
CP48162-PP	90° x 1 1/4" Hose Barb
CP48163-PP	90° x 1 1/2" Hose Barb
CP48164-PP	90° x 2" Hose Barb
CP(B)48165-PP	1 1/4" Male Pipe Thread
CP(B)48166-PP	1 1/2" Male Pipe Thread
CP(B)48167-PP	2" Male Pipe Thread
CP(B)46066-PP	1 1/2" Female Pipe Thread
CP(B)46127-1/4-PP	1/4" Gauge Port
CP(B)46127-3/8-PP	3/8" Gauge Port
CP46069-PP	Blank Inlet Cover
CP48169-PP	Straight Coupling
CP45207-PP	75 x 50 Series Reducer Coupling
CP48168-PP	90° Elbow Coupling
CP46717-PP	75 x 50 Series Reducer Tee
CP46716-PP	Tee
CP45251-PP	450 Tee Body
CP55224-PP	450 Tee Body (Narrow)
55245-75**	75 Series Flange Clamp, Stainless Steel
CP7717-2-229-VI	75 Series Clamps O-Ring, FKM
CP98490-PP	F75 Bolted Flange Adapter

\*\*O-ring included. (B)=BSPT (P)=BSPP

## 48143 MOUNTING KIT

Mounts to underside of tee and includes one extrusion and four screws. Mounting kit is not included with tees. Must be ordered separately. Also requires 5/16" or 8 mm bolt.

PART NUMBER	DESCRIPTION
48143	Tee Mounting Kit (450 or 490 Series Manifold)



45529-1/2



45529-C



45529-PTC-4-3/8



45529-90-1



CP46029-PP



CP45527-NYB



CP45527-NYB



45529-P



58456-1-1/4



58456-1000



58456-90-1000



58456-C



116240-LM



58456-P



58456-1250M

## QUICK CONNECT FITTINGS

- Use on valves and components equipped with Quick Connect outlets.
- Rated to 20 bar.

PART NUMBER	DESCRIPTION
45529-C	Quick Connect Cap (F)
45529-P	Quick Connect Plug (M)
45529-3/8*	3/8" Straight Hose Barb (F)
45529-1/2*	1/2" Straight Hose Barb (F)
45529-5/8*	5/8" Straight Hose Barb (F)
45529-3/4*	3/4" Straight Hose Barb (F)
45529-1*	1" Straight Hose Barb (F)
45529-90-1/2*	1/2" 90° Hose Barb (F)
45529-90-5/8*	5/8" 90° Hose Barb
45529-90-3/4*	3/4" 90° Hose Barb (F)
45529-90-1*	1" 90° Hose Barb (F)
45529-90-1-1/4*	1 1/4" 90° Hose Barb
45529-3/4M	3/4" Hose Barb (M)*
45529-1M	1" Hose Barb (M)*
CP46029-PP	50 Series Flange (M)
CP45527-NYB	3/4" Male Pipe Thread
CP45526-NYB	1" Male Pipe Thread
45529-QT	Quick TeeJet Straight Fitting
45529-PTC-4-3/8	4 x 3/8" PTC Quick Connect Fitting
CP37166-1-302SS	Retaining Clip 302SS
CP7717-3-912-VI	O-Ring (FKM)
CP116237-NYB	QC Bolted Flange Adapter

\*Includes Retaining Clip and O-Ring.

## LARGE QUICK CONNECT FITTINGS

- Used for 430 and 530 manifold inlets and select ball valves.
- Rated to 15 bar.

PART NUMBER	DESCRIPTION
58456-C	Cap Fitting
58456-P	Plug Fitting
(B)58456-1/4	1/4" Female Thread (Gauge Port)
(B)58456-3/4	3/4" Female Thread (Gauge Port)
(B)58456-1	1" Female Thread (Gauge Port)
(B)58456-1-1/4	1 1/4" Female Thread (Gauge Port)
(B)58456-1-1/2	1 1/2" Female Thread (Gauge Port)
58456-1000	1" Straight Hose Barb
58456-1250	1 1/4" Straight Hose Barb
58456-1500	1 1/2" Straight Hose Barb
58456-2000	2" Straight Hose Barb
58456-90-1000	1" 90° Hose Barb
58456-90-1250	1 1/4" 90° Hose Barb
58456-90-1500	1 1/2" 90° Hose Barb
58456-90-2000	2" 90° Hose Barb
58456-1250M	1 1/4" Hose Barb
58456-1500M	1 1/2" Hose Barb
116240-LM*	Tee
CP37166-1-302SS	Retaining Clip 302SS
CP7717-M40X4-VI	O-Ring (FKM)
CP98497-PP	LQC Bolted Flange Adapter

Note: Retaining Clip and O-Ring included.

(B)=BSPT

\*Includes 3 O-Rings and 3 Retaining Clips.

### AA144P-, AA144A- & AA145H- DIRECTOVALVE CONTROL VALVES

- Direct acting; large internal flow chamber without pilot hole reduces chance of clogging.
- Stainless steel wetted parts provide additional corrosion resistance.
- Operate on 12 VDC system.
- Maximum pressure of 7 bar.
- Encapsulated solenoid coil can be changed without removing valve from system.
- EPDM diaphragms and seat washers, FKM optional.
- Continuous flow through bypass connection, with flow to spray line controlled by valve "on-off" action.

### AA144P DIRECTOVALVE CONTROL VALVES

- Flow Rate: 38 l/min at 0.34 bar pressure drop, 53 l/min at 0.69 bar pressure drop.
- 2.5 AMP current draw.
- Polypropylene body for chemical resistance.
- Fabric reinforced FKM diaphragms and seat washers.
- No stroke adjustment required.
- Corrosion resistant, 430SS solenoid grade armature and armature stop.
- Encapsulated coil and magnetic circuit.

MODEL NUMBER	INLET SIZE	OUTLET SIZE	CURRENT DRAW
AA(B)144P-*	3/4"	1/2"	2.5 AMP

(B) = BSPT



### AA144A VALVE FOR PRESSURES UP TO 7 BAR

- Flow Rate: 38 l/min at 0.34 bar pressure drop, 53 l/min at 0.69 bar pressure drop.
- Can be ganged with other 144A DirectoValve control valves.
- 2.5 AMP current draw.
- Polypropylene body for chemical resistance.
- Fabric reinforced diaphragms.
- Also available as 2- or 3-unit assembly.

MODEL NUMBER	INLET SIZE	OUTLET SIZE	CURRENT DRAW
AA(B)144A-*	3/4"	1/2"	2.5 AMP

(B) = BSPT

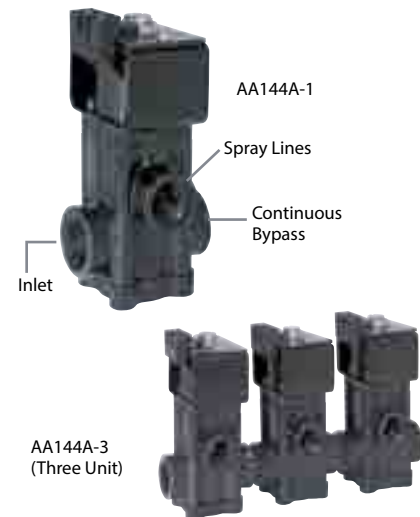

### AA145H CONTROL VALVES

- Flow Rate: 57 l/min at 0.34 bar pressure drop, 79 l/min at 0.69 bar pressure drop.
- Can be ganged with other 145H DirectoValve control valves.
- 2.9 AMP current draw.
- Fiberglass reinforced Nylon body.

MODEL NUMBER	INLET SIZE	OUTLET SIZE	CURRENT DRAW
AA145H-1	1"	1"	2.9 AMP





AA144P-1-3

### AA144P-1-3 DIRECTOVALVE CONTROL VALVES

The 144P-1-3 three-way solenoid-operated DirectoValve control valve was specifically designed to provide bypass control in spraying applications. When used with part number 23520-PP throttling valve or a 4916 metering orifice plate in the bypass line, it can provide for a constant pressure spray system.

- For pressure to 4.5 bar.
- Flow Rate: 30 l/min at 0.34 bar pressure drop, 42 l/min at 0.69 bar pressure drop.
- Fabric-reinforced FKM diaphragms.
- Nylon encapsulated 12 VDC coil with ¼" Quick Connect terminals.
- Power requirement 2.5 AMP.
- Glass-filled polypropylene (black) valve body.
- Internal metal parts are stainless steel.
- No stroke adjustment needed.
- Corrosion resistant, 430SS solenoid grade armature and armature stop.



AA144P-3-3  
(Three Unit)

### AA144A-1-3 DIRECTOVALVE CONTROL VALVES

The three-way solenoid-operated DirectoValve control valve bypasses boom flow to maintain constant spraying pressure when one or more boom sections are shut off. To maintain pressure with a 23520 Throttling Valve, Outlet 2 must be throttled to match the total capacity of the nozzles on that boom section.

- For pressures to 4.5 bar.
- Flow Rate: 30 l/min at 0.34 bar pressure drop, 42 l/min at 0.69 bar pressure drop.
- 2.5 AMP current draw.
- Encapsulated 12 VDC coil can be easily changed without removing valve from line.
- Polypropylene body for chemical resistance.
- Stainless steel internal metal parts.
- Chemical resistant EPDM diaphragms and seat washers.



AA144A-3-3  
(Three Unit)

MODEL NUMBER	NUMBER OF UNITS IN ASSEMBLY	SPRAY LINE CONNECTION	CONTINUOUS FLOW INLET BYPASS CONNECTION
AA(B)144P-1-3	1	½"	¾"
AA(B)144P-2-3	2	½"	¾"
AA(B)144P-3-3	3	½"	¾"
AA(B)144A-1-3	1	½"	¾"
AA(B)144A-2-3	2	½"	¾"
AA(B)144A-3-3	3	½"	¾"

(B) = BSPT

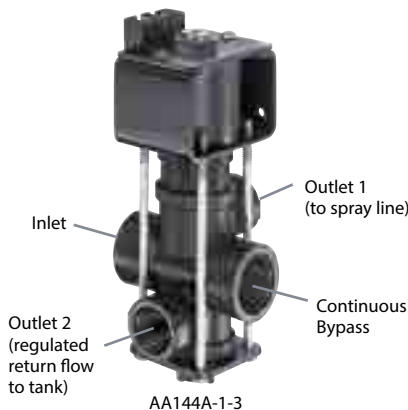

AA144A-1-3





AA(B)344M-NYB

### 344M-NYB 2-WAY NYLON MANUAL BALL VALVES

- Quarter turn of handle from shutoff to full flow.
- $\frac{3}{4}$ " or 1" NPT and BSPT (F) connection.
- Wetted parts: Nylon, PTFE, polypropylene, and FKM.

#### AA(B)344M-NYB

VALVE NUMBER	MAXIMUM PRESSURE (bar)	NUMBER OF OUTLETS	CONNECTION SIZE
AA(B)344M-2-3/4	20	1	$\frac{3}{4}$ "
AA(B)344M-2-1		1	1"

Flow Rate: 0.34 bar pressure drop for 121 l/min flow.

(B) = BSPT



AA(B)343M-PP

### 340M-PP SERIES 2-WAY MANUAL BALL VALVES

- Quarter turn of handle from shutoff to full flow.
- $\frac{3}{8}$ ",  $\frac{1}{2}$ ",  $\frac{3}{4}$ ", 1", 1 $\frac{1}{4}$ " or 1 $\frac{1}{2}$ " NPT and BSPT (F) connection.
- Wetted parts: glass-reinforced polypropylene, PTFE, and FKM.

#### AA(B)343M-PP

VALVE NUMBER	MAXIMUM PRESSURE (bar)	NUMBER OF OUTLETS	CONNECTION SIZE
AA(B)343M-2-3/8-PP	10	1	$\frac{3}{8}$ "
AA(B)343M-2-1/2-PP		1	$\frac{1}{2}$ "

Flow Rate: 0.34 bar pressure drop for 42 l/min flow.

(B) = BSPT



AA(B)344M-PP

#### AA(B)344M-PP

VALVE NUMBER	MAXIMUM PRESSURE (bar)	NUMBER OF OUTLETS	CONNECTION SIZE
AA(B)344M-2-3/4-PP	9	1	$\frac{3}{4}$ "
AA(B)344M-2-1-PP		1	1"

Flow Rate: 0.34 bar pressure drop for 121 l/min flow.

(B) = BSPT



AA(B)346M-PP

#### AA(B)346M-PP

VALVE NUMBER	MAXIMUM PRESSURE (bar)	NUMBER OF OUTLETS	CONNECTION SIZE
AA(B)346M-2-1-1/4-PP	9	1	1 $\frac{1}{4}$ "
AA(B)346M-2-1-1/2-PP		1	1 $\frac{1}{2}$ "

Flow Rate: 0.34 bar pressure drop for 379 l/min flow.

(B) = BSPT



AA(B)344M-NYB

### 344M-NYB 3-WAY NYLON MANUAL BALL VALVES

- 3-way version diverts flow to either outlet; no shutoff.
- 3/4" or 1" NPT and BSPT (F) connection.
- Wetted parts: Nylon, PTFE, polypropylene, and FKM.

#### AA(B)344M-NYB

VALVE NUMBER	MAXIMUM PRESSURE (bar)	NUMBER OF OUTLETS	CONNECTION SIZE
AA(B)344M-3-3/4	20	2	3/4"
AA(B)344M-3-1		2	1"

Flow Rate: 0.34 bar pressure drop for 91 l/min flow.

(B) = BSPT



AA(B)343M-PP

### 340M-PP SERIES 3-WAY MANUAL BALL VALVES

- 3-way version diverts flow to either outlet; no shutoff.
- 3/8", 1/2", 3/4", 1", 1 1/4" or 1 1/2" NPT and BSPT (F) connection.
- Wetted parts: glass-reinforced polypropylene, PTFE, and FKM.

#### AA(B)343M-PP

VALVE NUMBER	MAXIMUM PRESSURE (bar)	NUMBER OF OUTLETS	CONNECTION SIZE
AA(B)343M-3-3/8-PP	10	2	3/8"
AA(B)343M-3-1/2-PP		2	1/2"

Flow Rate: 0.34 bar pressure drop for 30 l/min flow.

(B) = BSPT



AA(B)344M-PP

#### AA(B)344M-PP

VALVE NUMBER	MAXIMUM PRESSURE (bar)	NUMBER OF OUTLETS	CONNECTION SIZE
AA(B)344M-3-3/4-PP	9	2	3/4"
AA(B)344M-3-1-PP		2	1"

Flow Rate: 0.34 bar pressure drop for 91 l/min flow.

(B) = BSPT



AA(B)346M-PP

#### AA(B)346M-PP

VALVE NUMBER	MAXIMUM PRESSURE (bar)	NUMBER OF OUTLETS	CONNECTION SIZE
AA(B)346M-3-1-1/4-PP	9	2	1 1/4"
AA(B)346M-3-1-1/2-PP		2	1 1/2"

Flow Rate: 0.34 bar pressure drop for 242 l/min flow.

(B) = BSPT

### PISTON-TYPE PRESSURE RELIEF/REGULATING VALVES

Bypasses excess liquid. Adjustable to maintain control of line pressure at any pressure within the valve's operating range. Selected pressure setting firmly held in place by locknut. Extra-large valve passages to handle large flows.



23120



6815



110-1/4 &  
110-3/8



110-1, 110-1-1/4  
& 110-1-1/2



8460

### 23120

- 302 stainless steel spring and EPDM O-ring.
- Excellent chemical resistance.
- 1/4" port for pressure gauge pipe plug included.

VALVE NUMBER	INLET & PIPE CONNECTIONS	MATERIAL	PRESSURE RANGE (bar)
(B)23120-*-PP	1/2" or 3/4"	Polypropylene	10
(B)23120A-*-PP	1/2" or 3/4"	Polypropylene	10
(B)23120-*-PP-60	1/2" or 3/4"	Polypropylene	4
(B)23120-*-PP-60-VI	1/2" or 3/4"	Polypropylene	4

\*Specify pipe size.

(B) = BSPT

### 6815

- Other models for high pressures up to 82 bar are also available.
- Also available with hardened stainless steel seat.

VALVE NUMBER	INLET & PIPE CONNECTIONS	MATERIAL	PRESSURE RANGE (bar)
(B)6815-*-50	1/2" or 3/4"	Brass	3.5
(B)6815-*-300	1/2" or 3/4"	Brass	20
(B)6815-*-700	1/2" or 3/4"	Brass	48

\*Specify pipe size.

(B) = BSPT

### 110

- Removable bonnet for servicing unit without removing valve from line.

VALVE NUMBER	INLET & PIPE CONNECTIONS	MATERIAL	PRESSURE RANGE (bar)
AA(B)110-*-50	1/4" or 3/8"	Brass	3.5
AA(B)110-*-150	1/4" or 3/8"	Brass	10
AA(B)110-*-300	1/4" or 3/8"	Brass	20
AA(B)110-*-700	1/4" or 3/8"	Brass	48
AA(B)110-1	1"	Brass, Aluminum or Ductile Iron	10
AA(B)110-1-1/4	1 1/4"	Brass, Aluminum or Ductile Iron	10
AA(B)110-1-1/2	1 1/2"	Brass, Aluminum or Ductile Iron	10

\*Specify pipe size.

(B) = BSPT

### 8460 DIAPHRAGM-TYPE PRESSURE RELIEF/ REGULATING VALVES

- Flow rate to 212 l/min for 1/2" and 265 l/min for 3/4".
- 8460-\*-50 uses stainless steel springs while 8460-\*-300 uses steel springs—responsive to the pressure range of each valve.
- Extra-large valve passages to handle full flow from supply line.
- Positive locknut to hold adjustment screw firmly in place. Not affected by jarring and vibration.

VALVE NUMBER	INLET & PIPE CONNECTIONS	MATERIAL		PRESSURE RANGE (bar)
		INLET BODY	BONNET	
8460-*-50	1/2" or 3/4"	Nylon	Aluminum	3.5
8460-*-300	1/2" or 3/4"	Nylon	Aluminum	20

\*Specify pipe size.

(B) = BSPT

# DirectoValve<sup>®</sup> MANUAL CONTROL VALVE

## AA6B

- Molded of corrosion resistant materials; all wetted parts are polypropylene, stainless steel and polyethylene.
- Maximum pressure of 10 bar.
- Flow Rate: 47 l/min at 0.34 bar pressure drop, 64 l/min at 0.69 bar pressure drop.
- Molded-in mounting flange and ¼" NPT gauge port.
- Valves can be ganged together using hex nipple for multiple boom control.
- Easily repaired without removing valve from spray line.



# TeeValve<sup>®</sup> CONTROL VALVES

## AA17

For selective control of three-section boom sprayers at pressures up to 20 bar.

- Use to open any of three boom section lines in any desired combination.
- Raise lever to open, lower lever to close the valve without changing the indexed position.
- Aluminum construction with stainless steel and plastic internal parts for maximum corrosion resistance.

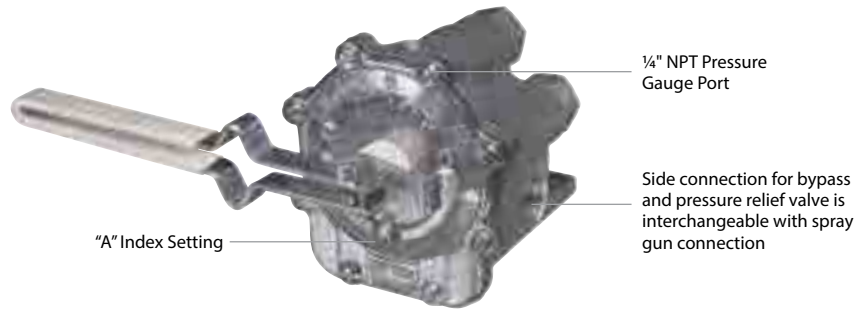

VALVE NUMBER	MATERIAL	MAXIMUM PRESSURE	INLET	(3) BOOM OUTLETS	ACCESSORY OUTLET
AA17Y	Aluminum, Polymer, SS	20 bar	1" NPT	¾" (F)	¾" (F)
AA17L	Aluminum, Polymer, SS	20 bar	¾" NPT	¾" (F)	¾" (F)

# TeeJet<sup>®</sup> THROTTLING VALVES

## 23520, 12690 & 12795

For regulating flow in systems equipped with centrifugal pumps where sensitive regulation is required or to control flow in jet agitator return lines. Locknut holds pressure setting firmly in place.



23520



12795



12690

VALVE NUMBER	INLET & PIPE CONNECTIONS	MATERIAL	PRESSURE RANGE
23520	½" and ¾" NPT or BSPT	Polypropylene	10 bar
12690	½" or ¾" NPT	Nylon, Acetal, Aluminum, Steel, Stainless Steel	9 bar
12795	1", 1¼" or 1½" NPT	Brass, Aluminum, Ductile Iron	10 bar

\*Specify pipe size.

(B) = BSPT

# TeeJet® TIP STRAINERS



## STRAINERS

Strainers protect spray tip orifices from clogging and damage. Stainless steel screens are available in 24, 50, 80, 100 and 200 mesh.

MESH SIZE
16
20
24
25/30
50/60
80
100
120
200

**Note:** Strainers color code follows the ISO 19732 standards.

TEEJET STRAINER NUMBER	STRAINER BODY & CAP MATERIAL	MESH SCREEN MATERIAL
8079-PP-*	Polypropylene	Stainless Steel
5053-SS	Brass	Stainless Steel
6051-SS-*	Stainless Steel	Stainless Steel

\*Specify mesh size when ordering.

## 55215 SELF-RETAINING TIP STRAINER

For use with Quick TeeJet caps. Allows tip strainer to be easily removed from nozzle body for cleaning. 50 or 100 mesh color-coded strainer with optional EPDM or FKM gasket.



### HOW TO ORDER

55215-50-EPR, EPDM gasket  
55215-50-VI, FKM gasket

STRAINER NUMBER	MESH
55215-50-*	50
55215-100-*	100

\*Identify gasket material.

## SLOTTED STRAINERS

One-piece strainers for use with liquids containing suspended solids.



TEEJET STRAINER NUMBER	AVAILABLE MATERIAL	EQUIVALENT TO MESH SIZE	COLOR CODE (NYLON VERSIONS ONLY)
4514-*-10	Brass or Nylon	50	50
4514-*-20	Brass, Aluminum or Nylon	25	25
4514-*-32	Brass, Aluminum or Nylon	16	16

\*Above numbers for brass. For Nylon add "NY". For aluminum add "AL".

## 4193A & 4193B STRAINER & CHECK VALVE

Minimizes nozzle dripping; fits with all TeeJet Nozzle Bodies. 4193B offered with a choice of 0.64 bar or 0.69 bar, 4193A offered with a choice of 1.4 bar or 2.8 bar spring. Recommended for flow rates up to 3 l/min. 24, 50, 100 and 200 mesh screens. Not for use with AI, DG, or TTI tips.



**Note:** Use of these ball check valves results in a pressure drop equivalent to the opening pressure rating.

CHECK VALVE NUMBER	BODY & CAP SCREW MATERIAL	MESH SCREEN MATERIAL	BALL MATERIAL
4193A/B- *- *	Brass	Stainless Steel	Stainless Steel
4193A/B-SS- *- *	Stainless Steel	Stainless Steel	Stainless Steel
4193A/B-PP- *- *	Polypropylene	Stainless Steel	FKM
4193A/B-PP-SS-*	Polypropylene	Stainless Steel	Stainless Steel

\*When ordering, specify A or B, spring rating and screen mesh size.

# TeeJet® LINE STRAINERS

The AA122 line strainer features a compact size that is well suited for small agricultural and turf sprayers. The AA122 is constructed of a polypropylene head and bowl with stainless steel screen for excellent chemical resistance and is available with 1/2" or 3/4" (F) NPT pipe connections.

The maximum pressure rating is 10 bar. A Quick Connect version of the 122 is also available for easy installation on valves/manifolds equipped with Quick Connect outlets. The maximum pressure rating for this version is 15 bar.



23174  
28 mm O.D.  
69 mm Length



45102  
30 mm O.D.  
70 mm Length



AA122ML-QC  
Compact Liquid Strainer



AA122-PP  
Compact Liquid Strainer



37270-122-PP  
Flush-Out Strainer

## 37270-122-PP

The screen may be periodically flushed by opening a valve (valve not included) in flush-out line.

STRAINER NUMBER	PIPE CONN.	APPROXIMATE FLOW RATE WITH 0.34 bar PRESSURE DROP IN l/min	SCREEN	
			MESH SIZE	PART NUMBER
AA122ML-QC-PP-*	QC	68		
AA(B)122-1/2-PP-*	1/2"	45	16	CP23174-1-3045S
AA(B)122-3/4-PP-*	3/4"	60	30	CP23174-2-3045S
AA(B)122ML-1/2-PP-*	1/2"	45	50	CP45102-3-SSPP
AA(B)122ML-3/4-PP-*	3/4"	60	80	CP45102-4-SSPP
(B)37270-122-1/2-PP-*	1/2"	45	100	CP45102-5-SSPP
(B)37270-122-3/4-PP-*	3/4"	60	200	CP23174-7-3045S

\* = Mesh Size

(B) = BSPT

**Replacement Head Gasket:** CP23173-EPR(-VI) or CP7717-M38x4-VI (for AA122ML-QC only).

**Note:** Strainers color code follows the ISO 19732 standards.



AA126ML-F50



AA126ML-3 or -4

**AA126 FLUSH-OUT LINE STRAINER**

- 14 bar maximum pressure rating.
- Strainer head and bowl are made of glass-filled polypropylene with EPDM gasket.
- Screens are made of 304SS with color-coded polypropylene frames and are removable for cleaning.
- Removable cap and O-ring for flush-out or self-cleaning operations.
- Integral mounting provision allows the strainer to be attached to machine using M8 or 5/16" diameter bolts.
- Available with 3/4", 1" NPT or BSPT (F) threads and 50 series flange fitting connections for easy assembly. For information on flange fittings see page 158.
- Uses same screen as the AA124A line strainer.



16903  
35 mm O.D.  
146 mm Length

STRAINER NUMBER	PIPE/FLANGE CONNECTION (F)	FLOW RATE WITH 0.34 bar PRESSURE DROP	SCREEN	MESH SIZE*
AA(B)126ML-F50-*	50 Series Flange	132 l/min	CP16903-1-SSPP	16
			CP16903-3-SSPP	30
AA(B)126ML-3-*	3/4"	87 l/min	CP16903-4-SSPP	50
			CP16903-5-SSPP	80
AA(B)126ML-4-*	1"	132 l/min	CP16903-6-SSPP	100
			CP16903-7-SSPP	200

\*Specify mesh size

**Replacement Head Gasket:** CP7717-2/228-EPR (-VI)

**Note:** Strainers color code follows the ISO 19732 standards.



AA126ML-F75



AA126ML-5 or -6

**AA126 FLUSH-OUT LINE STRAINER**

- 14 bar maximum pressure rating.
- Strainer head and bowl are made of glass-filled polypropylene with EPDM gasket.
- Screens are made of 304SS with color-coded polypropylene frames and are removable for cleaning.
- Removable cap and gasket for flush-out or self-cleaning operations.
- Integral mounting provision allows the strainer to be attached to machine using M10 or 3/8" diameter bolts.
- Available with 1 1/4", 1 1/2" NPT or BSPT (F) threads and 75 series flange fitting connections for easy assembly. For information on flange fittings see page 158.
- Uses same screen as the AA124 line strainer.



15941  
57 mm O.D.  
194 mm Length

STRAINER NUMBER	PIPE/FLANGE CONNECTION (F)	FLOW RATE WITH 0.34 bar PRESSURE DROP	SCREEN	MESH SIZE*
AA(B)126ML-F75-*	75 Series Flange	291 l/min	CP15941-1-SSPP	16
			CP15941-2-SSPP	30
AA(B)126ML-5-*	1 1/4"	223 l/min	CP15941-3-SSPP	50
			CP15941-4-SSPP	80
AA(B)126ML-6-*	1 1/2"	291 l/min	CP15941-5-SSPP	100
			CP15941-6-SSPP	120

\*Specify mesh size

**Replacement Head Gasket:** CP48656-EPR(-VI)

**Note:** Strainers color code follows the ISO 19732 standards.



## SELF-CLEANING LINE STRAINERS

The TeeJet self-cleaning strainer extends your spraying time with a self-cleaning feature that minimizes clogging. Mounted on the discharge side of the pump, the strainer uses excess pump flow to bypass clogging particles back to the spray tank.

The tapered inner cylinder inside the entire length of the screen provides a gap between the screen face and the cylinder. This gap causes the inlet fluid to flow at a high velocity past the screen face providing for a continuous wash down of particles to the bypass line. In order for the wash down to occur, a minimum flow rate of 23 l/min for ¾" and 1" sizes and 30 l/min for 1¼" and 1½" sizes is required through the bypass line.

- Available with or without mounting lugs.
- AA126 strainers are made of glass filled polypropylene and are available in ¾", 1", 1¼", 1½" (F) NPT or BSPT thread as well as 50 and 75 series flange connection.
- AA124 strainers are made of an aluminum head with a nylon bowl and are available in ¾", 1", 1¼", 1½" (F) NPT or BSPT thread.
- Both use an all stainless steel strainer element.
- Strainers with mounting lugs are designated by "ML".



AA(B)126MLSC  
(Glass-filled Polypropylene)



AA(B)124ML-SC-AL  
(Aluminum)



AA(B)124-SC-AL  
(Aluminum)

STRAINER NUMBER	PIPE CONN.	BYPASS PIPE CONN.	MATERIAL		MAX. PRESSURE (bar)	MIN. BYPASS REQUIRED (l/min)	SCREEN		
			HEAD	BOWL			MESH	NUMBER	
AA(B)126MLSC-3-*	¾" (F)	½" (F)	Polypropylene		14	23	16	CP12285-*SS	
AA(B)124ML-3/4SC-AL-*			Aluminum	Nylon	10		30		
AA(B)126MLSC-4-*	1" (F)		Polypropylene		14		50		80
AA(B)124ML-1SC-AL-*			Aluminum	Nylon	10				
AA(B)126MLSC-F50-*	Flange	¾" (F)	Polypropylene		14	30	100	CP12290-*SS	
AA(B)126MLSC-5-*	1¼" (F)		Polypropylene		14				
AA(B)124ML-1-1/4SC-AL-*		1½" (F)	Aluminum	Nylon	10	100			
AA(B)126MLSC-6-*	Polypropylene		14						
AA(B)124ML-1-1/2SC-AL-*	Flange	Polypropylene		14					
AA(B)126MLSC-F75-*		Polypropylene		14					

**Replacement Head Gaskets:** 126-3, -4, -F50: CP50494-EPR (-VI); 126-5, -6, -F75: CP48656-VI; 124-3/4, -1: CP7717-2/226-VI; 124-1-1/4, -1-1/2: CP12291-VI

STRAINER NUMBER	PIPE CONN.	BYPASS PIPE CONN.	MATERIAL		MAX. PRESSURE (bar)	MIN. BYPASS REQUIRED (l/min)	SCREEN		
			HEAD	BOWL			MESH	NUMBER	
AA(B)124A-3/4SC-AL-*	¾" (F)	½" (F)	Aluminum	Nylon	10	23	16	CP12285-*SS	
AA(B)124A-1SC-AL-*	1" (F)						30		
AA(B)124A-1-1/4SC-AL-*	1¼" (F)	80					30		CP12290-*SS
AA(B)124A-1-1/2SC-AL-*	1½" (F)								

## HOW TO ORDER

AA126MLSC-4-50

Specify strainer number.

CP12285-1-SS

To order screen only, specify screen number.

SCREEN		
MESH	SCREEN NUMBER	SCREEN NUMBER
16	CP12285-1-SS	CP12290-1-SS
30	CP12285-4-SS	CP12290-2-SS
50	CP12285-2-SS	CP12290-3-SS
80	CP12285-3-SS	CP12290-4-SS
100	CP12285-6-SS	CP12290-8-SS



12285  
35 mm O.D.  
146 mm Length



12290  
57 mm O.D.  
202 mm Length

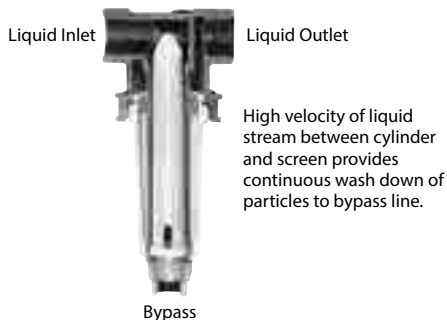

High velocity of liquid stream between cylinder and screen provides continuous wash down of particles to bypass line.

Bypass

Strainer heads are available in aluminum and cast iron. Bowl material is Nylon. Each strainer includes stainless steel screen (with polypropylene frames on 3/4" to 1 1/2" pipe sizes). Maximum temperatures up to 38°C. FKM O-ring seal supplied with 3/4" and 1" models; Buna-N gaskets supplied with 1 1/4", 1 1/2", 2" and 2 1/2" sizes. FKM optional.



AA(B)124A-AL



16903  
35 mm O.D.  
146 mm Length



AA(B)124-AL



15941  
57 mm O.D.  
194 mm Length



14634  
81 mm O.D.  
248 mm Length



AA(B)124ML-AL  
(with mounting holes)



16903  
35 mm O.D.  
146 mm Length



15941  
57 mm O.D.  
194 mm Length



14634  
81 mm O.D.  
248 mm Length

## HOW TO ORDER

AA(B)124-1-1/4-NYB-16 (Nylon)  
Specify strainer number, mesh size and material.

CP15941-1-SSPP

To order screen only, specify screen number.

STRAINER NUMBER	PIPE CONN.	APPROXIMATE FLOW RATE WITH 0.34 bar PRESSURE DROP IN l/min	PRESSURE RATING (bar)	SCREEN	
				MESH SIZE	PART NUMBER
AA(B)124A-3/4-AL*	3/4"	87	10	16	CP16903-1-SSPP
				20	CP16903-2-SSPP
				30	CP16903-3-SSPP
				50	CP16903-4-SSPP
AA(B)124A-1-AL*	1"	129	10	80	CP16903-5-SSPP
				100	CP16903-6-SSPP
				200	CP16903-7-SSPP

\* = Mesh Size

(B) = BSPT

Replacement Head O-Ring: CP7717-2/226-VI

STRAINER NUMBER	PIPE CONN.	APPROXIMATE FLOW RATE WITH 0.34 bar PRESSURE DROP IN l/min	PRESSURE RATING (bar)	SCREEN	
				MESH SIZE	PART NUMBER
AA(B)124-1-1/4-AL*	1 1/4"	230	10	16	CP15941-1-SSPP
				30	CP15941-2-SSPP
				50	CP15941-3-SSPP
AA(B)124-1-1/2-AL*	1 1/2"	260	10	80	CP15941-4-SSPP
				100	CP15941-5-SSPP
				120	CP15941-6-SSPP
AA(B)124-2-AL*	2"	610	10	16	CP14634-1-SS
				30	CP14634-2-SS
AA(B)124-2-1/2-AL*	2 1/2"	640	10	50	CP14634-3-SS
				80	CP14634-4-SS
				100	CP14634-8-SS

\* = Mesh Size

(B) = BSPT

Replacement Head Gasket: 124-1-1/4, 1-1/2: CP12291-BU(-VI);  
124-2, -2-1/2: CP14833-BU

STRAINER NUMBER	PIPE CONN.	APPROXIMATE FLOW RATE WITH 0.34 bar PRESSURE DROP IN l/min	PRESSURE RATING (bar)	SCREEN	
				MESH SIZE	PART NUMBER
AA(B)124ML-3/4-AL*	3/4"	87	10	16	CP16903-1-SSPP
				20	CP16903-2-SSPP
				30	CP16903-3-SSPP
				50	CP16903-4-SSPP
AA(B)124ML-1-AL*	1"	129	10	80	CP16903-5-SSPP
				100	CP16903-6-SSPP
				200	CP16903-7-SSPP
AA(B)124ML-1-1/4-AL*	1 1/4"	230	10	16	CP15941-1-SSPP
				30	CP15941-2-SSPP
				50	CP15941-3-SSPP
AA(B)124ML-1-1/2-AL*	1 1/2"	260	10	80	CP15941-4-SSPP
				100	CP15941-5-SSPP
				120	CP15941-6-SSPP
AA(B)124ML-2-AL*	2"	610	10	16	CP14634-1-SS
				30	CP14634-2-SS
AA(B)124ML-2-1/2-AL*	2 1/2"	640	10	50	CP14634-3-SS
				80	CP14634-4-SS
				100	CP14634-8-SS

\* = Mesh Size

(B) = BSPT

For spot spraying, tree spraying, and livestock spraying at pressures from 2 to 55 bar.

To operate spray gun, handle is rotated 360° from shutoff to maximum flow position. As handle is turned, spray changes from initial cone spray through intermediate cone spray to straight stream. Spray tips are interchangeable orifice discs made of corrosion- and erosion-resistant stainless steel.

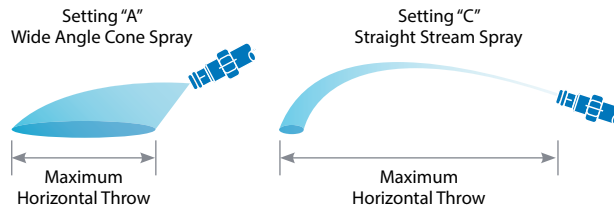

## AA143

Overall length 565 mm, weight 0.57 kg and only available in aluminum. Inlets are available with 3/4" or GH (garden hose) female threads.



### HOW TO ORDER

AA143-AL-3/4-6

AA143-AL-GH-6

D 2

To order orifice disc only, specify orifice disc number.

GUNJET NUMBER	ORIFICE DISC NUMBER	PERFORMANCE	LIQUID PRESSURE IN BAR			
			7 bar		55 bar	
			A	C	A	C
AA143-AL*-2	D2	Capacity (l/min)	1.7	1.8	4.9	4.9
		Max. Vert. Throw (m)	—	6.7	—	7.9
		Max. Horiz. Throw (m)	3.0	10.1	3.4	10.7
AA143-AL*-4	D4	Capacity (l/min)	3.5	3.6	9.8	10.2
		Max. Vert. Throw (m)	—	8.2	—	9.8
		Max. Horiz. Throw (m)	3.0	11.0	3.4	12.2
AA143-AL*-6	D6	Capacity (l/min)	7.2	7.6	20.0	21.9
		Max. Vert. Throw (m)	—	10.1	—	11.6
		Max. Horiz. Throw (m)	3.0	13.7	3.4	15.2
AA143-AL*-8	D8	Capacity (l/min)	11.8	13.0	33.3	36.3
		Max. Vert. Throw (m)	—	10.8	—	12.8
		Max. Horiz. Throw (m)	3.0	14.0	3.4	15.5
AA143-AL*-10	D10	Capacity (l/min)	15.6	19.1	38.5	53.3
		Max. Vert. Throw (m)	—	11.4	—	13.6
		Max. Horiz. Throw (m)	3.2	14.9	3.7	16.5

\*Inlet size 3/4" or GH.

## AA18

Overall length 508 mm, weight 0.45 kg, aluminum. 1/4 NPT (F) inlet connection. Also available in brass.



### HOW TO ORDER

AA18-AL2

Aluminum

AA18-2

Brass

D 2

To order orifice disc only, specify orifice disc number.

GUNJET NUMBER	ORIFICE DISC NUMBER	PERFORMANCE	LIQUID PRESSURE IN BAR			
			7 bar		55 bar	
			A	C	A	C
AA18-AL2	D2	Capacity (l/min)	1.7	1.8	4.9	4.9
		Max. Vert. Throw (m)	—	6.7	—	7.9
		Max. Horiz. Throw (m)	3.0	10.1	3.4	10.7
AA18-AL4	D4	Capacity (l/min)	3.5	3.6	9.8	10.2
		Max. Vert. Throw (m)	—	8.2	—	9.8
		Max. Horiz. Throw (m)	3.0	11.0	3.4	12.2
AA18-AL6	D6	Capacity (l/min)	7.2	7.6	20.0	21.9
		Max. Vert. Throw (m)	—	10.1	—	11.6
		Max. Horiz. Throw (m)	3.0	13.7	3.4	15.2
AA18-AL8	D8	Capacity (l/min)	11.8	13.0	33.3	36.3
		Max. Vert. Throw (m)	—	10.8	—	12.8
		Max. Horiz. Throw (m)	3.0	14.0	3.4	15.5
AA18-AL10	D10	Capacity (l/min)	15.6	19.1	38.5	53.3
		Max. Vert. Throw (m)	—	11.4	—	13.6
		Max. Horiz. Throw (m)	3.2	14.9	3.7	16.5

## AA2

Overall length 610 mm, weight 1.6 kg, brass. 3/4" garden hose thread (F) inlet connection. Also available in aluminum as GunJet AA2-AL, weight 0.57 kg.



## AA2A

Overall length 381 mm, weight 1.1 kg, brass. 3/4" garden hose thread (F) inlet connection. Also available in aluminum as GunJet AA2A-AL, weight 0.45 kg. Same design as GunJet AA2.



### HOW TO ORDER

**A A 2 - 2 0**

Brass

**A A 2 - A L 2 0**

Aluminum

**A Y - S S 2 0**

To order orifice disc only, specify orifice disc number.

GUNJET NUMBER	ORIFICE DISC NUMBER	PERFORMANCE	LIQUID PRESSURE IN BAR			
			7 bar		55 bar	
			A	C	A	C
AA2-20	AY-SS 20	Capacity (l/min)	2.0	3.5	5.8	9.6
		Max. Vert. Throw (m)	—	7.5	—	10
		Max. Horiz. Throw (m)	2	10.5	2.5	12.5
AA2-30	AY-SS 30	Capacity (l/min)	3.0	5.4	8.5	15.4
		Max. Vert. Throw (m)	—	8	—	10
		Max. Horiz. Throw (m)	2	11.5	2.5	13.5
AA2-45	AY-SS 45	Capacity (l/min)	4.6	8.9	13.0	25.0
		Max. Vert. Throw (m)	—	9	—	11
		Max. Horiz. Throw (m)	2.5	12.5	2.5	14.5
AA2-60	AY-SS 60	Capacity (l/min)	6.2	13.9	17.3	38.5
		Max. Vert. Throw (m)	—	9.5	—	12
		Max. Horiz. Throw (m)	2.5	13.5	3	15.5
AA2-90	AY-SS 90	Capacity (l/min)	8.9	18.9	25.8	53.9
		Max. Vert. Throw (m)	—	10.5	—	13
		Max. Horiz. Throw (m)	3	14.5	3.5	17.5
AA2-120	AY-SS 120	Capacity (l/min)	12.3	24.6	34.6	65.4
		Max. Vert. Throw (m)	—	11	—	14.5
		Max. Horiz. Throw (m)	3.5	15	4	19
AA2-180	AY-SS 180	Capacity (l/min)	18.1	42.3	50.0	119.0
		Max. Vert. Throw (m)	—	11	—	14.5
		Max. Horiz. Throw (m)	3.5	15	4.5	19



# GunJet® SPRAY GUNS



## AA43 GUNJET

Designed and built for heavy-duty service. Stem extends through extension to valve seat located directly behind orifice disc for drip-free shutoff and instant operating response. Convenient trigger-lock for continuous spraying.

- Number AA43L for operating pressures up to 14 bar.
- Number AA43H for operating pressures up to 55 bar.
- Trigger handle control: All models have ½" NPT or BSPT (F) inlet connections.
- Exposed packing nut for easy adjustment of packing.
- Available in aluminum or brass.

## 43L & 43H

MODEL NUMBER	OPERATING PRESSURE RANGE (bar)	MATERIAL	OVERALL LENGTH (mm)
AA(B)43L-AL	0-14	Aluminum	559
AA(B)43H-AL	14-55	Aluminum	

(B) = BSPT

## HARDENED STAINLESS STEEL TYPE D ORIFICE DISCS

Choose one of five interchangeable orifice disc capacities. Other sizes may be available upon request. Discs are corrosion and erosion-resistant.



## HARDENED STAINLESS STEEL TYPE DX-HSS SPRAY TIPS

For spraying trees and other applications where maximum spray throw is required.



## 43A

MODEL NUMBER	OPERATING PRESSURE RANGE (bar)	MATERIAL	OVERALL LENGTH (mm)
AA(B)43LA-AL	0-14	Aluminum	330
AA(B)43HA-AL	14-55	Aluminum	

(B) = BSPT

Types 43LC-1/2 and 43HC-1/2 have ½" NPT (F) outlet connections. Inlet connections are ½" NPT or BSPT (F).

## 43LC-1/2 & 43HC-1/2

MODEL NUMBER	OPERATING PRESSURE RANGE (bar)	MATERIAL	OVERALL LENGTH (mm)
AA(B)43LC-1/2	0-14	Brass	203
AA(B)43HC-1/2	14-55	Brass	

(B) = BSPT

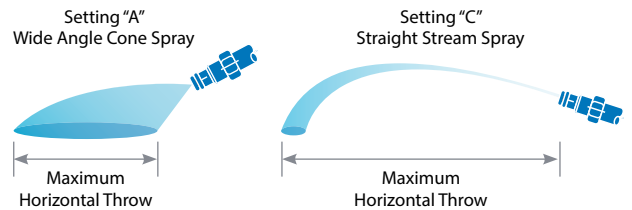

As trigger is drawn back, valve moves from shutoff position to initial wide angle spray, to continuously narrower cone sprays, to final straight stream. Knurled ring behind trigger is adjustable to stop trigger at any desired position.

## HOW TO ORDER

AA(B)43L-AL4 (Aluminum)

Specify complete GunJet spray gun number and material.

GUNJET NUMBER	ORIFICE DISC NUMBER	PERFORMANCE	LIQUID PRESSURE IN BAR									
			3 bar		7 bar		14 bar		28 bar		55 bar	
			A	C	A	C	A	C	A	C	A	C
AA(B)43L-AL2 AA(B)43H-AL2	D2	Capacity (l/min)	1.1	1.2	1.7	1.8	2.4	2.5	3.4	3.6	4.9	4.9
		Max. Vert. Throw (m)	—	6.7	—	6.7	—	7.0	—	7.3	—	7.9
		Max. Horiz. Throw (m)	3.0	9.8	3.0	10.1	3.0	10.4	3.2	10.7	3.4	10.7
AA(B)43L-AL4 AA(B)43H-AL4	D4	Capacity (l/min)	2.4	2.4	3.5	3.6	5.0	5.0	6.9	7.2	9.8	10.2
		Max. Vert. Throw (m)	—	7.9	—	8.2	—	8.5	—	9.1	—	9.8
		Max. Horiz. Throw (m)	3.0	11.0	3.0	11.0	3.2	11.3	3.4	11.9	3.4	12.2
AA(B)43L-AL6 AA(B)43H-AL6	D6	Capacity (l/min)	4.7	5.1	7.2	7.6	10.3	11.1	14.5	15.6	20.0	21.9
		Max. Vert. Throw (m)	—	9.6	—	10.1	—	10.5	—	11.1	—	11.6
		Max. Horiz. Throw (m)	3.0	13.4	3.0	13.7	3.2	14.0	3.4	14.6	3.4	15.2
AA(B)43L-AL8 AA(B)43H-AL8	D8	Capacity (l/min)	7.9	9.9	11.8	13.0	16.8	18.3	23.6	37.4	33.3	36.3
		Max. Vert. Throw (m)	—	10.1	—	10.8	—	11.6	—	12.3	—	12.8
		Max. Horiz. Throw (m)	3.0	13.7	3.0	14.0	3.2	14.3	3.4	14.9	3.4	15.5
AA(B)43L-AL10 AA(B)43H-AL10	D10	Capacity (l/min)	10.3	12.6	15.6	19.1	22.1	27.1	31.3	38.1	38.5	53.3
		Max. Vert. Throw (m)	—	10.7	—	11.4	—	12.2	—	13.0	—	13.6
		Max. Horiz. Throw (m)	3.0	14.0	3.2	14.9	3.4	15.2	3.5	15.8	3.7	16.5

(B) = BSPT

## 25660

- Interchangeable nozzle tips are color-coded for easy identification of nozzle tip size.
- Nozzle tips provide a 45° full cone “showerhead” spray pattern.
- Convenient trigger lock for continuous spraying.
- Options available: hose shank swivel for inlet connection and extension wand and adapters for low-volume and spot spraying.
- Maximum operating pressure of 14 bar.
- Made of Nylon with FKM O-rings and stainless steel springs.



MODEL NUMBER	NOZZLE TIP NUMBER	CAPACITY (l/min) AT VARIOUS PRESSURE*						
		0.15 bar	0.3 bar	0.4 bar	0.6 bar	0.7 bar	1 bar	1.5 bar
25660-1.5	CP25670-1.5-NY	5.4	7.5	8.4	10.2	10.9	12.8	15.7
25660-3.0	CP25670-3.0-NYB	7.8	10.6	11.9	14.4	15.5	18.2	22.0
25660-4.0	CP25670-4.0-NY	9.1	12.4	13.9	17.0	17.8	20.9	25.4

\*Pressure measured at spray nozzle. For gun without spray tip, order 25660-0.

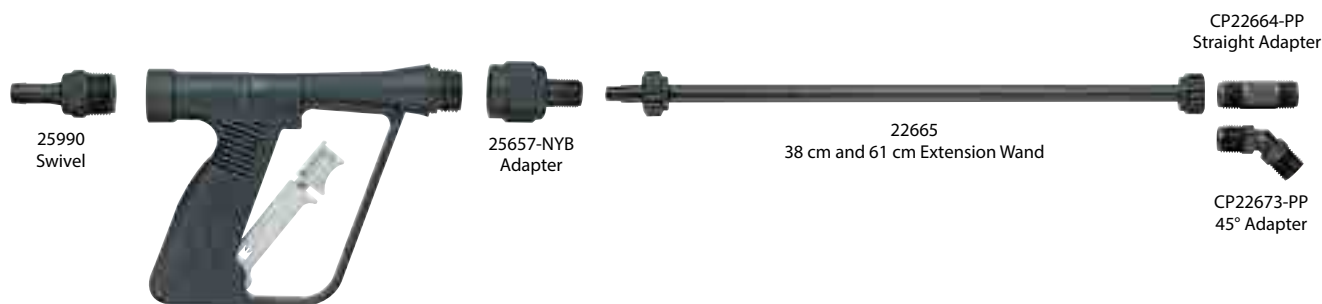

## 25990 SWIVEL

Allows operator to concentrate on application without hose interference. 3/4" (M) NPT connection with 1/2" hose shank. Maximum pressure 10 bar.

## 25657-NYB ADAPTER

Replaces shower nozzle to allow extension wand or standard TeeJet tip to be attached directly to lawn spray gun. 3/4" (F) GHT inlet with 1/16"-16 TeeJet thread outlet. Maximum pressure 10 bar. See page 177 for adjustable ConeJet® nozzles.

## 22665 EXTENSION WAND

For low volume and spot spraying applications. Available in both 38 cm and 61 cm lengths, the extension fits on 25657-NYB adapter. Maximum pressure 10 bar.

## CP22673-PP & CP22664-PP ADAPTERS

Used for attaching standard TeeJet tips or adjustable ConeJet nozzles. See page 177 for adjustable ConeJet nozzles.



## PW4000A

The model PW4000A GunJet is a durable high-pressure spray gun that offers comfort and control. Trigger locks into an off position to prevent accidental discharge. The PW4000A operates at up to 275 bar and provides flow rates up to 38 l/min. Liquid temperatures up to 150°C. Available with 1/4" or 3/8" NPT or BSPT inlet and outlet connections.



## AA30A

Maximum pressure rating of 105 bar with 19 l/min up to 93°C and 1/4" (F) NPT or BSPT inlet thread. Materials including Nylon handles and trigger guards, forged brass valve bodies, Buna-N or FKM stem seals, PTFE valve seats and stainless steel working parts mean long, productive equipment life.

### HOW TO ORDER

AA(B)30A - 1/4

(B)=BSPT

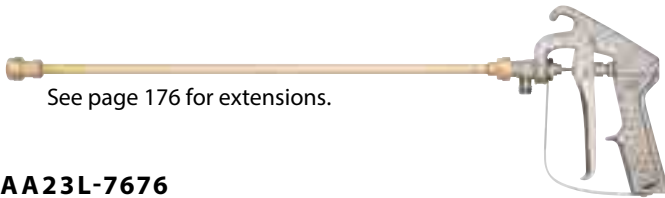

See page 176 for extensions.

## AA23L-7676

The AA23L-7676 GunJet spray gun (shown above) is also available without extension as GunJet spray gun AA23L. Flow rates up to 19 l/min. Maximum operating pressure of 17 bar. Inlet 1/4" NPS (M) thread. Strong aluminum alloy body. When used with extension, the valve stem extends through the entire extension length for drip-free shutoff immediately behind the spray tip. Accommodates all interchangeable TeeJet spray tips.

GUNJET NUMBER	EXTENSION LENGTH (mm)
AA23L	Without Extension
AA23L-7676-8	203
AA23L-7676-18	457
AA23L-7676-24	610
AA23L-7676-36	914
AA23L-7676-48	1,219

### HOW TO ORDER

AA23L



### HOW TO ORDER

(B)PW4000A

3/8" inlet and 1/4" outlet

(B)PW4000A - 1/4 x 1/4

1/4" inlet and outlet

(B)PW4000A - 3/8 x 3/8

3/8" inlet and outlet

(B)=BSPT

## AA30L-PP

This version of the standard AA30L GunJet spray gun is constructed of polypropylene for excellent corrosion resistance. The maximum pressure rating is 10 bar with flow rates up to 19 l/min. Liquid inlet connection available in 1/4" (F) NPT or BSPT. Wetted parts are polypropylene, stainless steel and FKM.



### HOW TO ORDER

AA(B)30L - PP

(B)=BSPT



## AA30L-22425

The AA30L-22425 GunJet spray gun (shown above) is also available without extension as GunJet spray gun AA30L. Flow rates up to 19 l/min. Maximum operating pressure of 17 bar. Outlet connection is 1/16"-16 TeeJet thread. Body and trigger molded of tough Nylon. When used with extension, the valve stem extends through the entire extension length for drip-free shutoff immediately behind the spray tip. Accommodates all interchangeable TeeJet spray tips.

GUNJET NUMBER	EXTENSION LENGTH (mm)
AA(B)30L-1/4	Without Extension
AA(B)30L-22425-8	203
AA(B)30L-22425-18	457
AA(B)30L-22425-24	610
AA(B)30L-22425-36	914
AA(B)30L-22425-48	1,219

### HOW TO ORDER

AA(B)30L - 1/4



(B)=BSPT



## 50800

The 50800 TriggerJet spray gun is a lightweight spray gun designed for use with backpack, canister or other low-pressure sprayers. The TriggerJet is made of molded polypropylene for excellent chemical resistance and durability.

- Available with 381 mm polypropylene or 533 mm aluminum extension wand.
- Available with 38720-PPB-X18 or X26 adjustable ConeJet® tips with a 30° offset.
- Trigger lock permits locking gun in an open position for continuous flow.
- Maximum operating pressure of 7 bar.
- ¼" or ⅜" hose shank connection.
- Approximate max. hose O.D. – 13 mm.
- Polypropylene strainer located inside handle to prevent tip clogging.

MODEL NUMBER	DESCRIPTION	INLET CONNECTION	TIP NUMBER
50800-15-PP-300	381 mm Polypropylene Extension	¼" Hose Barb Inlet	 <b>38720-PPB-X18</b>
50800-15-PP-406		⅜" Hose Barb Inlet	
50800-21-AL-300	533 mm Aluminum Extension	¼" Hose Barb Inlet	
50800-21-AL-406		⅜" Hose Barb Inlet	
50800-15-PP-300-X26	381 mm Polypropylene Extension	¼" Hose Barb Inlet	 <b>38720-PPB-X26</b>
50800-15-PP-406-X26		⅜" Hose Barb Inlet	
50800-21-AL-300-X26	533 mm Aluminum Extension	¼" Hose Barb Inlet	
50800-21-AL-406-X26		⅜" Hose Barb Inlet	
CP50786-PP-300	Replacement Inlet Fitting	¼" Hose Barb Inlet	
CP50786-PP-406		⅜" Hose Barb Inlet	



## 50800 TRIGGERJET LESS EXTENSION & TIP

- Can be fitted with any standard TeeJet tip.

MODEL NUMBER	DESCRIPTION	INLET CONNECTION
50800-PP-300	TriggerJet, Less Extension	¼" Hose Barb Inlet
50800-PP-406	TriggerJet, Less Extension	⅜" Hose Barb Inlet



## 22670

The 22670 TriggerJet spray gun kit combines the 22650 TriggerJet spray gun with an extension wand, adapter, and adjustable ConeJet spray tip. Maximum pressure rating is 10 bar.

- 22650 TriggerJet spray gun with choice of 1/4" or 3/8" hose shank and a 1/4" NPT or BSPT (F) thread inlet connection.

- Trigger lock permits locking gun in an open position for continuous flow (optional).
- 22665 extension wand with choice of 381 mm or 610 mm lengths.

- 38720-PPB-X8 adjustable ConeJet® spray tip with Viton® O-ring.
- Accepts all standard TeeJet spray tips and tip strainers.

### HOW TO ORDER

(B) 22670-PP-15-1/4

Reference page 177 for additional spray tip information.

MODEL NUMBER	EXTENSION LENGTH	INLET CONNECTION	TIP NUMBER
(B)22670-PP-15-1/4	38 cm	1/4" (F)	 <b>38720-PPB-X8</b> (Standard tip shipped with TriggerJet)
22670-PP-15-300	38 cm	1/4" Hose Shank	
22670-PP-15-406	38 cm	3/8" Hose Shank	
(B)22670-PP-24-1/4	61 cm	1/4" (F)	
22670-PP-24-300	61 cm	1/4" Hose Shank	
22670-PP-24-406	61 cm	3/8" Hose Shank	

(B)=BSPT

## 22650

The 22650 TriggerJet spray gun is a lightweight spray gun designed for use with backpack, canister or other low-pressure sprayers. The TriggerJet is made of molded polypropylene for excellent chemical resistance and durability.

- Choice of 1/4" or 3/8" hose shank and 1/4" NPT or BSPT (F) thread inlet connection.

- Replaceable diaphragm made of FKM.
- Trigger lock permits locking gun in an open position for continuous flow (optional).
- Maximum operating pressure of 10 bar.
- Accepts all standard TeeJet spray tips and tip strainers.



### HOW TO ORDER

(B) 22650-PP-1/4

Reference page 177 for additional spray tip information.

MODEL NUMBER	EXTENSION LENGTH	INLET CONNECTION	TIP NUMBER
(B)22650-PP-1/4	None	1/4" (F)	None
22650-PP-300		1/4" Hose Shank	
22650-PP-406		3/8" Hose Shank	

(B)=BSPT

# ConeJet® ADJUSTABLE SPRAY TIPS

## 38720-PP

- Provides adjustable spray from solid stream to a hollow cone pattern.
- Made of polypropylene material for excellent chemical resistance.
- Fits any 1/16"-16 TeeJet® male thread bodies.
- 30° offset from horizontal incorporated into main tip body.



ADJUSTABLE CONEJET TIP NUMBER	PERFORMANCE	LIQUID PRESSURE IN BAR									
		1.5 bar		2 bar		3 bar		4 bar		7 bar	
		SETTING		SETTING		SETTING		SETTING		SETTING	
		A	B	A	B	A	B	A	B	A	B
38720-PPB-X8	Capacity (l/min)	0.37	1.2	0.45	1.5	0.49	1.8	0.61	2.2	0.79	2.8
	Spray Angle	66°	—	71°	—	74°	—	77°	—	80°	—
	Max. Throw (m)	1	10	1	11	1	12	1	12	1.2	12
38720-PPB-X12	Capacity (l/min)	0.57	1.9	0.68	2.3	0.76	2.6	0.91	3.2	1.2	4.2
	Spray Angle	71°	—	75°	—	77°	—	78°	—	80°	—
	Max. Throw (m)	1.1	11	1.2	12	1.2	12	1.2	12	1.2	12
38720-PPB-X18	Capacity (l/min)	0.75	2.6	0.91	3.1	1.1	3.5	1.3	4.2	1.6	5.3
	Spray Angle	61°	—	68°	—	80°	—	80°	—	80°	—
	Max. Throw (m)	1.2	12	1.2	13	1.2	13	1.2	13	1.8	13
38720-PPB-X26	Capacity (l/min)	1.2	3.4	1.4	4.1	1.6	4.7	2.0	5.7	2.6	7.4
	Spray Angle	77°	—	82°	—	84°	—	86°	—	86°	—
	Max. Throw (m)	1.2	10	1.4	11	1.5	12	1.7	12	1.8	12

## 5500

Knurled body of tip rotates through a half turn to provide spray selection from wide angle, finely atomized cone spray to a straight stream spray. Tip settings "A" and "B" represent two extreme points of rotation in tip adjustment. Other sizes available.



## 5500-PP

The 5500 adjustable ConeJet® tip is also available in a polypropylene version. The polypropylene tip has the same performance characteristics as the brass tip and provides excellent chemical resistance. This tip's light weight makes it well-suited for use on handheld and backpack type sprayers.

O-Ring: EPDM is standard, FKM is optional.

Tip Setting "A"  
Cone Spray Pattern

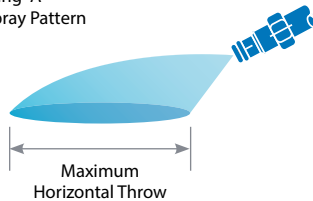

Tip Setting "B"  
Straight Stream Spray Pattern

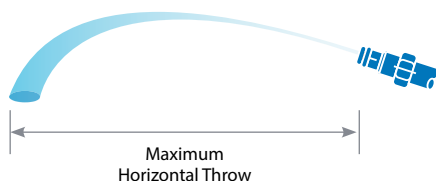

ADJUSTABLE CONEJET TIP NUMBER	PERFORMANCE	LIQUID PRESSURE IN BAR											
		1.5 bar		2 bar		3 bar		4 bar		7 bar		10 bar	
		SETTING		SETTING		SETTING		SETTING		SETTING		SETTING	
		A	B	A	B	A	B	A	B	A	B	A	B
5500-X1	Capacity (l/min)	—	0.19	0.057	0.23	0.064	0.26	0.076	0.33	0.095	0.42	0.11	0.53
	Spray Angle	—	—	38°	—	54°	—	76°	—	80°	—	83°	—
	Max. Throw (m)	—	7.4	0.30	8.4	0.46	9.5	.46	9.1	.46	7.7	0.46	5.5
5500-X2	Capacity (l/min)	0.09	0.34	0.11	0.42	0.12	0.49	0.15	0.61	0.19	0.76	0.22	0.95
	Spray Angle	40°	—	60°	—	68°	—	75°	—	80°	—	83°	—
	Max. Throw (m)	0.46	8.9	0.46	9.8	0.61	10.2	0.61	10.0	0.61	8.7	0.61	6.4
5500-X3	Capacity (l/min)	0.14	0.49	0.17	0.64	0.19	0.72	0.22	0.87	0.28	1.14	0.33	1.40
	Spray Angle	57°	—	68°	—	72°	—	76°	—	80°	—	82°	—
	Max. Throw (m)	0.61	9.5	0.61	10.4	0.61	10.8	0.61	10.4	0.91	9.2	0.91	7.0
5500-PPB-X3	Capacity (l/min)	0.61	9.4	0.61	10.1	0.61	10.1	0.61	9.7	0.91	8.8	0.91	7.7
	Spray Angle	61°	—	70°	—	73°	—	77°	—	80°	—	81°	—
	Max. Throw (m)	0.76	10.0	0.76	10.9	0.91	11.1	0.91	10.7	0.91	9.5	0.91	7.6
5500-X4	Capacity (l/min)	0.19	0.68	0.22	0.83	0.25	0.95	0.30	1.17	0.38	1.51	0.45	1.85
	Spray Angle	61°	—	70°	—	73°	—	77°	—	80°	—	81°	—
	Max. Throw (m)	0.76	10.0	0.76	10.9	0.91	11.1	0.91	10.7	0.91	9.5	0.91	7.6
5500-X5	Capacity (l/min)	0.23	0.79	0.29	0.98	0.31	1.14	0.38	1.40	0.49	1.82	0.57	2.20
	Spray Angle	61°	—	70°	—	74°	—	77°	—	80°	—	81°	—
	Max. Throw (m)	0.76	10.3	0.76	11.1	0.91	11.3	0.91	10.9	0.91	9.7	0.91	8.0
5500-PPB-X5	Capacity (l/min)	0.76	9.9	0.76	10.2	0.91	10.2	0.91	9.8	0.91	9.0	0.91	8.0
	Spray Angle	65°	—	71°	—	74°	—	77°	—	80°	—	80°	—
	Max. Throw (m)	0.76	10.6	0.91	11.4	0.91	11.7	1.1	11.1	1.1	10.0	1.1	8.4
5500-X6	Capacity (l/min)	0.28	0.98	0.33	1.21	0.38	1.40	0.45	1.70	0.57	2.20	0.72	2.69
	Spray Angle	65°	—	71°	—	74°	—	77°	—	80°	—	80°	—
	Max. Throw (m)	0.76	10.2	0.91	10.4	0.91	10.4	1.1	10.0	1.1	9.2	1.1	8.3
5500-PPB-X6	Capacity (l/min)	0.37	1.25	0.45	1.51	0.49	1.78	0.61	2.16	0.79	2.80	0.95	3.41
	Spray Angle	66°	—	71°	—	74°	—	77°	—	80°	—	80°	—
	Max. Throw (m)	0.91	10.9	0.91	11.9	0.91	12.1	0.91	11.5	1.2	10.5	1.2	9.1
5500-X8	Capacity (l/min)	0.45	1.59	0.57	1.97	0.64	2.27	0.79	2.76	0.98	3.56	1.17	4.54
	Spray Angle	68°	—	72°	—	75°	—	78°	—	80°	—	80°	—
	Max. Throw (m)	0.91	11.2	1.1	12.1	1.1	12.3	1.2	11.9	1.2	10.9	1.2	9.7
5500-PPB-X8	Capacity (l/min)	0.57	1.85	0.68	2.27	0.76	2.61	0.91	3.18	1.17	4.16	1.44	4.92
	Spray Angle	69°	—	73°	—	76°	—	78°	—	80°	—	80°	—
	Max. Throw (m)	1.1	11.5	1.2	12.4	1.2	12.7	1.2	12.3	1.2	11.4	1.2	10.2
5500-PPB-X12	Capacity (l/min)	1.1	10.9	1.2	10.9	1.2	10.9	1.2	10.7	1.2	10.1	1.2	9.0
	Spray Angle	70°	—	74°	—	76°	—	78°	—	80°	—	80°	—
	Max. Throw (m)	1.1	11.6	1.2	12.6	1.2	13.0	1.2	12.6	1.4	11.9	1.4	10.9
5500-X14	Capacity (l/min)	0.64	2.08	0.76	2.54	0.87	2.95	1.10	3.60	1.40	4.54	1.70	5.68
	Spray Angle	70°	—	74°	—	76°	—	78°	—	80°	—	80°	—
	Max. Throw (m)	1.1	11.6	1.2	12.6	1.2	13.0	1.2	12.6	1.4	11.9	1.4	10.9
5500-X18	Capacity (l/min)	0.79	2.61	0.98	3.18	1.14	3.67	1.40	4.54	1.78	5.68	2.20	7.19
	Spray Angle	71°	—	75°	—	77°	—	78°	—	80°	—	79°	—
	Max. Throw (m)	1.2	11.6	1.2	12.8	1.2	13.3	1.2	13.0	1.5	12.3	1.5	11.4
5500-PPB-X18	Capacity (l/min)	1.2	11.0	1.2	11.1	1.2	11.1	1.2	11.0	1.5	10.4	1.5	9.5
	Spray Angle	71°	—	75°	—	77°	—	79°	—	80°	—	78°	—
	Max. Throw (m)	1.2	11.7	1.40	13.0	1.5	13.6	1.5	13.2	1.5	12.4	1.5	11.3
5500-X22	Capacity (l/min)	0.98	3.14	1.21	3.79	1.40	4.54	1.70	5.30	2.20	7.19	2.65	8.71
	Spray Angle	71°	—	75°	—	78°	—	79°	—	80°	—	78°	—
	Max. Throw (m)	1.2	11.7	1.40	13.0	1.5	13.6	1.5	13.2	1.5	12.4	1.5	11.3
5500-PPB-X22	Capacity (l/min)	1.17	3.71	1.40	4.54	1.63	5.30	2.01	6.43	2.57	8.33	3.14	10.22
	Spray Angle	72°	—	76°	—	78°	—	79°	—	80°	—	78°	—
	Max. Throw (m)	1.4	11.6	1.5	13.1	1.5	13.7	1.7	13.3	1.7	12.6	1.7	11.2

Above data is based on spraying water from a height of about 76.2 cm with tip tilted about as shown at left for each setting.

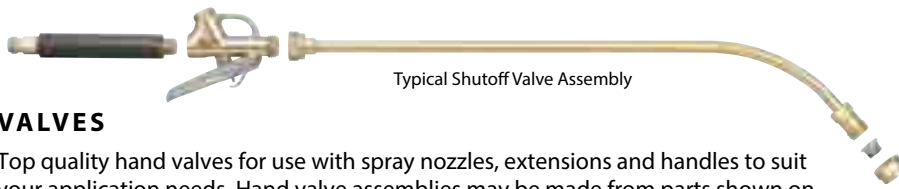

Typical Shutoff Valve Assembly

## VALVES

Top quality hand valves for use with spray nozzles, extensions and handles to suit your application needs. Hand valve assemblies may be made from parts shown on this page. The "typical assembly" shown above includes 4727 handle, 4688 valve, 6671-18 curved extension with swivel body, TeeJet cap and flat spray tip.

### AA31

For pressures up to 35 bar. Comfortable palm fitting gun. For use with any TeeJet spray tip. 1/4" NPS (M) inlet connection.



Forged brass body and nickel-plated steel trigger. PTFE valve seat and packing, stainless steel valve stem. Also supplied as 31-1/4F with 1/4" NPT (F) inlet connection.

### AA36 TRIGGER VALVE WITH TRIGGER LOCK

Choice of 1/4" NPT (F) inlet and outlet, or 3/8" NPT (F) inlet and outlet. Max pressure of 10 bar. Brass or stainless steel material.



### 6104 TRIGGER VALVE WITH TRIGGER LOCK

Same as 4688 except with 1/4" NPT (F) inlet and outlet connections. Brass material.



### 6466 TRIGGER VALVE

Same as 4688, less trigger lock, with extra long trigger. Brass material.



### 4688 TRIGGER VALVE WITH TRIGGER LOCK

Max flow rate 7.6 l/min, max pressure of 17 bar. 1/4" NPT (F) inlet connection, 1/6"-16 (M) outlet connection. Brass material.



### 6590 TRIGGER VALVE

Same as 6104, less trigger lock, with extra long trigger. Brass material.



### 13212 ADAPTER

3/8" NPT (M) outlet, 3/4" garden hose thread inlet for use with 3/8" 36 valve. Brass material.



## VALVE HANDLES

(Choice of valve handles for above valves.)

Outlet connections are 1/4" NPT (M) to fit 1/4" NPT (F) inlets of all valves shown.



### (B)4727 SURE GRIP HANDLE

Brass, rubber-covered, 1/4" NPS (M) inlet connection.



### 4754 SURE GRIP HANDLE

Brass, rubber-covered, 3/4" garden hose thread (F) inlet connection.

## EXTENSIONS

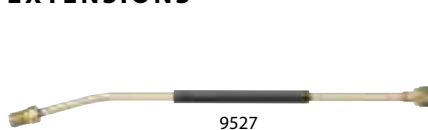

9527



4673

7715

### HIGH-PRESSURE CURVED EXTENSIONS

9527 for pressures to 70 bar. Fits models 23H and 31 GunJet spray guns.

### STRAIGHT & CURVED EXTENSIONS

4673 and 6671 are for pressures to 9 bar. 7715 is for pressures to 17 bar. Fits models 23L and 31 GunJet spray guns and trigger valves. CP4743-TEF inlet gasket for use with 4673, 6671, and 7715 extensions.

### TRIGGERJET® EXTENSION

22665-PP is for use with 22650-PP TriggerJet spray gun. Maximum pressure rating of 10 bar. Available in 38 and 61 cm lengths.

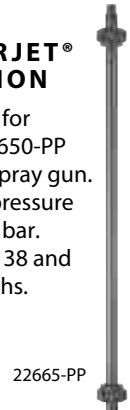

22665-PP

EXTENSION TYPE & NUMBER	EXTENSION LENGTH (mm)
9527-8	203
9527-18	457
9527-24	610
9527-36	914
9527-48	1,219

STRAIGHT WITH FIXED BODY	CURVED WITH SWIVEL BODY	CURVED WITH FIXED BODY	EXTENSION LENGTH (mm)
7715-8	4673-8	6671-8	203
7715-18	4673-18	6671-18	457
7715-24	4673-24	6671-24	610
7715-30	4673-30	6671-30	762
7715-36	4673-36	6671-36	914
7715-48	4673-48	6671-48	1,219



# UNIVERSAL APPLICATION RATE CHART FOR 25 CM TIP SPACING

TIP CAPACITY	LIQUID PRESSURE IN bar	CAPACITY ONE NOZZLE IN l/min	l/ha – 25 cm NOZZLE SPACING											
			4 km/h	6 km/h	8 km/h	10 km/h	12 km/h	14 km/h	16 km/h	18 km/h	20 km/h	25 km/h	30 km/h	35 km/h
01	1.0	0.23	138	92.0	69.0	55.2	46.0	39.4	34.5	30.7	27.6	22.1	18.4	15.8
	1.5	0.28	168	112	84.0	67.2	56.0	48.0	42.0	37.3	33.6	26.9	22.4	19.2
	2.0	0.32	192	128	96.0	76.8	64.0	54.9	48.0	42.7	38.4	30.7	25.6	21.9
	3.0	0.39	234	156	117	93.6	78.0	66.9	58.5	52.0	46.8	37.4	31.2	26.7
	4.0	0.45	270	180	135	108	90.0	77.1	67.5	60.0	54.0	43.2	36.0	30.9
	5.0	0.50	300	200	150	120	100	85.7	75.0	66.7	60.0	48.0	40.0	34.3
	6.0	0.51	330	220	165	132	110	94.3	82.5	73.3	66.0	52.8	44.0	37.2
	7.0	0.60	360	240	180	144	120	103	90.0	80.0	72.0	57.6	48.0	41.1
015	1.0	0.34	204	136	102	81.6	68.0	58.3	51.0	45.3	40.8	32.6	27.2	23.3
	1.5	0.42	252	168	126	101	84.0	72.0	63.0	56.0	50.4	40.3	33.6	28.8
	2.0	0.48	288	192	144	115	96.0	82.3	72.0	64.0	57.6	46.1	38.4	32.9
	3.0	0.59	354	236	177	142	118	101	88.5	78.7	70.8	56.6	47.2	40.5
	4.0	0.68	408	272	204	163	136	117	102	90.7	81.6	65.3	54.4	46.6
	5.0	0.76	456	304	228	182	152	130	114	101	91.2	73.0	60.8	52.1
	6.0	0.83	498	332	249	199	166	142	125	111	99.6	79.7	66.4	56.9
	7.0	0.90	540	360	270	216	180	154	135	120	108	86.4	72.0	61.7
02	1.0	0.46	276	184	138	110	92.0	78.9	69.0	61.3	55.2	44.2	36.8	31.5
	1.5	0.56	336	224	168	134	112	96.0	84.0	74.7	67.2	53.8	44.8	38.4
	2.0	0.65	390	260	195	156	130	111	97.5	86.7	78.0	62.4	52.0	44.6
	3.0	0.79	474	316	237	190	158	135	119	105	94.8	75.8	63.2	54.2
	4.0	0.91	546	364	273	218	182	156	137	121	109	87.4	72.8	62.4
	5.0	1.02	612	408	306	245	204	175	153	136	122	97.9	81.6	69.9
	6.0	1.12	672	448	336	269	224	192	168	149	134	108	89.6	76.8
	7.0	1.21	726	484	363	290	242	207	182	161	145	116	96.8	83.0
025	1.0	0.57	342	228	171	137	114	97.7	85.5	76.0	68.4	54.7	45.6	39.1
	1.5	0.70	420	280	210	168	140	120	105	93.3	84.0	67.2	56.0	48.0
	2.0	0.81	486	324	243	194	162	139	122	108	97.2	77.8	64.8	55.5
	3.0	0.99	594	396	297	238	198	170	149	132	119	95.0	79.2	67.9
	4.0	1.14	684	456	342	274	228	195	171	152	137	109	91.2	78.2
	5.0	1.28	768	512	384	307	256	219	192	171	154	123	102	87.8
	6.0	1.40	840	560	420	336	280	240	210	187	168	134	112	96.0
	7.0	1.51	906	604	453	362	302	259	227	201	181	145	121	104
03	1.0	0.68	408	272	204	163	136	117	102	90.7	81.6	65.3	54.4	46.6
	1.5	0.83	498	332	249	199	166	142	125	111	99.6	79.7	66.4	56.9
	2.0	0.96	576	384	288	230	192	165	144	128	115	92.2	76.8	65.8
	3.0	1.18	708	472	354	283	236	202	177	157	142	113	94.4	80.9
	4.0	1.36	816	544	408	326	272	233	204	181	163	131	109	93.3
	5.0	1.52	912	608	456	365	304	261	228	203	182	146	122	104
	6.0	1.67	1002	668	501	401	334	286	251	223	200	160	134	115
	7.0	1.80	1080	720	540	432	360	309	270	240	216	173	144	123
035	1.0	0.80	480	320	240	192	160	137	120	107	96.0	76.8	64.0	54.9
	1.5	0.98	588	392	294	235	196	168	147	131	118	94.1	78.4	67.2
	2.0	1.13	678	452	339	271	226	194	170	151	136	108	90.4	77.5
	3.0	1.38	828	552	414	331	276	237	207	184	166	132	110	94.6
	4.0	1.59	954	636	477	382	318	273	239	212	191	153	127	109
	5.0	1.78	1068	712	534	427	356	305	267	237	214	171	142	122
	6.0	1.95	1170	780	585	468	390	334	293	260	234	187	156	134
	7.0	2.11	1266	844	633	506	422	362	317	281	253	203	169	145
04	1.0	0.91	546	364	273	218	182	156	137	121	109	87.4	72.8	62.4
	1.5	1.12	672	448	336	269	224	192	168	149	134	108	89.6	76.8
	2.0	1.29	774	516	387	310	258	221	194	172	155	124	103	88.5
	3.0	1.58	948	632	474	379	316	271	237	211	190	152	126	108
	4.0	1.82	1092	728	546	437	364	312	273	243	218	175	146	125
	5.0	2.04	1224	816	612	490	408	350	306	272	245	196	163	140
	6.0	2.23	1338	892	669	535	446	382	335	297	268	214	178	153
	7.0	2.41	1446	964	723	578	482	413	362	321	289	231	193	165
05	1.0	1.14	684	456	342	274	228	195	171	152	137	109	91.2	78.2
	1.5	1.39	834	556	417	334	278	238	209	185	167	133	111	95.3
	2.0	1.61	966	644	483	386	322	276	242	215	193	155	129	110
	3.0	1.97	1182	788	591	473	394	338	296	263	236	189	158	135
	4.0	2.27	1362	908	681	545	454	389	341	303	272	218	182	156
	5.0	2.54	1524	1016	762	610	508	435	381	339	305	244	203	174
	6.0	2.79	1674	1116	837	670	558	478	419	372	335	268	223	191
	7.0	3.01	1806	1204	903	722	602	516	452	401	361	289	241	206
06	1.0	1.37	922	618	462	374	325	286	256	226	196	156	132	110
	1.5	1.68	1098	732	544	443	366	316	288	252	224	181	154	131
	2.0	1.94	1164	776	582	466	388	333	291	259	233	186	155	133
	3.0	2.37	1422	948	711	569	474	406	356	316	284	228	190	163
	4.0	2.74	1644	1096	822	658	548	470	411	365	329	263	219	188
	5.0	3.06	1836	1224	918	734	612	525	459	408	367	294	245	210
	6.0	3.35	2010	1340	1005	804	670	574	503	447	402	322	268	230
	7.0	3.62	2172	1448	1086	869	724	621	543	483	434	348	290	248
08	1.0	1.82	1092	728	546	437	364	312	273	243	218	175	146	125
	1.5	2.23	1338	892	669	535	446	382	335	297	268	214	178	153
	2.0	2.58	1548	1032	774	619	516	442	387	344	310	248	206	177
	3.0	3.16	1896	1264	948	758	632	542	474	421	379	303	253	217
	4.0	3.65	2190	1460	1095	876	730	626	548	487	438	350	292	250
	5.0	4.08	2448	1632	1224	979	816	699	612	544	490	392	326	280
	6.0	4.47	2682	1788	1341	1073	894	766	671	596	536	429	358	307
	7.0	4.83	2898	1932	1449	1159	966	828	725	644	580	464	386	331
10	1.0	2.28	1368	912	684	547	456	391	342	304	274	219	182	156
	1.5	2.79	1674	1116	837	670	558	478	419	372	335	268	223	191
	2.0	3.23	1938	1292	969	775	646	554	485	431	388	310	258	221
	3.0	3.95	2370	1580	1185	948	790	677	593	527	474	379	316	271
	4.0	4.56	2736	1824	1368	1094	912	782	684	608	547	438	365	313
	5.0	5.10	3060	2040	1530	1224	1020	874	765	680	612	490	408	350
	6.0	5.59	3354	2236	1677	1342	1118	958	839	745	671	537	447	383
	7.0	6.03	3618	2412	1809	1447	1206	1034	905	804	724	579	482	413
12	1.0	2.73	1638	1092	819	655	546	468	410	364	328	262	218	187
	1.5	3.34	2004	1336	1002	802	668	573	501	445	401	321	267	229
	2.0	3.86	2316	1544	1158	926	772	662	579	515	463	371	309	265
	3.0	4.73	2838	1892	1419	1135	946	811	710	631	568	454	378	324
	4.0	5.46	3276	2184	1638	1310	1092	936	819	728	655	524	439	374
	5.0	6.11	3666	2444	1837	1466	1222	1047	917	815	733	587	489	419
	6.0	6.69	4014	2676	2007	1606	1338	1147	1004	892	803	642	535	459
	7.0	7.23	4338	2892	2169	1735	1446	1259	1085	964	868	694	578	496
15	1.0	3.42	2052	1368	1026	821	684	586	513	456	410	328	274	235
	1.5	4.19	2514	1676	1257	1006	838	718	629	559	503	402	335	287
	2.0	4.83												





# UNIVERSAL APPLICATION RATE CHART FOR 35 CM TIP SPACING

TIP CAPACITY	LIQUID PRESSURE IN bar	CAPACITY ONE NOZZLE IN /min	l/ha – 35 cm NOZZLE SPACING											
			4 km/h	6 km/h	8 km/h	10 km/h	12 km/h	14 km/h	16 km/h	18 km/h	20 km/h	25 km/h	30 km/h	35 km/h
01	1.0	0.23	98.6	65.7	49.3	39.4	32.9	28.2	24.6	21.9	19.7	15.8	13.1	11.3
	1.5	0.28	120	80.0	60.0	48.0	40.0	34.3	30.0	26.7	24.0	19.2	16.0	13.7
	2.0	0.32	137	91.4	68.6	54.9	45.7	39.2	34.3	30.5	27.4	21.9	18.3	15.7
	3.0	0.39	167	111	83.6	66.9	55.7	47.8	41.8	37.1	33.4	26.7	22.3	19.1
	4.0	0.45	193	129	96.4	77.1	64.3	55.1	48.2	42.9	38.6	30.9	25.7	22.0
	5.0	0.50	214	143	107	85.7	71.4	61.2	53.6	47.6	42.9	34.3	28.6	24.5
	7.0	0.60	257	171	129	103	85.7	73.5	64.3	57.1	51.4	41.1	34.3	29.4
015	1.0	0.34	146	97.1	72.9	58.3	48.6	41.6	36.4	32.4	29.1	23.3	19.4	16.7
	1.5	0.42	180	120	90.0	72.0	60.0	51.4	45.0	40.0	36.0	28.8	24.0	20.6
	2.0	0.48	206	137	103	82.3	68.6	58.8	51.4	45.7	41.1	32.9	27.4	23.5
	3.0	0.59	253	169	126	101	84.3	72.2	63.2	56.2	50.6	40.5	33.7	28.9
	4.0	0.68	291	194	146	117	97.1	83.3	72.9	64.8	58.3	46.6	38.9	33.3
	5.0	0.76	326	217	163	130	109	93.1	81.4	72.4	65.1	52.1	43.4	37.2
	7.0	0.90	386	257	193	154	129	110	96.4	85.7	77.1	61.7	51.4	44.1
02	1.0	0.46	197	131	98.6	78.9	65.7	56.3	49.3	43.8	39.4	31.5	26.3	22.5
	1.5	0.56	240	160	120	96.0	80.0	68.6	60.0	53.3	48.0	38.4	32.0	27.4
	2.0	0.65	279	186	139	111	92.9	79.6	69.6	61.9	55.7	44.6	37.1	31.8
	3.0	0.79	339	226	165	132	113	96.7	84.6	75.2	67.7	54.2	45.1	38.7
	4.0	0.91	390	260	195	156	130	111	97.5	86.7	78.0	62.4	52.0	44.6
	5.0	1.02	437	291	219	175	146	125	109	97.1	87.4	69.9	58.3	50.0
	7.0	1.12	480	320	240	192	160	137	120	107	96.0	76.8	64.0	54.9
025	1.0	0.57	244	163	122	97.7	81.4	69.8	61.1	54.3	48.9	39.1	32.6	27.9
	1.5	0.70	300	200	150	120	100	85.7	75.0	66.7	60.0	48.0	40.0	34.3
	2.0	0.81	347	231	174	139	116	99.2	86.8	77.1	69.4	55.5	46.3	39.7
	3.0	0.99	424	283	212	170	141	121	106	94.3	84.9	67.9	56.6	48.5
	4.0	1.14	489	326	244	195	163	140	122	109	97.7	78.2	65.1	55.8
	5.0	1.28	549	366	274	219	183	157	137	122	110	87.8	73.1	62.7
	7.0	1.40	600	400	300	240	200	171	150	133	120	96.0	80.0	68.6
03	1.0	0.68	291	194	146	117	97.1	83.3	72.9	64.8	58.3	46.6	38.9	33.3
	1.5	0.83	356	237	178	142	119	102	88.9	79.0	71.1	56.9	47.4	40.7
	2.0	0.96	411	274	206	165	137	118	103	91.4	82.3	65.8	54.9	47.0
	3.0	1.18	506	337	253	202	169	144	126	112	101	80.9	67.4	57.8
	4.0	1.36	583	389	291	233	194	167	146	130	117	93.3	77.7	66.6
	5.0	1.52	651	434	326	261	217	186	163	145	130	104	86.9	74.4
	7.0	1.67	716	477	358	286	239	204	179	159	143	115	95.4	81.8
035	1.0	0.80	343	229	171	137	114	98.0	85.7	76.2	68.6	54.9	45.7	39.2
	1.5	0.98	420	280	210	168	140	120	105	93.3	84.0	67.2	56.0	48.0
	2.0	1.13	484	323	242	194	161	138	121	108	96.9	77.5	64.6	55.3
	3.0	1.38	591	394	296	237	197	169	148	131	118	94.6	78.9	67.6
	4.0	1.59	681	454	341	273	227	195	170	151	136	109	90.9	77.9
	5.0	1.78	763	509	381	305	254	218	191	170	153	122	102	87.2
	7.0	1.95	836	557	418	334	279	239	209	186	167	134	111	95.5
04	1.0	0.91	390	260	195	156	130	111	97.5	86.7	78.0	62.4	52.0	44.6
	1.5	1.12	480	320	240	192	160	137	120	107	96.0	76.8	64.0	54.9
	2.0	1.29	553	369	276	221	184	158	138	123	111	88.5	73.7	63.2
	3.0	1.58	677	451	339	271	226	193	169	150	135	108	90.3	77.4
	4.0	1.82	780	520	390	312	260	223	195	173	156	125	104	89.1
	5.0	2.04	874	583	437	350	291	250	219	194	175	140	117	99.9
	7.0	2.23	956	637	478	382	319	273	239	212	191	153	127	109
05	1.0	1.14	489	326	244	195	163	140	122	109	97.7	78.2	65.1	55.8
	1.5	1.39	596	397	298	238	199	170	149	132	119	95.3	79.4	68.1
	2.0	1.61	690	460	345	276	230	197	173	153	138	110	92.0	78.9
	3.0	1.97	844	563	422	338	281	241	211	188	169	135	113	96.5
	4.0	2.27	973	649	486	389	324	278	243	216	195	156	130	111
	5.0	2.54	1089	726	544	435	363	311	272	242	218	174	145	124
	7.0	2.79	1196	797	598	478	399	347	299	266	239	191	159	137
06	1.0	1.37	1290	860	645	516	430	369	323	287	258	206	172	147
	1.5	1.68	1587	1039	784	625	516	430	369	323	287	228	199	173
	2.0	1.94	1831	1220	914	725	596	497	417	350	314	249	211	187
	3.0	2.37	2270	1514	1124	896	725	600	500	426	377	303	255	219
	4.0	2.74	2644	1744	1304	1034	854	700	574	484	426	347	291	250
	5.0	3.06	3111	2044	1514	1204	1004	834	694	584	504	404	344	294
	7.0	3.35	3436	2274	1714	1374	1154	954	794	664	564	444	374	324
08	1.0	1.82	780	520	390	312	260	223	195	173	156	125	104	89.1
	1.5	2.23	956	637	478	382	319	273	239	212	191	153	127	109
	2.0	2.58	1106	737	553	442	369	316	276	246	221	177	147	126
	3.0	3.16	1354	903	677	542	451	387	339	301	271	217	181	155
	4.0	3.65	1564	1043	782	626	521	447	391	348	313	250	209	179
	5.0	4.08	1749	1166	874	699	583	500	437	389	350	280	230	200
	7.0	4.47	1916	1277	958	766	639	547	479	426	383	307	255	219
10	1.0	2.28	977	651	489	391	326	279	244	217	195	156	130	112
	1.5	2.79	1196	797	598	478	399	342	299	266	239	191	159	137
	2.0	3.23	1384	923	692	554	461	396	346	308	277	221	185	158
	3.0	3.95	1693	1129	846	677	564	484	423	376	339	271	226	193
	4.0	4.56	1954	1303	977	782	651	558	489	434	391	313	261	223
	5.0	5.10	2186	1457	1093	874	729	624	546	486	437	350	291	250
	7.0	5.59	2396	1597	1198	958	799	684	599	532	479	383	319	274
12	1.0	2.73	1170	780	585	468	390	334	293	260	234	187	156	134
	1.5	3.34	1431	954	716	573	477	409	358	318	286	229	191	164
	2.0	3.86	1654	1103	827	662	551	473	414	368	331	265	221	189
	3.0	4.73	2027	1351	1014	811	676	570	507	450	405	324	270	232
	4.0	5.46	2340	1560	1170	936	780	669	585	520	468	374	312	267
	5.0	6.11	2619	1746	1309	1047	873	748	655	582	524	419	349	299
	7.0	7.23	3099	2066	1549	1239	1033	885	775	689	620	496	413	354
15	1.0	3.42	1466	977	733	586	489	419	366	326	293	235	195	168
	1.5	4.19	1796	1197	898	718	599	513	449	399	359	287	239	205
	2.0	4.83	2070	1380	1035	828	690	591	518	460	414	331	276	237
	3.0	5.92	2537	1691	1269	1015	846	725	634	564	507	406	338	290
	4.0	6.84	2931	1954	1466	1173	977	838	733	651	586	469	391	335
	5.0	7.64	3274	2183	1637	1310	1091	936	819	728	655	524	437	374
	7.0	8.37	3587	2391	1794	1435	1196	1025	897	797	717	574	478	410
20	1.0	4.56	1954	1303	977	782	651	558	489	434	391	313	261	223
	1.5	5.58	2391	1594	1196	957	797	683	598	531	478	383	319	273
	2.0	6.44	2760	1840	1380	1104	920	789	690	613	552	442	368	315
	3.0	7.89	3381	2254	1691	1353	1127	966	845	751	676	541	451	386
	4.0	9.11	3904	2603	1952	1562	1301	1116	976	868	781	625	521	446
	5.0	10.19	4367	2911	2184	1747	1456	1248	1092	970	873	699	582	499
	7.0	11.16	4783	3189	23									



# UNIVERSAL APPLICATION RATE CHART FOR 50 CM TIP SPACING

TIP CAPACITY	LIQUID PRESSURE IN bar	CAPACITY 1 NOZZLE IN l/min	l/ha – 50 cm NOZZLE SPACING											
			4 km/h	6 km/h	8 km/h	10 km/h	12 km/h	14 km/h	16 km/h	18 km/h	20 km/h	25 km/h	30 km/h	35 km/h
01	1.0	0.23	69.0	46.0	34.5	27.6	23.0	19.7	17.3	15.3	13.8	11.0	9.2	7.9
	1.5	0.28	84.0	56.0	42.0	33.6	28.0	24.0	21.0	18.7	16.8	13.4	11.2	9.6
	2.0	0.32	96.0	64.0	48.0	38.4	32.0	27.4	24.0	21.3	19.2	15.4	12.8	11.0
	3.0	0.39	117	78.0	58.5	46.8	39.0	33.4	29.3	26.0	23.4	18.7	15.6	13.4
	4.0	0.45	135	90.0	67.5	54.0	45.0	38.6	33.8	30.0	27.0	21.6	18.0	15.4
	5.0	0.50	150	100	75.0	60.0	50.0	42.9	37.5	33.0	30.0	24.0	20.0	17.1
	7.0	0.60	180	120	90.0	72.0	60.0	51.4	45.0	40.0	36.0	28.8	24.0	20.6
015	1.0	0.34	102	68.0	51.0	40.8	34.0	29.1	25.5	22.7	20.4	16.3	13.6	11.7
	1.5	0.42	126	84.0	63.0	50.4	42.0	36.0	31.5	28.0	25.2	20.2	16.8	14.4
	2.0	0.48	144	96.0	72.0	57.6	48.0	41.1	36.0	32.0	28.8	23.0	19.2	16.5
	3.0	0.59	177	118	88.5	70.8	59.0	50.6	44.3	39.3	35.4	28.3	23.6	20.2
	4.0	0.68	204	136	102	81.6	68.0	58.3	51.0	45.3	40.8	32.6	27.2	23.3
	5.0	0.76	228	152	114	91.2	76.0	65.1	57.0	50.7	45.6	36.5	30.4	26.1
	7.0	0.90	270	180	135	108	90.0	77.1	67.5	60.0	54.0	43.2	36.0	30.9
02	1.0	0.46	138	92.0	69.0	55.2	46.0	39.4	34.5	30.7	27.6	22.1	18.4	15.8
	1.5	0.56	168	112	84.0	67.2	56.0	48.0	42.0	37.3	33.6	26.9	22.4	19.2
	2.0	0.65	195	130	97.5	78.0	65.0	55.7	48.8	43.3	39.0	31.2	26.0	22.3
	3.0	0.79	237	158	119	95.4	79.0	67.7	59.3	52.7	47.4	37.9	31.6	27.1
	4.0	0.91	273	182	137	109	91.0	78.0	68.3	60.7	54.6	43.7	36.4	31.2
	5.0	1.02	306	204	153	122	102	87.4	76.5	68.0	61.2	49.0	40.8	35.0
	7.0	1.12	336	224	168	134	112	96.0	84.0	74.7	67.2	53.8	44.8	38.4
025	1.0	0.57	171	114	85.5	68.4	57.0	48.9	42.8	38.0	34.2	27.4	22.8	19.5
	1.5	0.70	210	140	105	84.0	70.0	60.0	52.5	46.7	42.0	33.6	28.0	24.0
	2.0	0.81	243	162	122	97.2	81.0	69.4	60.8	54.0	48.6	38.9	32.4	27.8
	3.0	0.99	297	198	149	119	99.0	84.9	74.3	66.0	59.4	47.5	39.6	33.9
	4.0	1.14	342	228	171	137	114	97.7	85.5	76.0	68.4	54.7	45.6	39.1
	5.0	1.28	384	256	192	154	128	110	96.0	85.3	76.8	61.4	51.2	43.9
	7.0	1.40	420	280	210	168	140	120	105	93.3	84.0	67.2	56.0	48.0
03	1.0	0.68	204	136	102	81.6	68.0	58.3	51.0	45.3	40.8	32.6	27.2	23.3
	1.5	0.83	249	166	125	99.6	83.0	71.1	62.3	55.3	49.8	39.8	33.2	28.5
	2.0	0.96	288	192	144	115	96.0	82.3	72.0	64.0	57.6	46.1	38.4	32.9
	3.0	1.18	354	236	177	142	118	101	88.5	78.7	70.8	56.6	47.2	40.5
	4.0	1.36	408	272	204	163	136	117	102	90.7	81.6	65.3	54.4	46.6
	5.0	1.52	456	304	228	182	152	130	114	101	91.2	73.0	60.8	52.1
	7.0	1.67	501	334	251	200	167	143	125	111	100	80.2	66.8	57.3
035	1.0	0.80	240	160	120	96.0	80.0	68.6	60.0	53.3	48.0	38.4	32.0	27.4
	1.5	0.98	294	196	147	118	98.0	84.0	73.5	65.3	58.8	47.0	39.2	33.6
	2.0	1.13	339	226	170	136	113	96.9	84.8	75.3	67.8	54.2	45.2	38.7
	3.0	1.38	414	276	207	166	138	118	104	92.0	82.8	66.2	55.2	47.3
	4.0	1.59	477	318	239	191	159	136	119	106	95.4	76.3	63.6	54.5
	5.0	1.78	534	356	267	214	178	153	134	119	107	85.4	71.2	61.0
	7.0	1.95	585	390	293	234	195	167	146	130	117	93.6	78.0	66.9
04	1.0	0.91	273	182	137	109	91.0	78.0	68.3	60.7	54.6	43.7	36.4	31.2
	1.5	1.12	336	224	168	134	112	96.0	84.0	74.7	67.2	53.8	44.8	38.4
	2.0	1.29	387	258	194	155	129	111	96.8	86.0	77.4	61.9	51.6	44.2
	3.0	1.58	474	316	237	190	158	135	119	105	94.8	75.8	63.2	54.2
	4.0	1.82	546	364	273	218	182	156	137	121	109	87.4	72.8	62.4
	5.0	2.04	612	408	306	245	204	175	153	136	122	97.9	81.6	69.9
	7.0	2.23	669	446	335	268	223	191	167	149	134	107	89.2	76.5
05	1.0	1.14	342	228	171	137	114	97.7	85.5	76.0	68.4	54.7	45.6	39.1
	1.5	1.39	417	278	209	167	139	119	104	92.7	83.4	66.7	55.6	47.7
	2.0	1.61	483	322	242	193	161	138	121	107	96.6	77.3	64.4	55.2
	3.0	1.97	591	394	296	236	197	169	148	131	118	94.6	78.8	67.5
	4.0	2.27	681	454	341	272	227	195	170	151	136	109	90.8	77.8
	5.0	2.54	762	508	381	305	254	218	191	169	152	122	102	87.1
	7.0	2.79	837	558	419	335	279	239	209	186	167	134	112	95.7
06	1.0	1.37	411	274	206	164	137	117	103	91.3	82.2	65.8	54.8	47.0
	1.5	1.68	504	336	252	202	168	144	126	112	101	80.6	67.2	57.6
	2.0	1.94	582	388	291	233	194	166	146	129	116	93.1	77.6	66.5
	3.0	2.37	711	474	356	284	237	203	178	158	142	114	94.8	81.3
	4.0	2.74	822	548	411	329	274	235	206	183	164	132	110	93.9
	5.0	3.06	918	612	459	367	306	262	230	204	184	147	122	105
	7.0	3.35	1005	670	503	402	335	287	251	223	201	161	134	115
08	1.0	1.82	546	364	273	218	182	156	137	121	109	87.4	72.8	62.4
	1.5	2.23	669	446	335	268	223	191	167	149	134	107	89.2	76.5
	2.0	2.58	774	516	387	310	258	221	194	172	155	124	103	88.5
	3.0	3.16	948	632	474	379	316	271	237	211	190	152	126	108
	4.0	3.65	1095	730	548	438	365	313	274	243	219	175	146	125
	5.0	4.08	1224	816	612	490	408	350	306	272	245	196	163	140
	7.0	4.47	1341	894	671	536	447	383	335	298	268	215	179	153
10	1.0	2.28	684	456	342	274	228	195	171	152	137	109	91.2	78.2
	1.5	2.79	837	558	419	335	279	239	209	186	167	134	112	95.7
	2.0	3.23	969	646	485	388	323	277	242	215	194	155	129	111
	3.0	3.95	1185	790	593	474	395	339	296	263	237	190	158	135
	4.0	4.56	1368	912	684	547	456	391	342	304	274	219	182	156
	5.0	5.10	1530	1020	765	612	510	437	383	340	306	245	204	175
	7.0	5.59	1677	1118	839	671	559	479	419	373	335	268	224	192
12	1.0	6.03	1809	1206	905	724	603	517	452	402	362	289	241	207
	1.5	2.73	819	546	410	328	273	234	205	182	164	131	109	93.6
	2.0	3.34	1002	668	501	401	334	286	251	223	200	160	134	115
	3.0	3.86	1158	772	579	463	386	331	290	257	232	185	154	132
	4.0	4.73	1419	946	710	568	473	405	355	315	284	227	189	162
	5.0	5.46	1638	1092	819	655	546	468	410	364	328	262	218	187
	7.0	6.11	1833	1222	917	737	611	524	458	407	367	293	244	209
15	1.0	6.69	2007	1338	1004	803	669	573	502	446	401	321	268	229
	1.5	7.23	2169	1446	1085	868	723	620	542	482	434	347	289	248
	2.0	3.42	1026	684	513	410	342	293	257	228	205	164	137	117
	3.0	4.19	1257	838	629	503	419	359	314	279	251	201	168	144
	4.0	4.83	1449	966	725	580	483	414	362	322	290	232	193	166
	5.0	5.92	1776	1184	888	710	592	507	444	395	355	284	237	203
	7.0	6.84	2052	1368	1026	821	684	586	513	456	410	328	274	235
20	1.0	7.64	2292	1528	1146	917	764	655	573	509	458	367	306	262
	1.5	8.37	2511	1674	1256	1004	837	717	628	558	502	402	335	287
	2.0	9.04	2712	1808	1356	1085	904	775	678	603	542	434	362	310
	3.0	4.56	1368	912	684	547	456	391	342	304	274	219	182	156
	4.0	5.58	1674	1116	837	670	558	478	419	372	335	268	223	191
	5.0	6.44	1932	1288	966	773	644	552	483	429	386	30		



# UNIVERSAL APPLICATION RATE CHART FOR 75 CM TIP SPACING

TIP CAPACITY	LIQUID PRESSURE IN bar	CAPACITY 1 NOZZLE IN l/min	l/ha – 75 cm NOZZLE SPACING												
			4 km/h	6 km/h	8 km/h	10 km/h	12 km/h	14 km/h	16 km/h	18 km/h	20 km/h	25 km/h	30 km/h	35 km/h	
01	1.0	0.23	46.0	30.7	23.0	18.4	15.3	13.1	11.5	10.2	9.2	7.4	6.1	5.3	
	1.5	0.28	56.0	37.3	28.0	22.4	18.7	16.0	14.0	12.4	11.2	9.0	7.5	6.4	
	2.0	0.32	64.0	42.7	32.0	25.6	21.3	18.3	16.0	14.2	12.8	10.2	8.5	7.3	
	3.0	0.39	78.0	52.0	39.0	31.2	26.0	22.3	19.5	17.3	15.6	12.5	10.4	8.9	
	4.0	0.45	90.0	60.0	45.0	36.0	30.0	25.7	22.5	20.0	18.0	14.4	12.0	10.3	
	5.0	0.50	100	66.7	50.0	40.0	33.3	28.5	25.0	22.2	20.0	16.0	13.3	11.4	
	7.0	0.60	120	80.0	60.0	48.0	40.0	36.7	31.4	27.5	24.4	22.0	17.6	14.7	12.6
10	0.70	140	93.3	70.0	56.0	46.7	40.0	35.0	31.1	28.0	22.4	18.7	16.0	14.1	
015	1.0	0.34	68.0	45.3	34.0	27.2	22.7	19.4	17.0	15.1	13.6	10.9	9.1	7.8	
	1.5	0.42	84.0	56.0	42.0	33.6	28.0	24.0	21.0	18.7	16.8	13.4	11.2	9.6	
	2.0	0.48	96.0	64.0	48.0	38.4	32.0	27.4	24.0	21.3	19.2	15.4	12.8	11.0	
	3.0	0.59	118	78.7	59.0	47.2	39.3	33.7	29.5	26.2	23.6	18.9	15.7	13.5	
	4.0	0.68	136	90.7	68.0	54.4	45.3	38.9	34.0	30.2	27.2	21.8	18.1	15.5	
	5.0	0.76	152	101	76.0	60.8	50.7	43.4	38.0	33.8	30.4	24.3	20.3	17.4	
	7.0	0.83	166	111	83.0	66.4	55.3	47.4	41.5	36.9	33.2	26.6	22.1	19.0	
10	0.90	180	120	90.0	72.0	60.0	51.4	45.0	40.0	36.0	28.8	24.0	20.6		
02	1.0	0.46	92.0	61.3	46.0	36.8	30.7	26.3	23.0	20.4	18.4	14.7	12.3	10.5	
	1.5	0.56	112	74.7	56.0	44.8	37.3	32.0	28.0	24.9	22.4	17.9	14.9	12.8	
	2.0	0.65	130	86.7	65.0	52.0	43.3	37.1	32.5	28.9	26.0	20.8	17.3	14.9	
	3.0	0.79	158	105	79.0	63.2	52.7	45.1	39.5	35.1	31.6	25.3	21.1	18.1	
	4.0	0.91	182	121	91.0	72.8	60.7	52.0	45.5	40.4	36.4	29.1	24.3	20.8	
	5.0	1.02	204	136	102	81.6	68.0	58.3	51.0	45.3	40.8	32.6	27.2	23.3	
	7.0	1.12	224	149	112	89.6	74.7	64.0	56.0	49.8	44.8	35.8	29.9	25.6	
10	1.21	242	161	121	96.8	80.7	69.1	60.5	53.8	48.4	38.7	32.3	27.7		
025	1.0	0.57	114	76.0	57.0	45.6	38.0	32.6	28.5	25.3	22.8	18.2	15.2	13.0	
	1.5	0.70	140	93.3	70.0	56.0	46.7	40.0	35.0	31.1	28.0	22.4	18.7	16.0	
	2.0	0.81	162	108	81.0	64.8	54.0	46.3	40.5	36.0	32.4	25.9	21.6	18.5	
	3.0	0.99	198	132	99.0	79.2	66.0	56.6	49.5	44.0	39.6	31.7	26.4	22.6	
	4.0	1.14	228	152	114	91.2	76.0	65.1	57.0	50.7	45.6	36.5	30.4	26.1	
	5.0	1.28	256	171	128	102	85.3	73.1	64.0	56.9	51.2	41.0	34.1	29.3	
	7.0	1.40	280	187	140	112	93.3	80.0	70.0	62.2	56.0	44.8	37.3	32.0	
10	1.51	302	201	151	121	101	86.3	75.5	67.1	60.4	48.3	40.3	34.5		
03	1.0	0.68	136	90.7	68.0	54.4	45.3	38.9	34.0	30.2	27.2	21.8	18.1	15.5	
	1.5	0.83	166	111	83.0	66.4	55.3	47.4	41.5	36.9	33.2	26.6	22.1	19.0	
	2.0	0.96	192	128	96.0	76.8	64.0	54.9	48.0	42.7	38.4	30.7	25.6	21.9	
	3.0	1.18	236	157	118	94.4	78.7	67.4	59.0	52.4	47.2	37.8	31.5	27.0	
	4.0	1.36	272	181	136	109	90.7	77.7	68.0	60.4	54.4	43.5	36.3	31.1	
	5.0	1.52	304	203	152	122	101	85.9	76.0	67.6	60.8	48.6	40.5	34.7	
	7.0	1.67	334	223	167	134	111	95.4	83.5	74.2	66.8	53.4	44.5	38.2	
10	1.80	360	240	180	144	120	103	90.0	80.0	72.0	57.6	48.0	41.1		
035	1.0	0.80	160	107	80.0	64.0	53.3	45.7	40.0	35.6	32.0	25.6	21.3	18.3	
	1.5	0.98	196	131	98.0	78.4	65.3	56.0	49.0	43.6	39.2	31.4	26.1	22.4	
	2.0	1.13	226	151	113	90.4	75.3	64.6	56.5	50.2	45.2	36.2	30.1	25.8	
	3.0	1.38	276	184	138	110	92.0	78.9	69.0	61.3	55.2	44.2	36.8	31.5	
	4.0	1.59	318	212	159	127	106	90.9	79.5	70.7	63.6	50.9	42.4	36.3	
	5.0	1.78	356	237	178	142	119	102	89.0	79.1	71.2	57.0	47.5	40.7	
	7.0	1.95	390	260	195	156	130	111	97.5	86.7	78.0	62.4	52.0	44.6	
10	2.11	422	281	211	169	141	121	106	93.8	84.4	67.5	56.3	48.2		
04	1.0	0.91	182	121	91.0	72.8	60.7	52.0	45.5	40.4	36.4	29.1	24.3	20.8	
	1.5	1.12	224	149	112	89.6	74.7	64.0	56.0	49.8	44.8	35.8	29.9	25.6	
	2.0	1.29	258	172	129	103	86.0	73.7	64.5	57.3	51.6	41.3	34.4	29.5	
	3.0	1.58	316	211	158	126	105	90.3	79.0	70.2	63.2	50.6	42.1	36.1	
	4.0	1.82	364	243	182	144	121	104	91.0	80.9	72.8	58.2	48.5	41.6	
	5.0	2.04	408	272	204	163	136	117	102	90.7	81.6	65.3	54.4	46.6	
	7.0	2.23	446	297	223	178	149	127	112	99.1	89.2	71.4	59.5	51.0	
10	2.41	482	321	241	193	161	138	121	107	96.4	77.1	64.3	55.1		
05	1.0	1.14	228	152	114	91.2	76.0	65.1	57.0	50.7	45.6	36.5	30.4	26.1	
	1.5	1.39	278	185	139	111	92.7	79.4	69.5	61.8	55.6	44.5	37.1	31.8	
	2.0	1.61	322	215	161	129	107	92.0	80.5	71.6	64.4	51.5	42.9	36.8	
	3.0	1.97	394	263	197	158	131	113	98.5	87.6	78.8	63.0	52.5	45.0	
	4.0	2.27	454	303	227	182	151	130	114	101	90.8	72.6	60.5	51.9	
	5.0	2.54	508	339	254	203	169	145	127	113	102	81.3	67.7	58.1	
	7.0	2.79	558	372	279	223	186	159	140	124	112	89.3	74.4	63.8	
10	3.01	602	401	301	241	201	172	151	134	120	96.3	80.3	68.8		
06	1.0	1.37	274	183	137	110	91.3	78.3	68.5	60.9	54.8	43.8	36.5	31.3	
	1.5	1.68	336	224	168	134	112	96.0	84.0	74.7	67.2	53.8	44.8	38.4	
	2.0	1.94	388	259	194	155	129	111	97.0	86.2	77.6	62.1	51.7	44.3	
	3.0	2.37	474	316	237	190	158	135	119	105	94.8	75.8	63.2	54.2	
	4.0	2.74	548	365	274	219	183	157	137	122	110	87.7	73.1	62.6	
	5.0	3.06	612	408	306	245	204	175	153	136	122	97.9	81.6	69.9	
	7.0	3.35	670	447	335	268	223	191	168	149	134	107	89.3	76.6	
10	3.62	724	483	362	290	241	207	181	161	145	116	96.5	82.7		
08	1.0	1.82	364	243	182	146	121	104	91.0	80.9	72.8	58.2	48.5	41.6	
	1.5	2.23	446	297	223	178	149	127	112	99.1	89.2	71.4	59.5	51.0	
	2.0	2.58	516	344	258	206	172	147	129	115	103	82.6	68.8	59.0	
	3.0	3.16	632	421	316	253	211	181	158	140	126	101	84.3	72.2	
	4.0	3.65	730	487	365	292	243	209	183	162	146	117	97.3	83.4	
	5.0	4.08	816	544	408	326	272	233	204	181	163	131	109	93.3	
	7.0	4.47	894	596	447	358	298	255	224	199	179	143	119	102	
10	4.83	966	644	483	386	322	276	242	215	193	155	129	110		
10	1.0	2.28	456	304	228	182	152	130	114	101	91.2	73.0	60.8	52.1	
	1.5	2.79	558	372	279	223	186	159	140	124	112	89.3	74.4	63.8	
	2.0	3.23	646	431	323	258	215	185	162	144	129	103	86.1	73.8	
	3.0	3.95	790	527	395	316	263	226	198	176	158	126	105	90.3	
	4.0	4.56	912	608	456	365	304	261	228	203	182	146	122	104	
	5.0	5.10	1020	680	510	408	340	291	255	227	204	163	136	117	
	7.0	5.59	1118	745	559	447	373	319	280	248	224	179	149	128	
10	6.03	1206	804	603	482	402	345	302	268	241	193	161	138		
12	1.0	2.73	546	364	273	218	182	156	137	121	109	87.4	72.8	62.4	
	1.5	3.34	668	445	334	267	223	191	167	148	134	107	89.1	76.3	
	2.0	3.86	772	515	386	309	257	221	193	172	154	124	103	88.2	
	3.0	4.73	946	631	473	378	315	270	237	210	189	151	126	108	
	4.0	5.46	1092	728	546	437	364	312	273	243	218	175	146	125	
	5.0	6.11	1222	815	611	489	407	349	306	272	244	196	163	140	
	7.0	6.69	1338	892	669	535	446	382	335	297	268	214	178	153	
10	7.23	1446	964	723	578	482	413	362</							

## WATER SENSITIVE PAPER

These specially coated papers are used for evaluating spray distributions, swath widths, droplet densities and penetration of spray. Water sensitive paper is yellow and is stained blue by exposure to aqueous spray droplets. For more information on water sensitive paper see Data Sheet 20301.

Water sensitive paper sold by TeeJet Technologies is manufactured by Syngenta Crop Protection AG.

PART NUMBER	PAPER SIZE (mm)	QTY/PKG
20301-1N	76 x 26	50 Cards
20301-2N	76 x 52	50 Cards
20301-3N	500 x 26	25 Strips

### HOW TO ORDER

2 0 3 0 1 - 1 N



## TEEJET TIP CLEANING BRUSH

### HOW TO ORDER

C P 2 0 0 1 6 - N Y



## TEEJET CALIBRATION CONTAINER

The TeeJet Calibration Container features a 2.0 L capacity and a raised dual scale in both U.S. and metric graduations. The container is molded of polypropylene for excellent chemical resistance and durability.

### HOW TO ORDER

C P 2 4 0 3 4 A - P P



## USEFUL FORMULAS

$$\text{l/min (per nozzle)} = \frac{\text{l/ha} \times \text{km/h} \times \text{W}}{60,000}$$

$$\text{l/ha} = \frac{60,000 \times \text{l/min (per nozzle)}}{\text{km/h} \times \text{W}}$$

l/min – Liters Per Minute

l/ha – Liters Per Hectare

km/h – Kilometers Per Hour

W – Nozzle spacing (in cm) for broadcast spraying

– Spray width (in cm) for single nozzle, band spraying or boomless spraying

– Row spacing (in cm) divided by the number of nozzles per row for directed spraying



## USEFUL FORMULAS FOR ROADWAY APPLICATIONS

$$\text{l/km} = \frac{60 \times \text{l/min}}{\text{km/h}} \quad \text{l/min} = \frac{\text{l/km} \times \text{km/h}}{60}$$

l/km = Liters Per Lane Kilometer

**Note:** l/km is not a normal volume per unit area measurement. It is a volume per distance measurement. Increases or decreases in lane width (swath width) are not accommodated by these formulas.

## MEASURING TRAVEL SPEED

Measure a test course in the area to be sprayed or in an area with similar surface conditions. Minimum lengths of 30 and 60 meters are recommended for measuring speeds up to 8 and 14 km/h, respectively. Determine the time required to travel the test course. To help ensure accuracy, conduct the speed check with a partially loaded (about half full) sprayer and select the engine throttle setting and gear that will be used when spraying. Repeat the above process and average the times that were measured. Use the following equation or the table at right to determine ground speed.

$$\text{Speed (km/h)} = \frac{\text{Distance (m)} \times 3.6}{\text{Time (seconds)}}$$

## SPEEDS

SPEED IN km/h	TIME REQUIRED IN SECONDS TO TRAVEL A DISTANCE OF:			
	30 m	60 m	90 m	120 m
5	22	43	65	86
6	18	36	54	81
7	15	31	46	62
8	14	27	41	64
9	—	24	36	48
10	—	22	32	43
11	—	20	29	39
12	—	18	27	36
13	—	17	25	33
14	—	15	23	31
16	—	14	20	27
18	—	—	18	24
20	—	—	16	22
25	—	—	13	17
30	—	—	—	14
35	—	—	—	12
40	—	—	—	11

## NOZZLE SPACING

If the nozzle spacing on your boom is different than those tabulated, multiply the tabulated l/ha coverages by one of the following factors. Different application rate charts for different spacing can be found on pages 179–182.

50 cm SPACING	
OTHER SPACING (cm)	CONVERSION FACTOR
20	2.5
25	2
30	1.67
35	1.43
40	1.25
45	1.11
60	.83
70	.71
75	.66

75 cm SPACING	
OTHER SPACING (cm)	CONVERSION FACTOR
40	1.88
45	1.67
50	1.5
60	1.25
70	1.07
80	.94
90	.83
110	.68
120	.63

100 cm SPACING	
OTHER SPACING (cm)	CONVERSION FACTOR
70	1.43
75	1.33
80	1.25
85	1.18
90	1.11
95	1.05
105	.95
110	.91
120	.83

## MISCELLANEOUS CONVERSION FACTORS

1 Hectare	= 10,000 Square Meter	= 2.471 Acres
1 Acre	= 0.405 Hectare	
1 Liter per Hectare	= 0.1069 Gallon per Acre	
One Kilometer	= 1,000 Meters	= 3,300 Feet
	= 0.621 Mile	
1 Liter	= 0.26 Gallon	= 0.22 Imperial Gallon
1 Bar	= 100 Kilopascals	= 14.5 Pounds per Square Inch
1 Kilometer per Hour	= 0.62 Mile per Hour	

## SUGGESTED MINIMUM SPRAY HEIGHTS

The nozzle height suggestions in the table below are based on the minimum overlap required to obtain uniform distribution. However, in many cases, typical height adjustments are based on a 1:1 nozzle spacing to height ratio. For example, 110° flat spray tips spaced 50 cm apart are commonly set 50 cm above the target.

TIP MODEL	ANGLE	HEIGHT (cm)		
		50 cm SPACING	75 cm SPACING	100 cm SPACING
TP, TJ	65°	75	100	NR*
TP, XR, TX, DG, TJ, AI, XRC	80°	60	80	NR*
TP, XR, DG, TT, TTI, TJ, DGTJ, AI, AIXR, AIC, XRC, TTJ, AITTJ, TT160, APTJ	110°	40	60	NR*
FullJet®	120°	40**	60**	75**
FloodJet® TK, TF, K, QCK, QCTE, 1/4TTJ	120°	40***	60***	75***

\* Not recommended.

\*\* Nozzle height based on 30°–45° angle of orientation.

\*\*\* Wide angle spray tip height is influenced by nozzle orientation. The critical factor is to achieve a double spray pattern overlap.



## SPRAYING LIQUIDS WITH A DENSITY OTHER THAN WATER

Since all the tabulations in this catalog are based on spraying water, which weighs 1 kg per USA gallon, conversion factors must be used when spraying liquids that are heavier or lighter than water. To determine the proper size nozzle for the liquid to be sprayed, first multiply the desired l/min or l/ha of liquid by the water rate conversion factor. then use the new converted l/min or l/ha rate to select the proper size nozzle.



### Example:

Desired application rate is 100 l/ha of a liquid that has a density of 1.28 kg/L. Determine the correct nozzle size as follows:

$$\begin{aligned} \text{l/ha (liquid other than water)} \times \text{Conversion factor} &= \text{l/ha (from table in catalog)} \\ 100 \text{ l/ha (1.28 kg/L solution)} \times 1.13 &= 113 \text{ l/ha (water)} \end{aligned}$$

The applicator should choose a nozzle size that will supply 113 l/ha of water at the desired pressure.

SPECIFIC GRAVITY	CONVERSION FACTOR
0.84	0.92
0.96	0.98
1.00–Water	1.00
1.08	1.04
1.20	1.10
1.28–28% Nitrogen	1.13
1.32	1.15
1.44	1.20
1.68	1.30

## SPRAY COVERAGE INFORMATION

This table lists the theoretical coverage of spray patterns as calculated from the included spray angle of the spray and the distance from the nozzle orifice. These values are based on the assumption that the spray angle remains the same throughout the entire spray distance. In actual practice, the tabulated spray angle does not hold for long spray distances.

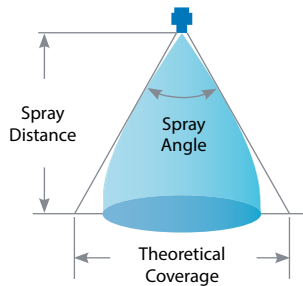

INCLUDED SPRAY ANGLE	THEORETICAL COVERAGE AT VARIOUS SPRAY HEIGHTS							
	20 cm	30 cm	40 cm	50 cm	60 cm	70 cm	80 cm	90 cm
15°	5.3	7.9	10.5	13.2	15.8	18.4	21.1	23.7
20°	7.1	10.6	14.1	17.6	21.2	24.7	28.2	31.7
25°	8.9	13.3	17.7	22.2	26.6	31.0	35.5	39.9
30°	10.7	16.1	21.4	26.8	32.2	37.5	42.9	48.2
35°	12.6	18.9	25.2	31.5	37.8	44.1	50.5	56.8
40°	14.6	21.8	29.1	36.4	43.7	51.0	58.2	65.5
45°	16.6	24.9	33.1	41.4	49.7	58.0	66.3	74.6
50°	18.7	28.0	37.3	46.6	56.0	65.3	74.6	83.9
55°	20.8	31.2	41.7	52.1	62.5	72.9	83.3	93.7
60°	23.1	34.6	46.2	57.7	69.3	80.8	92.4	104
65°	25.5	38.2	51.0	63.7	76.5	89.2	102	115
73°	29.6	44.4	59.2	74.0	88.8	104	118	133
80°	33.6	50.4	67.1	83.9	101	118	134	151
85°	36.7	55.0	73.3	91.6	110	128	147	165
90°	40.0	60.0	80.0	100	120	140	160	180
95°	43.7	65.5	87.3	109	131	153	175	196
100°	47.7	71.5	95.3	119	143	167	191	215
110°	57.1	85.7	114	143	171	200	229	257
120°	69.3	104	139	173	208	243	—	—
130°	85.8	129	172	215	257	—	—	—
140°	110	165	220	275	—	—	—	—
150°	149	224	275	—	—	—	—	—

## NOZZLE NOMENCLATURE

There are many types of nozzles available, with each providing different flow rates, spray angles, droplet sizes and patterns. Some of these spray tip characteristics are indicated by the tip number.

**Remember, when replacing tips, be sure to purchase the same tip type, angle, and capacity, thereby ensuring your sprayer remains properly calibrated.**

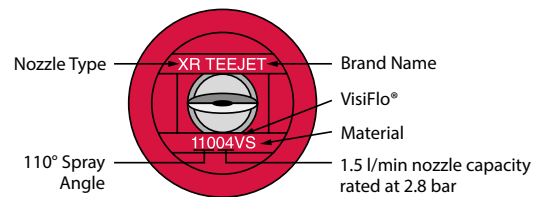



## FLOW RATE

Nozzle flow rate varies with spraying pressure. In general, the relationship between l/min and pressure is as follows:

$$\frac{l/min_1}{l/min_2} = \frac{\sqrt{bar_1}}{\sqrt{bar_2}}$$

This equation is explained by the illustration to the right. Simply stated, in order to double the flow through a nozzle, the pressure must be increased four times.

Higher pressure not only increases the flow rate through a nozzle, but it also influences the droplet size, spray angle, and the rate of orifice wear. As pressure is increased, the droplet size decreases and the rate of orifice wear increases.

The values given in the tabulation sections of this catalog indicate the most commonly used pressure ranges for the associated spray tips. When information on the performance of spray tips outside of the pressure range given in this catalog is required, contact TeeJet Technologies or your local rep.

## SPRAY ANGLE & COVERAGE

Depending on the nozzle type and size, the operating pressure can have a significant effect on spray angle and quality of spray distribution. As shown here for an 11002 flat spray tip, lowering the pressure results in a smaller spray angle and a significant reduction in spray coverage.

Tabulations for spray tips in this catalog are based on spraying water. Generally, liquids more viscous than water produce relatively smaller spray angles, while liquids with surface tensions lower than water will produce wider spray angles. In situations where the uniformity of spray distribution is important, be careful to operate your spray tips within the proper pressure range.

**Note:** Suggested minimum spray heights for broadcast spraying are based upon nozzles spraying water at the rated spray angle.

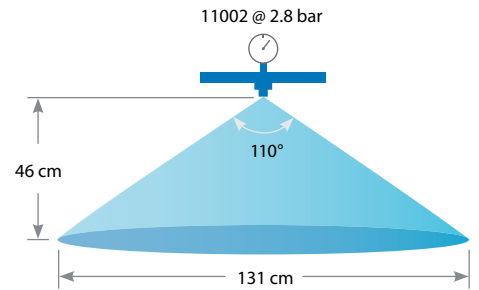
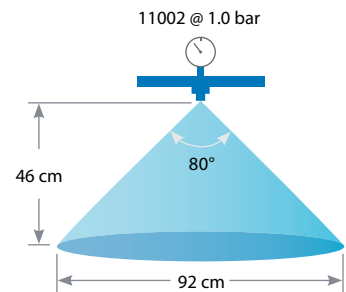
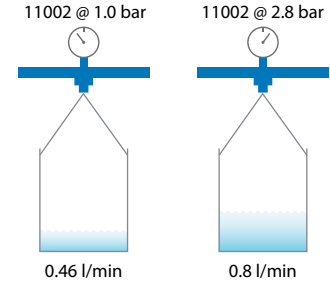

## PRESSURE DROP THROUGH VARIOUS HOSE SIZES

FLOW IN l/min	PRESSURE DROP IN bar (3 m LENGTH WITHOUT COUPLINGS)									
	6.4 mm		9.5 mm		12.7 mm		19.0 mm		25.4 mm	
	bar	kPa	bar	kPa	bar	kPa	bar	kPa	bar	kPa
1.9	0.1	9.6		1.4						
3.8				4.8						
5.8			0.1	9.6		2.8				
7.7			0.2	16.5		4.1				
9.6			0.2	23.4	0.1	6.2				
11.5					0.1	8.3				
15.4					0.1	13.8				
19.2					0.2	20.0		2.8		
23.1					0.3	27.6		4.1		
30.8							0.1	6.2		2.1
38.5							0.1	9.6		2.8

## HELPFUL REMINDERS FOR BAND SPRAYING

Wider angle spray tips allow the spray height to be lowered to minimize drift.

The spray angle of the nozzle and the resulting band width are directly influenced by the spraying pressure.

**Example:** Even Flat Spray

**Example:** 8002E Even Flat Spray

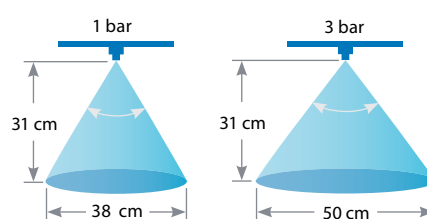
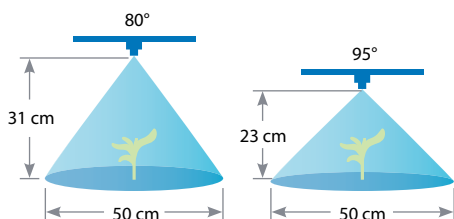

**Use Care When Calculating:**  
Field Acres/Hectares vs. Treated Acres/Hectares

$$\text{Field Acres/Hectares} = \frac{\text{Total Acres/Hectares of Planted Cropland}}{\text{Treated Acres/Hectares}}$$

$$\text{Treated Acres/Hectares} = \text{Field Acres/Hectares} \times \frac{\text{Band Width}}{\text{Row Spacing}}$$

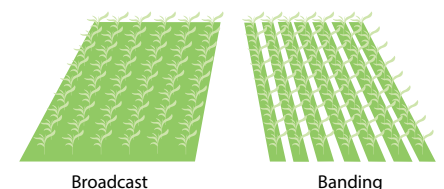



# PRESSURE DROP THROUGH SPRAYER COMPONENTS

COMPONENT NUMBER	TYPICAL PRESSURE DROP (bar) AT VARIOUS FLOW RATES (l/min)																					
	2.0 l/min	3.0 l/min	4.0 l/min	5.0 l/min	7.5 l/min	10 l/min	15 l/min	20 l/min	25 l/min	30 l/min	40 l/min	50 l/min	75 l/min	100 l/min	150 l/min	200 l/min	250 l/min	300 l/min	375 l/min	450 l/min	550 l/min	750 l/min
AA2 GunJet			0.02	0.03	0.06	0.11	0.26	0.45	0.71	1.02	1.82	2.84										
AA18 GunJet		0.02	0.04	0.07	0.16	0.28	0.62	1.10	1.72	2.48	4.42											
AA30L GunJet		0.03	0.05	0.07	0.17	0.30	0.67	1.19	1.86	2.67	4.75											
AA43 GunJet						0.02	0.05	0.08	0.13	0.18	0.32	0.51	1.14	2.02	4.55							
AA143 GunJet						0.02	0.04	0.07	0.10	0.15	0.27	0.42	0.94	1.68	3.78							
AA6B Valve						0.02	0.03	0.06	0.10	0.14	0.25	0.38	0.87	1.54	3.46							
AA17 Valve						0.02	0.03	0.06	0.10	0.14	0.25	0.38	0.87	1.54	3.46							
AA144A/144P Valve						0.02	0.03	0.06	0.10	0.14	0.25	0.38	0.87	1.54	3.46							
AA144A-1-3/AA144P-1-3 Valve				0.02	0.04	0.09	0.15	0.24	0.34	0.60	0.94	2.13	3.78									
AA145H Valve						0.02	0.04	0.07	0.09	0.17	0.26	0.59	1.05	2.35	4.19							
344 2-way Valve										0.02	0.04	0.06	0.13	0.23	0.52	0.93	1.45	2.09	3.27			
344 3-way Valve								0.02	0.03	0.04	0.07	0.10	0.23	0.41	0.92	1.64	2.57	3.70				
346 2-way Valve														0.02	0.05	0.09	0.15	0.21	0.33	0.48	0.72	1.33
346 3-way Valve													0.03	0.06	0.13	0.23	0.36	0.52	0.82	1.18	1.76	3.27
356 Valve														0.02	0.05	0.09	0.15	0.21	0.33	0.48	0.72	1.33
430 2-way* Manifold						0.02	0.04	0.07	0.11	0.16	0.28	0.44	0.99	1.76	3.95							
430 3-way* Manifold						0.02	0.04	0.07	0.11	0.16	0.28	0.44	0.99	1.76	3.95							
430 FB* Manifold				0.02	0.03	0.06	0.11	0.17	0.25	0.44	0.69	1.56	2.78									
440* Manifold									0.02	0.03	0.06	0.09	0.20	0.35	0.80	1.42	2.21	3.19				
450* Manifold										0.02	0.04	0.06	0.13	0.23	0.52	0.93	1.45	2.09	3.27			
450 FB* Manifold										0.02	0.04	0.06	0.13	0.23	0.52	0.93	1.45	2.09	3.27			
460 2-way* Manifold								0.02	0.02	0.03	0.06	0.09	0.21	0.38	0.85	1.51	2.35	3.39				
460 3-way* Manifold								0.02	0.02	0.03	0.06	0.09	0.21	0.38	0.85	1.51	2.35	3.39				
460 FB* Manifold								0.02	0.03	0.04	0.07	0.10	0.23	0.41	0.92	1.64	2.57	3.70				
490* Manifold														0.02	0.05	0.09	0.15	0.21	0.33	0.48	0.72	1.33
530A 2-Way Manual & Electric Manifold*					0.01	0.02	0.04	0.07	0.11	0.16	0.29	0.45	1.01	1.80	4.04							
530A 3-Way Manual & Electric Manifold*				0.01	0.02	0.04	0.09	0.15	0.24	0.34	0.60	0.94	2.13	3.78								
530A FB Electric Manifold*				0.01	0.03	0.05	0.11	0.19	0.30	0.44	0.77	1.21	2.72	4.84								
540* Manifold																						
QJ300 Nozzle Body		0.02	0.03	0.05	0.11	0.20	0.44	0.78	1.22	1.76	3.12											
QJ360C Nozzle Body	0.02	0.04	0.08	0.12	0.26	0.47	1.06	1.88	2.94													
QJ360E Nozzle Body	0.04	0.09	0.17	0.26	0.59	1.05	2.35															
QJ360F Nozzle Body		0.02	0.03	0.05	0.11	0.20	0.46	0.82	1.28	1.84	3.27											
QJ373	0.01	0.03	0.06	0.09	0.20	0.35	0.80	1.42	2.21	3.19												
QJ375	0.02	0.04	0.07	0.10	0.23	0.41	0.92	1.64	2.57	3.70												
QJ380 Nozzle Body		0.02	0.04	0.07	0.15	0.26	0.59	1.05	1.64	2.35	4.19											
QJ380F Nozzle Body			0.02	0.03	0.07	0.12	0.26	0.47	0.74	1.06	1.88	2.94										
24230A/24216A Nozzle Body	0.04	0.08	0.15	0.23	0.51	0.91	2.06	3.65														
QJ17560A Nozzle Body	0.02	0.04	0.08	0.12	0.26	0.47	1.06	1.88	2.94													
AA122-1/2 Line Strainer						0.02	0.04	0.07	0.10	0.15	0.27	0.42	0.94	1.68	3.78							
AA122-3/4 Line Strainer							0.02	0.04	0.06	0.09	0.15	0.24	0.53	0.94	2.13	3.78						
AA122-QC Line Strainer							0.02	0.03	0.05	0.07	0.12	0.18	0.41	0.74	1.65	2.94						
AA126-3 Line Strainer								0.02	0.03	0.04	0.07	0.11	0.25	0.45	1.01	1.80	2.81	4.04				
AA126-4/F50/M50 Line Strainer										0.02	0.03	0.05	0.11	0.20	0.44	0.78	1.22	1.76	2.74	3.95		
AA126-5 Line Strainer												0.02	0.04	0.07	0.15	0.27	0.43	0.62	0.96	1.38	2.07	3.85
AA126-6/F75 Line Strainer													0.02	0.04	0.09	0.16	0.25	0.36	0.56	0.81	1.21	2.26

\*Manifold pressure drop data based on a single valve. Quantity of valves, inlet fitting size and inlet feed setup may affect pressure drop rating. Please contact your local TeeJet sale representative for additional information.

It is essential to know the amount of area that you intend to cover when applying a pesticide or fertilizer. Turf areas such as home lawns and golf course greens, tees and fairways should be measured in square feet or acres, depending upon the units needed.

## RECTANGULAR AREAS

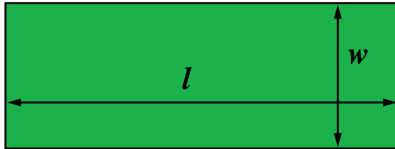

$$\text{Area} = \text{Length } (l) \times \text{Width } (w)$$



### EXAMPLE

What is the area of a lawn that is 150 meters long and 75 meters wide?

$$\text{Area} = 150 \text{ meters} \times 75 \text{ meters} = 11,250 \text{ square meters}$$

By using the following equation, it is possible to determine the area in hectares.

$$\text{Area in hectares} = \frac{\text{Area in square meters}}{10,000 \text{ square meters per hectare}}$$

(There are 10,000 square meters in a hectare.)



### EXAMPLE

$$\begin{aligned} \text{Area in hectares} &= \frac{11,250 \text{ square meters}}{10,000 \text{ square meters per hectare}} \\ &= 1.125 \text{ hectares} \end{aligned}$$

## TRIANGULAR AREAS

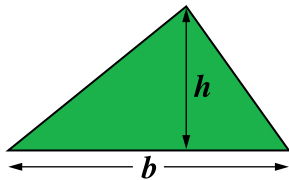

$$\text{Area} = \frac{\text{Base } (b) \times \text{Height } (h)}{2}$$



### EXAMPLE

The base of a corner lot is 120 meters while the height is 50 meters. What is the area of the lot?

$$\begin{aligned} \text{Area} &= \frac{120 \text{ meters} \times 50 \text{ meters}}{2} \\ &= 3,000 \text{ square meters} \end{aligned}$$

$$\begin{aligned} \text{Area in hectares} &= \frac{3,000 \text{ square meters}}{10,000 \text{ square meters per hectare}} \\ &= 0.30 \text{ hectare} \end{aligned}$$

## CIRCULAR AREAS

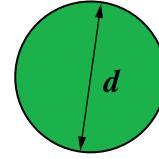

$$\begin{aligned} \text{Area} &= \frac{\pi \times \text{Diameter}^2 (d)}{4} \\ \pi &= 3.14159 \end{aligned}$$



### EXAMPLE

What is the area of a green that has a diameter of 15 meters?

$$\begin{aligned} \text{Area} &= \frac{\pi \times (15 \text{ meters})^2}{4} = \frac{3.14 \times 225}{4} \\ &= 177 \text{ square meters} \\ \text{Area in hectares} &= \frac{177 \text{ square meters}}{10,000 \text{ square meters per hectare}} \\ &= 0.018 \text{ hectare} \end{aligned}$$

## IRREGULAR AREAS

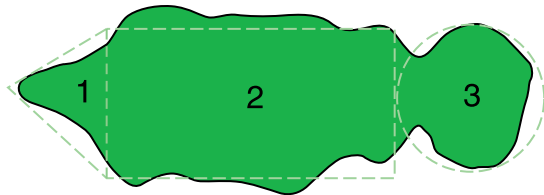

Any irregularly shaped turf area can usually be reduced to one or more geometric figures. The area of each figure is calculated and the areas are then added together to obtain the total area.



### EXAMPLE

What is the total area of the Par-3 hole illustrated above?

The area can be broken into a triangle (area 1), a rectangle (area 2) and a circle (area 3). Then use the previously mentioned equations for determining areas to find the total area.

$$\begin{aligned} \text{Area 1} &= \frac{15 \text{ meters} \times 20 \text{ meters}}{2} = 150 \text{ square meters} \\ \text{Area 2} &= 15 \text{ meters} \times 150 \text{ meters} = 2,250 \text{ square meters} \\ \text{Area 3} &= \frac{3.14 \times (20)^2}{4} = 314 \text{ square meters} \\ \text{Total Area} &= 150 + 2,250 + 314 = 2,714 \text{ square meters} \\ &= \frac{2,714 \text{ square meters}}{10,000 \text{ square meters per hectare}} = 0.27 \text{ hectare} \end{aligned}$$

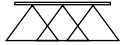

## BROADCAST APPLICATION

Sprayer calibration (1) readies your sprayer for operation and (2) diagnoses tip wear. This will give you optimum performance of your TeeJet tips.

### Equipment Needed:

- TeeJet Calibration Container
- Calculator
- TeeJet Cleaning Brush
- One new TeeJet Spray Tip matched to the tips on your sprayer
- Stopwatch or wristwatch with second hand

## STEP NUMBER 1



### Check Your Tractor/Sprayer Speed!

Knowing your real sprayer speed is an essential part of accurate spraying. Speedometer readings and some electronic measurement devices can be inaccurate because of wheel slippage. Check the time required to move over a 30- or 60-meter strip on your field. Fence posts can serve as permanent markers. The starting post should be far enough away to permit your tractor/sprayer to reach desired spraying speed. Hold that speed as you travel between the “start” and “end” markers. Most accurate measurement will be obtained with the spray tank half full. Refer to the table on page 184 to calculate your real speed. When the correct throttle and gear settings are identified, mark your tachometer or speedometer to help you control this vital part of accurate chemical application.

## STEP NUMBER 2

$$A = \frac{B+C}{D} \quad \text{The Inputs}$$

<b>Before spraying, record the following:</b>	<b>EXAMPLE:</b>
Spray tip type on your sprayer.....	TT11004 Flat Spray Tip (All tips must be identical)
Recommended application volume.....	190 l/ha (From manufacturer's label)
Measured sprayer speed .....	10 km/h
Tip spacing .....	50 cm



## STEP NUMBER 3

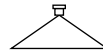

### Calculating Required Nozzle Output



Determine l/min tip output from formula.

$$\text{FORMULA: } l/\text{min} = \frac{l/\text{ha} \times \text{km}/\text{h} \times w}{60,000}$$

$$\text{EXAMPLE: } l/\text{min} = \frac{190 \times 10 \times 50}{60,000}$$

**ANSWER:** 1.58 l/min

## STEP NUMBER 4



### Setting the Correct Pressure

Turn on your sprayer and check for leaks or blockage. Inspect and clean, if necessary, all tips and strainers with TeeJet brush. Replace one tip and strainer with an identical new tip and strainer on sprayer boom.

Check appropriate tip selection table and determine the pressure required to deliver the tip output calculated from the formula in Step 3 for your new tip. Since all of the tabulations are based on spraying water, conversion factors must be used when spraying solutions that are heavier or lighter than water (see page 185).

**EXAMPLE:** (Using above inputs) refer to TeeJet table on page 17 for TT11004 flat spray tip. The table shows that this spray tip delivers 1.58 l/min at 3 bar.

Turn on your sprayer and adjust pressure. Collect and measure the volume of the spray from the new tip for one minute in the collection jar. Fine tune the pressure until you collect 1.58 l/min.

You have now adjusted your sprayer to the proper pressure. It will properly deliver the application rate specified by the chemical manufacturer at your measured sprayer speed.

## STEP NUMBER 5



### Checking Your System

**PROBLEM DIAGNOSIS:** Now, check the flow rate of a few tips on each boom section. If the flow rate of any tip is 10% greater or less than that of the newly installed spray tip, recheck the output of that tip. If only one tip is faulty, replace with new tip and strainer and your system is ready for spraying. However, if a second tip is defective, replace all tips on the entire boom. This may sound unrealistic, but two worn tips on a boom are ample indication of tip wear problems. Replacing only a couple of worn tips invites potentially serious application problems.



### Banding and Directed Applications

The only difference between the above procedure and calibrating for banding or directed applications is the input value used for “W” in the formula in Step 3.

For single tip banding or boomless applications:

$$W = \text{Sprayed band width or swath width (in cm).}$$

For multiple nozzle directed applications:

$$W = \text{Row spacing (in cm) divided by the number of tips per row.}$$

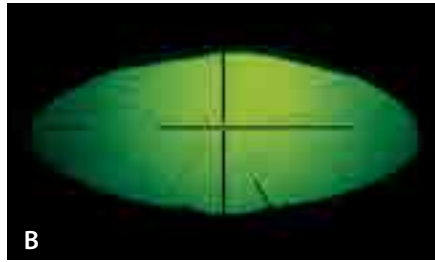
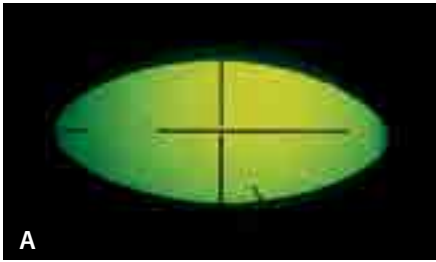

**TIPS DON'T LAST FOREVER!**

There is sufficient evidence that spray tips may be the most neglected component in today's farming. Even in countries with obligatory sprayer testing, spray tips are the most significant failure. On the other hand, they are among the most critical of items in proper application of valuable agricultural chemicals.

Using slightly worn tips is very costly. Water, pesticides, and labor are wasted and pesticide application quality can be compromised.

**AN INSIDE LOOK AT NOZZLE ORIFICE WEAR AND DAMAGE**

While wear may not be detected when visually inspecting a tip, it can be seen when viewed through an optical comparator. The edges of the worn tip (B) appear more rounded than the edges of the new tip (A). Damage to tip (C) was caused by improper cleaning. The spraying results from these tips can be seen in the illustrations below.

**DETERMINING TIP WEAR**

The best way to determine if a spray tip is excessively worn is to compare the flow rate from the used tip to the flow rate of a new tip of the same size and type. Charts in this catalog indicate the flow rates for new tips. Check the flow of each tip by using an accurate graduated collection container, a timing device and an accurate pressure gauge mounted at the nozzle body tip. Compare the flow rate of the old tip to that of the new one. Spray tips are considered excessively worn and should be replaced when their flow exceeds the flow of a new tip by 10%. Reference page 189 for more information.

**SPRAY TIP CARE IS THE FIRST STEP TO SUCCESSFUL APPLICATION**

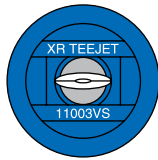

The successful performance of a crop protection product is highly dependent on its proper application as recommended by the product manufacturer. Proper selection and operation of spray nozzles are very important steps in accurate product application. The volume of spray passing through each nozzle plus the droplet size and spray distribution on the target can influence pest control.

Critical in controlling these three factors is the spray nozzle orifice. Careful craftsmanship goes into the precision

manufacturing of each nozzle orifice. ISO standards and European standards require very small flow tolerances of new nozzles (+/-5%) of nominal flow. Many TeeJet spray tip types and sizes are already JKI-approved, which confirms the high quality standard designed into TeeJet nozzles. To maintain the quality in practical spraying as long as possible, the operator's job is the proper maintenance of those spray tips.

The illustration below compares the spraying results obtained from well-maintained vs. poorly-maintained spray tips. Poor spray distribution can be prevented. Selection of longer wearing tip materials or frequent replacement of tips from softer materials can eliminate misapplication due to worn spray tips.

Careful cleaning of a clogged spray tip can mean the difference between a clean field and one with weed streaks. Flat spray tips have finely crafted thin edges around the orifice to control the spray. Even the slightest damage from improper cleaning can cause both an increased flow rate and poor spray distribution. Be sure to use adequate strainers in your spray system to minimize clogging. If a tip does clog, only use a soft bristled brush to clean it—never use a metal object. Use extreme care with soft tip materials such as plastic. Experience has shown that even a wooden toothpick can distort the orifice.

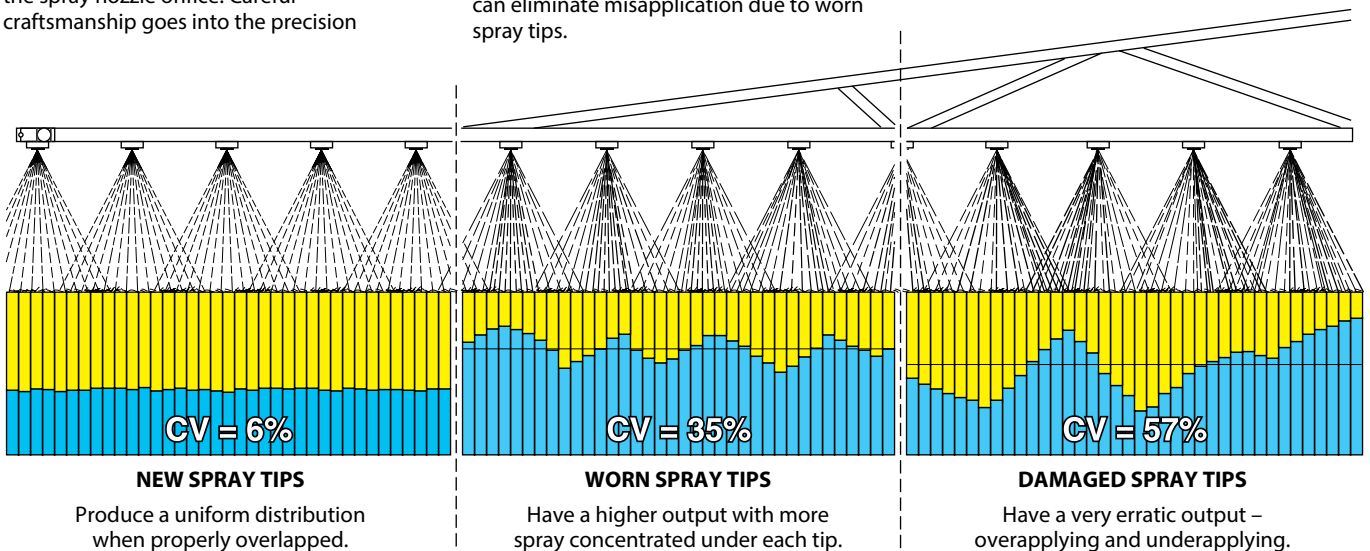

TECHNICAL INFORMATION



One of the most overlooked factors that can dramatically influence the effectiveness of a given crop production product is spray distribution. The uniformity of the spray distribution across the boom or within the spray swath is an essential component of achieving maximum product effectiveness with minimal cost and minimal non-target contamination. It is critical that carrier and product rates are applied at the recommended minimum rate. There are many other factors influencing a crop production product's effectiveness, such as weather, application timing, active ingredient rates, pest infestation, etc. However, an operator must become aware of spray distribution quality if maximum efficiency is expected.

## MEASUREMENT TECHNIQUES

Spray distribution can be measured in different ways. TeeJet Technologies and some sprayer manufacturers, as well as other research and testing stations, have patternators (spray tables) that collect the spray from tips on a standardized or real boom. These patternators have several channels aligned perpendicular to the spray tip, according to the standard ISO 5682-1.

The channels carry the spray liquid into vessels for measuring and analysis (see photo with TeeJet patternator). Under controlled conditions, very accurate distribution measurements can be made for tip evaluation and development. Distribution measurements can also take place on an actual farm sprayer. For static measurements along with the sprayer boom, a patternator equal or very similar to the one described earlier is placed under

the boom in a stationary position or as a small patternator unit scanning the whole boom up to a width of 50 m. Any system of patternator measures electronically the quantity of water in each channel and calculates the values. A distribution quality test gives the applicator important information about the state of the tips on the boom. When much more detailed information about spray quality and coverage is required, a dynamic system—spraying a tracer (dye)—can be used. The same is true if the distribution within the swath on a boom must be measured.

Most of the distribution measuring devices result in data points representing the sprayer's boom swath uniformity. These data points can be very revealing just through visual observation. However, for comparison reasons, a statistical method is widely accepted. This method is Coefficient of Variation (CV). The CV compiles all the patternator data points and summarizes them into a simple percentage, indicating the amount of variation within a given distribution. For extremely uniform distributions under accurate conditions, the calculated CV shall not exceed 10%, according to the ISO 16122-2. As some European countries have stricter CV (e.a. JKI requires a CV lower than 7%) and may require the sprayer's distribution to be tested for uniformity after a certain time. These types of stipulations emphasize the great importance of distribution quality and its effect on crop protection products effectiveness.

TeeJet precisely produces spray tips that match up with the most restrictive requirements in these European countries.

## FACTORS AFFECTING DISTRIBUTION

There are a number of factors contributing to the distribution quality of a spray boom or resulting CV percentage. During a static measurement, the following factors can significantly affect the distribution.

- Spray Tips
  - type
  - pressure
  - spacing
  - spray angle
  - offset angle
  - spray pattern quality
  - flow rate
  - overlap
- Boom Height
- Worn Tips
- Pressure Losses
- Plugged Strainers
- Plugged Tips
- Plumbing Factors Influencing Liquid Turbulence at the Tip

Additionally, in the field during the spraying application or during a dynamic distribution test, the following can influence the distribution quality:

- Boom Stability
  - vertical movement (pitch)
  - horizontal movement (yaw)
- Environmental Conditions
  - wind velocity
  - wind direction
- Pressure Losses (sprayer plumbing)
- Sprayer Speed and Resulting Turbulence

The effect of distribution uniformity on the efficiency of a crop protection product can vary under different circumstances. The crop protection product itself can have a dramatic influence over its efficiency.

Consult the manufacturer's product label or recommendation before spraying.





A spray tip pattern is made up of numerous spray droplets of varying sizes. Droplet size refers to the diameter of an individual spray droplet. Droplet sizes are usually measured in microns (micrometers –  $\mu\text{m}$ ). One micron equals 0.001 mm. The micron is a useful unit of measurement because it is small enough that whole numbers can be used in droplet size measurement.

Since most tips provide a range of droplet sizes (otherwise known as droplet size distribution), it is useful to summarize this with statistical analysis. Advanced droplet size measuring devices are automated, using computers and high-speed illumination sources such as lasers to analyze thousands of droplets in a few seconds. TeeJet Technologies uses the most innovative laser measuring instrumentation to characterize sprays, obtaining droplet size and other important information, such as  $DV_{0.1}$ ,  $DV_{0.5}$  (or VMD),  $DV_{0.9}$ , percentage of driftable fines, and relative span which are used to classify droplet size and the quality of droplets produced by a given spray tip.

Since the smaller droplets have a greater tendency to move off-target, it makes sense to determine what the percentage of small droplets is for a particular spray tip to minimize it when drift is a concern. Droplets below 150 microns are considered potential drift contributors.

The table to the right shows several tips and their percentage of driftable fines.



## DRIFTABLE FINES

NOZZLE TYPE (1.89 l/min CAPACITY)	APPROXIMATE PERCENTAGE OF SPRAY VOLUME LESS THAN 150 MICRONS	
	1.5 bar	3 bar
XR – Extended Range TeeJet® (110°)	18%	29%
TTJ60 – Turbo TwinJet® (110°)	8%	14%
TT – Turbo TeeJet® (110°)	7%	16%
TF – Turbo FloodJet®	5%	9%
AIXR – Air Induction XR TeeJet® (110°)	4%	9%
AITTJ60 – Air Induction Turbo TwinJet® (110°)	2%	3%
AI – Air Induction TeeJet® (110°)	5% (@ 2 bar)	7%
TTI60 – Turbo TeeJet® Induction TwinJet® (110°)	2%	4%
TTI – Turbo TeeJet® Induction (110°)	<1%	2%
APTJ – AccuPulse® TwinJet® (110°)	<1%	1%

Data obtained from Oxford VisiSizer system, spraying water at 21°C under laboratory conditions.

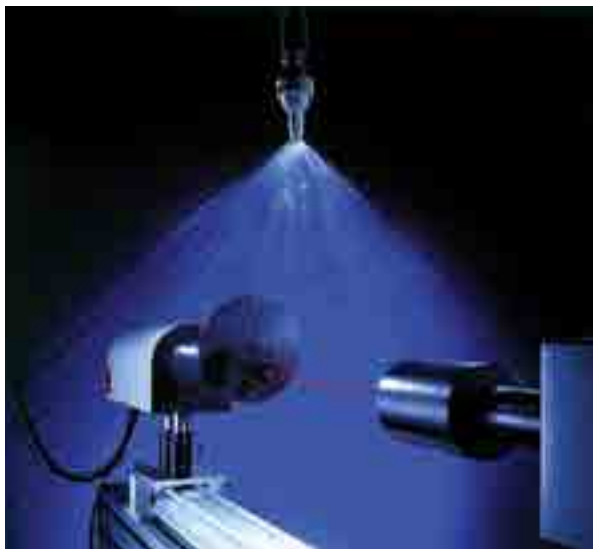



Figure 1. This is not what crop protection should look like!

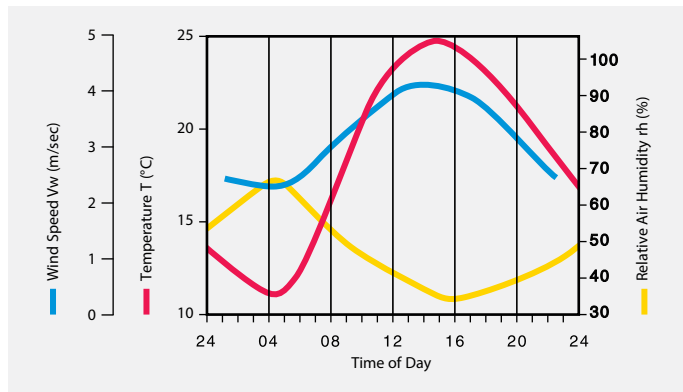

Figure 2. Development of wind speed, air temperature and relative air humidity (example). From: Malberg

When applying crop protection products, spray drift is defined as the movement and deposition of spray particles through the air to non-target locations. The two forms of spray drift are particle drift and vapor drift. Particle drift can occur during or after a crop protection product application, which results from droplets physically moving to non-target locations via air currents. It is more related to the application technology choices, such as spray tip selection and sprayer calibration. Vapor drift of the active ingredient occurs right after the crop protection product application and the crop protection product vapor reaches non-target locations. It is dependent on the crop protection product physicochemical characteristics when it has a greater trend to volatilize. Weather conditions, such as low relative humidity and high temperatures directly impact vapor drift.

The smaller the droplet, the greater the drift potential. Droplets most prone to drift are those with a diameter that is less than 150 µm and easily move off the target area by wind or other climatic conditions. Drift can cause crop protection products to be deposited in undesirable areas with serious consequences, such as:

- Damage to sensitive adjoining crops.
- Surface water contamination.
- Health risks for animals and people.
- Possible contamination to the target area and adjacent areas or possible overapplication within the target area.

## CAUSES OF SPRAY DRIFT

Several variables contribute to spray drift; these are predominantly due to the spray equipment system and meteorological factors.

### • DROPLET SIZE

Within the spray equipment system, droplet size is the most influential factor related to drift.

When a liquid solution is sprayed under pressure it is atomized into droplets of varying sizes: **The smaller the spray tip size and the greater the spray pressure, the smaller the droplets and therefore the greater the proportion of driftable droplets.**

### • SPRAY HEIGHT

As the distance between the spray tip and the target area increases, the greater impact wind speed can have on drift. The influence of wind can increase the proportion of smaller droplets being carried off target and considered drift.

Do not spray at greater heights than those recommended by the spray tip manufacturer, while taking care not to spray below the minimum recommended heights.

### • OPERATING SPEED

Increased operating speeds can cause the spray to be diverted back into upward wind currents and vortexes behind the sprayer, which traps small droplets and can contribute to drift.

**Apply crop protection products according to good, professional practices at maximum operating speeds of 9 to 13 km/h (up to 13 km/h). As wind velocities increase, reduce operating speed.\***

\* Liquid fertilizer applications using the TeeJet® tips with very coarse droplets can be performed at higher operating speeds.

### • WIND SPEED

Among the meteorological factors affecting drift, wind speed has the greatest impact. Increased wind speeds cause increased spray drift. It is common knowledge that in most parts of the world the wind speed is variable throughout the day (see Figure 2). Therefore, it is important for spraying to take place during the relatively calm hours of the day. The early

morning and early evening are usually the calmest. However, wind speed below 5 km/h can be an indicator of air instability, such as temperature inversion, resulting in drift. Ideally, winds should be in the range of 5 to 14 km/h, and crop protection products should not be sprayed when winds exceed 16 km/h. Check the product label for more information.

Wind measurements should be taken throughout the spraying operation with a wind meter or anemometer. As the risk of spray drift increases, selecting tips designed to produce coarser droplets that are less prone to drift is extremely important, such as spray tips with air induction AIXR, AITTJ60, AI, TT160, and TT1.

### • AIR TEMPERATURE AND RELATIVE HUMIDITY

Air temperature and relative humidity directly influence droplet evaporation. Finer droplets are also more vulnerable to high temperatures and low relative humidity conditions, and when compared to coarser droplets, they are less likely to reach the target.

**High temperature during the spraying application may necessitate system changes, such as tips that produce a coarser droplet or suspending spraying.**

### • CROP PROTECTION PRODUCTS AND CARRIER VOLUME

Before applying crop protection products, the applicator should read and follow all instructions provided by the manufacturer.

Since extremely low carrier volume usually necessitates the use of small tip sizes, the drift potential is increased. As high a carrier volume as practical is recommended.

## SPRAY TIPS FOR DRIFT REDUCTION

Drift potential can be minimized even when it is necessary to use small tip capacities by selecting tip types that produce larger droplets (bigger Volume Median Diameter (VMD) and a lower percentage of small droplets).

Figure 3 is an example showing VMD's produced by tips of identical flow rates (05 capacity / 1.89 l/min capacity) at the optimum pressure ranges for the individual tips. Within the presented tips, XR produces the smaller droplets followed by TTJ60/TT, AIXR, AITTJ60, AI, TTI60/TTI, and APTJ. TTI, TTI60, and APTJ tips produce the coarsest droplet size spectrum of this group and provide the maximum drift control, producing less than 2% of driftable fines.

Looking at individual spray tips, the greater the operational pressure, the smaller the formed droplet, and the greater the drift potential. Understanding this concept, it is possible to affirm that for all tips is possible to reduce drift at lower pressure and achieve better coverage at higher pressures. However, if just by reducing the operating pressure the droplet size and the percentage of driftable fines are still above the limit for a safe application, the user must select a spray tip that produces coarser droplets.

For example, a self-propelled sprayer operating with a ground speed of 16 km/h, tip spacing of 50 cm, and an application rate of 140 l/ha would need a tip with a capacity

of 1.8 l/min, which all tips presented on Figure 3 would be able to apply at 3 bar. However, the VMD increases significantly from the XR to the TTI/TTI60/APTJ, from fine to ultra coarse droplet size. For a contact fungicide application, a TTJ60 would be a good fit while an AIXR or AITTJ60 would be a better fit for an herbicide application. Therefore, for applicators to select the correct spray tip size it is necessary to consider the droplet size and spray pressure at which a crop protection product is most effective according to the label.

With this, they simply must reduce pressure and ground speed to reduce spray drift or even comply with statutory buffer zone requirements.

While the classic XR TeeJet orifice provides two functions; metering the volume flow rate and distributing and creating the droplets, all other spray tip types discussed above use a pre-orifice for metering while droplet creation and distribution take place at the exit orifice (Figure 4). Both functions and devices relate to each other with respect to geometry and spacing and interact with respect to the droplet size produced. The TT, TTJ60, AITTJ60, TTI60, and TTI tips force the liquid to change direction after it has passed the pre-orifice, forcing it into a horizontal chamber and to change direction again into the nearly vertical passage in the orifice itself. The AIXR, AI, AITTJ60, TTI60, and TTI air induction tips operate on the Venturi principle, where the pre-orifice generates a higher-velocity stream, aspirating air through the side holes. This

specific air/liquid mix creates more coarse droplets that are filled with air, depending on the crop protection product used.

APTJ is a non-air induction tip, that produced highly drift-resistant droplet due to its patent-pending recirculating design.

## SUMMARY

Successful drift management centers on sound knowledge about drift contributing factors and the use of drift control TeeJet spray tips. To strike a sound balance between successful crop protection products application and environmental protection, applicators should use approved broadcast TeeJet spray tips that are classified as drift control and operate these within the pressure ranges that ensure product effectiveness (i.e., set spray tips to 50% drift control or less).

The following list shows all the relevant factors that need to be considered, optimized, or applied to achieve effective drift control:

- Low-Drift TeeJet spray tips
- Spraying pressure and droplet size
- Application rate and tip size
- Spraying height
- Forward speed
- Wind speed
- Ambient temperature and relative humidity
- Buffer zones (or apply options that allow reducing the width of buffer strips)
- Compliance with manufacturer instructions

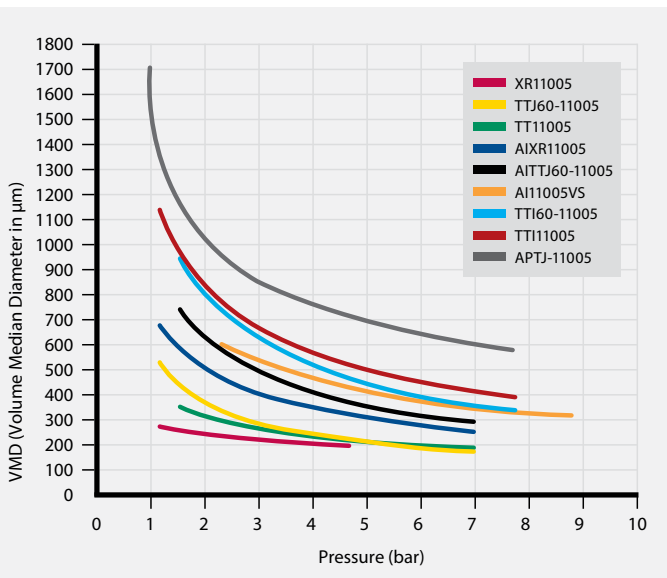

**Figure 3.** Volumetric droplet diameters of XR, TT, TTJ60, AIXR, AI, AITTJ60, TTI60, TTI, and APTJ spray tips relative to pressure.

### Measurement Conditions:

- Continuous Oxford Laser measurement across the full width of the flat spray
- Water temperature 21°C under laboratory conditions

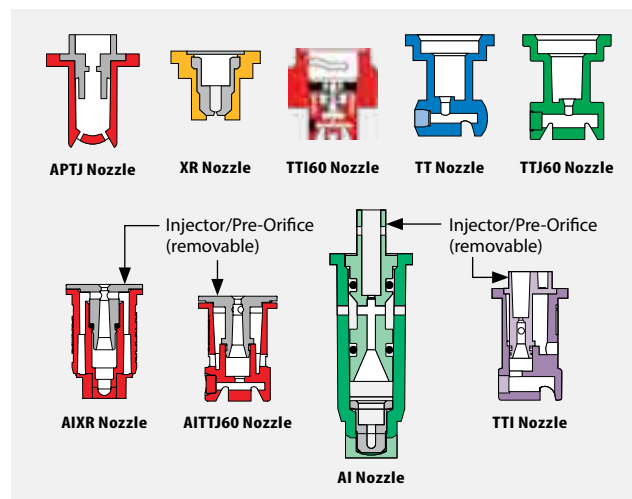

**Figure 4.** APTJ, XR, TT, TTJ60, AIXR, AITTJ60, AI, TTI60, and TTI spray tips cross-section view.

## ASSESSMENT OF NOZZLE DRIFT CONTROL IN EUROPE

In times of hard discussions regarding environmental protection, the drift control of the spray tips and spray systems became a very important topic in most of the European countries and mandatory in the Nord, West, and Middle Europe. Ones with the implementation of the European Green Deal, it's expected that the South and East parts of Europe will align at the same standards.

Drift reduction is not a new topic. Preliminary assessment criteria for drift control during by crop protection products applications were first defined in the 1980's and 1990's. With the XR TeeJet® spray tips and the first generation of drift control spray tips (DG TeeJet®), TeeJet achieved significant advances in crop protection technology at that time. However, stricter rules for buffer zones to protect sensitive areas have led to the development of a program that assesses spray tip drift reduction, as well as innovative spray tip designs (AI TeeJet) producing larger droplet sizes by maintaining perfect coverage.

The testing institutes from Germany, the United Kingdom, France, and the Netherlands have different standardized assessments for measuring drift reduction. The Julius Kühn Institute-Federal Research Institute (JKI) standards and results are accepted by most of the European countries in the national approval process.

The countries mentioned above have compiled corresponding percentage drift control categories, which vary from one to another in some areas. While in Germany and Netherlands drift control is categorized as 50% / 75% / 90% / 95%, in the United Kingdom they are categorized as 2 star\*\*, 3 star\*\*\*, and 4 star\*\*\*\*, and 66% in France. Furthermore, the same spray tip type and size operated at the same pressure can have a different category of drift reduction in different countries that use different assessments to evaluate drift control.

Drift reduction ratings are currently mandatory in some countries like Germany, Netherlands, France, Belgium, Denmark, and the United Kingdom, while in other countries the drift reduction is only a recommendation to assist farmers in selecting a tip that is more suitable for their applications.

As TeeJet Technologies is present in all European countries, all new spray tips are tested and have them assessed in each of these countries to verify the effectiveness of the technical advances so farmers can use our company products without fearing conflict with the government.

### THE SYSTEM IN GERMANY

In Germany, the Julius Kühn Institute-Federal Research Institute for Cultivated Plants (JKI), is responsible for testing nozzles for agricultural use. Drift measurements are taken for standard spray tips (110–120°, symmetric pattern, 50 cm spacing) in the wind tunnel, using vertical collectors and the "DIX model" (Drift Potential Index), which gives values that express the percentage of drift reduction categories. For narrow-angle spray tips, asymmetric or 25 cm spacing, the measurements take place in the field under standardized conditions for temperature, wind direction, wind speed, and forward speed.

### THE SYSTEM IN THE UNITED KINGDOM (UK)

The UK agency for the equipment certification is the Local Environmental Risk Assessments for Pesticides (LERAP). Spray application systems that have been tested regarding drift reduction in the SILSOE wind tunnel will get a "LERAP-Low Drift Star Rating" which are: 2 star\*\*, 3 star\*\*\*, and 4 star\*\*\*\*, which roughly corresponds to 50%, 75%, and 90% of drift reduction respectively.

In contrast to the JKI, the UK wind tunnel methodology records the droplets landed on horizontal collectors.

### THE SYSTEM IN THE NETHERLANDS

The local authority in NL for the spray equipment approvals is the Technical Assessment Committee (TCT), and the results of spray tips that reduce drift by 50%, 75%, 90%, and 95% are published on the DRD list. Instead of using wind tunnel systems as used at JKI and LERAP, the Wageningen University (WUR) uses a Phase Doppler Particle Analyzer (PDPA laser) to investigate droplet velocity and some parameters such as  $DV_{0,1}$ , VMD,  $DV_{0,9}$ , and volume fraction  $<100\mu\text{m}$ . The data collected is then fed into the IDEFICS model.

### THE SYSTEM IN FRANCE

In France, the tested spray tips and spray equipment are published on the official list of the Ministry of Agriculture and Food, after consulting the National Research Institute for Agriculture, Food and the Environment (INRAE). Up to now, the drift reduction requirement is 66% for applications that take place close to sensitive areas.

### BENEFITS & OPTIONS FOR USERS

The use of low drift spray tips brings significant benefits to users around the world. Depending on the location of the fields from environmentally sensitive areas such as surface water and field boundaries, applicators can reduce the width of buffer zones, as stipulated by the relevant restrictions in association with the approval of the pesticide (e.g. 20-meter no-spray buffer zone) and the national legislation. In general, for successful crop protection, it is only necessary to select spray tips with a high percentage classification for drift control in those situations where statutory buffer zone requirements apply. Otherwise, it is preferable to use nozzles at a spray pressure achieving a 50% drift control or less, depending on the application.

For further information about the low-drift categories of TeeJet spray tips, contact your TeeJet representative or go to [www.teejet.com](http://www.teejet.com).



The droplet size classification follows a strict and concise parameter, which was first created in 1985 in England by the British Crop Protection Council (BCPC). This classification system established a series of droplet size classes.

In 1999, the American Society of Agricultural and Biological Engineers (ASABE) developed a new standard for droplet size classification—ASABE S572, in which the droplet size boundaries were set by a series of defined TeeJet reference spray tips and operating pressures (ASABE, 2009). The ASABE S572 original standard established six droplet size classes (VF, F, M, C, VC, and XC), with 5 reference nozzles establishing the boundaries between them. Two additional droplet size classes were added in the same year on the review of the standard—ASABE S572.1, totaling eight classes (XF, VF, F, M, C, VC, XC, and UC).

The International Organization for Standardization (ISO) worked on the development of an international droplet size classification standard and, in 2018, the ISO 25358 standard was published (ISO, 2018), which carried out the update of some droplets size classification ranges to better distribute the classification boundaries. Only the C/VC, VC/XC, and XC/UC boundaries have changed. The new droplet size data in catalog 52 are based on this new classification standard. The ASABE has updated the standard to match with the ISO 25358 as ASABE S572.3.

Spray tip type selection is often based upon droplet size. The droplet size from a tip becomes very important when the efficacy of a particular crop protection product is dependent on coverage, or the prevention of spray drift is a priority. Most of the spray tips used in agriculture produce droplet sizes in the range of very fine to ultra coarse droplets.

Spray tips that produce droplets in the fine to the medium range are usually recommended for post-emergence contact applications,









such as fungicides and insecticides, which require excellent coverage on the intended target area. Spray tips producing medium to very coarse droplets, in general, are more recommended for systemic insecticides and contact herbicides. Spray tips producing droplets from the medium to the ultra coarse provide significantly improved drift control while offering less thorough target coverage. These spray tips are commonly used for soil applied and systemic herbicides.

It is important to remember that a given spray tip produces different droplet sizes when operating at different pressures. For example, an AIXR11003 produces a very coarse droplet size at 2 bar and a medium droplet size at 4 bar.

Care must be taken when comparing the droplet size of different tips, as different droplet size standards can bias the comparison and measuring techniques.

For the latest accurate information about spray tips and their droplet size, please contact your nearest TeeJet representative.

Droplet size classes are shown in the following tables to assist in choosing an appropriate spray tip.

CATEGORY	COLOR CODE	
Extremely Fine		XF
Very Fine		VF
Fine		F
Medium		M
Coarse		C
Very Coarse		VC
Extremely Coarse		XC
Ultra Coarse		UC

Droplet size classifications are in accordance with ISO Standard 25358 at the date of printing, and its standard classification is subject to change.

## AI TEEJET® (AI EVEN)

TIP PART NO.	bar										
	2	2.5	3	3.5	4	4.5	5	5.5	6	7	8
A195015E	XC	XC	XC	VC	VC	VC	VC	VC	C	C	M
A16502E	UC	XC	XC	XC	VC	VC	VC	VC	VC	C	C
A19502E	XC	XC	XC	VC	VC	VC	VC	VC	C	C	C
A165025E	UC	XC	XC	XC	XC	VC	VC	VC	VC	VC	C
A195025E	XC	XC	XC	VC	VC	VC	VC	VC	C	C	C
A16503E	UC	XC	XC	XC	XC	VC	VC	VC	VC	C	C
A19503E	XC	XC	XC	VC	VC	VC	VC	VC	C	C	C
A16504E	UC	XC	XC	XC	VC	VC	VC	VC	C	C	C
A19504E	XC	XC	XC	VC	VC	VC	VC	VC	C	C	C
A16505E	UC	XC	XC	XC	XC	VC	VC	VC	VC	VC	VC
A19505E	XC	XC	XC	VC	VC	VC	VC	VC	C	C	C
A16506E	UC	UC	XC	XC	XC	XC	XC	VC	VC	VC	VC
A19506E	UC	XC	XC	XC	VC	VC	VC	VC	VC	C	C
A19508E	UC	XC	XC	XC	VC	VC	VC	VC	C	C	C

## AI3070 TEEJET® (AI3070)

TIP PART NO.	bar									
	1.5	2	2.5	3	3.5	4	4.5	5	5.5	6
AI3070-015	VC	VC	VC	C	C	C	C	M	M	M
AI3070-02	XC	VC	VC	C	C	C	C	M	M	M
AI3070-025	XC	VC	VC	VC	C	C	C	C	M	M
AI3070-03	XC	XC	VC	VC	VC	C	C	C	C	C
AI3070-04	XC	XC	VC	VC	VC	VC	C	C	C	C
AI3070-05	UC	XC	XC	VC	VC	VC	VC	C	C	C

## AI TEEJET® (AI)

TIP PART NO.	bar									
	2	3	4	5	5.5	6	6.5	7	8	
A180015	XC	VC	VC	VC	C	C	C	C	C	
A110015	XC	VC	VC	C	C	C	C	C	M	
A18002	XC	XC	VC	VC	VC	C	C	C	C	
A11002	XC	VC	VC	C	C	C	C	C	M	
A180025	XC	XC	VC	VC	VC	C	C	C	C	
A110025	XC	VC	VC	C	C	C	C	C	M	
A18003	XC	XC	VC	VC	VC	C	C	C	C	
A11003	XC	VC	VC	C	C	C	C	C	M	
A18004	XC	XC	VC	VC	VC	C	C	C	C	
A11004	XC	VC	VC	C	C	C	C	C	M	
A18005	XC	XC	VC	VC	VC	VC	C	C	C	
A11005	XC	XC	VC	VC	VC	C	C	C	C	
A18006	XC	XC	VC	VC	VC	VC	VC	VC	VC	
A11006	XC	XC	VC	VC	VC	C	C	C	C	
A11008	XC	XC	VC	VC	VC	VC	VC	VC	C	

## AIC TEEJET® (AIC)

TIP PART NO.	bar								
	2	3	4	5	5.5	6	6.5	7	8
AIC110015-VS	XC	XC	VC	VC	C	C	C	C	C
AIC11002-VS	XC	XC	VC	VC	C	C	C	C	C
AIC110025-VS	XC	XC	VC	VC	C	C	C	C	C
AIC11003-VS	XC	XC	VC	VC	C	C	C	C	C
AIC11004-VS	XC	XC	VC	VC	C	C	C	C	C
AIC11005-VS	XC	XC	VC	VC	VC	C	C	C	C
AIC11006-VS	XC	XC	VC	VC	VC	VC	C	C	C
AIC11008-VS	XC	XC	VC	VC	VC	VC	VC	VC	VC
AIC11010-VS	UC	XC	XC	XC	VC	VC	VC	VC	VC
AIC11015-VS	UC	XC	XC	XC	VC	VC	VC	VC	VC

## ACCUPULSE® TWINJET® (APTJ)

TIP PART NO.	bar											
	1	1.5	2	2.5	3	3.5	4	4.5	5	5.5	6	7
APTJ-110015	UC	UC	UC	UC	UC	UC	UC	XC	XC	XC	XC	XC
APTJ-11002	UC	UC	UC	UC	UC	UC	UC	XC	XC	XC	XC	XC
APTJ-110025	UC	UC	UC	UC	UC	UC	UC	XC	XC	XC	XC	XC
APTJ-11003	UC	UC	UC	UC	UC	UC	UC	XC	XC	XC	XC	XC
APTJ-11004	UC	UC	UC	UC	UC	UC	UC	XC	XC	XC	XC	XC
APTJ-11005	UC	UC	UC	UC	UC	UC	UC	XC	XC	XC	XC	XC
APTJ-11006	UC	UC	UC	UC	UC	UC	UC	XC	XC	XC	XC	XC
APTJ-11008	UC	UC	UC	UC	UC	UC	UC	XC	XC	XC	XC	XC
APTJ-11010	UC	UC	UC	UC	UC	UC	UC	XC	XC	XC	XC	XC
APTJ-11012	UC	UC	UC	UC	UC	UC	XC	XC	XC	XC	XC	XC

## AIR INDUCTION TURBO TWINJET® (AITTJ60)

TIP PART NO.	bar									
	1.5	2	2.5	3	3.5	4	4.5	5	5.5	6
AITTJ60-11002	XC	VC	VC	VC	C	C	C	C	C	M
AITTJ60-110025	XC	VC	VC	VC	VC	C	C	C	C	C
AITTJ60-11003	XC	XC	VC	VC	VC	C	C	C	C	C
AITTJ60-11004	XC	XC	VC	VC	VC	C	C	C	C	C
AITTJ60-11005	XC	XC	XC	VC	VC	VC	C	C	C	C
AITTJ60-11006	XC	XC	XC	VC	VC	VC	VC	C	C	C
AITTJ60-11008	UC	UC	XC	XC	XC	XC	VC	VC	VC	VC
AITTJ60-11010	UC	UC	XC	XC	XC	XC	VC	VC	VC	VC
AITTJ60-11015	UC	UC	XC	XC	XC	XC	VC	VC	VC	VC

## AITX CONEJET® (AITXA & AITXB)

TIP PART NO.	bar																
	4	5	6	7	8	9	10	11	12	13	14	15	16	17	18	19	20
AITX01	XC	VC	VC	VC	C	C	M	M	M	M	M	F	F	F	F	F	F
AITX015	XC	VC	VC	VC	C	C	M	M	M	M	M	F	F	F	F	F	F
AITX02	XC	VC	VC	VC	C	C	C	C	M	M	M	M	M	M	M	M	F
AITX025	XC	XC	XC	VC	VC	VC	VC	C	C	C	M	M	M	M	M	M	F
AITX03	XC	XC	XC	VC	VC	VC	VC	C	C	C	M	M	M	M	M	M	F
AITX04	UC	UC	XC	VC	VC	VC	VC	C	C	C	C	C	M	M	M	M	M

## AIUB TEEJET® (AIUB)

TIP PART NO.	bar									
	2	2.5	3	3.5	4	4.5	5	5.5	6	7
AIUB8502	UC	XC	XC	XC	VC	VC	VC	VC	C	C
AIUB85025	UC	XC	XC	VC	VC	VC	VC	C	C	C
AIUB8503	XC	XC	XC	VC	VC	VC	VC	C	C	C
AIUB8504	XC	XC	XC	VC	VC	VC	VC	C	C	C

## AIXR TEEJET® (AIXR)

TIP PART NO.	bar										
	1	1.5	2	2.5	3	3.5	4	4.5	5	5.5	6
AIXR110015	VC	VC	C	C	C	M	M	M	M	M	M
AIXR11002	XC	VC	VC	C	C	M	M	M	M	M	M
AIXR110025	XC	VC	VC	C	C	M	M	M	M	M	M
AIXR11003	XC	VC	VC	C	C	C	M	M	M	M	M
AIXR11004	XC	VC	VC	VC	C	C	C	M	M	M	M
AIXR11005	XC	XC	VC	VC	VC	C	C	C	M	M	M
AIXR11006	XC	XC	VC	VC	VC	VC	C	C	C	C	C
AIXR11008	UC	XC	XC	XC	VC	VC	VC	VC	C	C	C
AIXR11010	UC	XC	XC	XC	VC	VC	VC	VC	VC	VC	VC

## DG TEEJET® (DG)

TIP PART NO.	bar				
	2	2.5	3	3.5	4
DG80015	M	M	F	F	F
DG110015	M	M	M	M	F
DG8002	C	M	M	M	M
DG11002	C	C	M	M	M
DG8003	C	M	M	M	M
DG11003	C	C	M	M	M
DG8004	C	M	M	M	M
DG11004	C	C	M	M	M
DG8005	C	C	M	M	M
DG11005	C	C	C	M	M



## DROPLET SIZE CLASSIFICATION

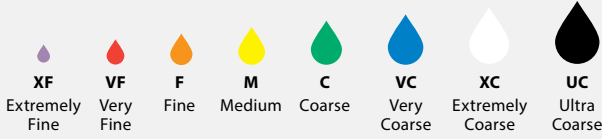

### DG TEEJET® (DG E)

TIP PART NO.	bar			
	2	3	3.5	4
DG95015E	M	F	F	F
DG9502E	M	M	M	M
DG9503E	M	M	M	M
DG9504E	C	M	M	M
DG9505E	C	C	M	M

### DG TWINJET® (DGTJ60)

TIP PART NO.	bar				
	2	2.5	3	3.5	4
DGTJ60-110015	M	M	F	F	F
DGTJ60-11002	M	M	M	M	M
DGTJ60-11003	M	M	M	M	M
DGTJ60-11004	C	C	C	M	M
DGTJ60-11006	C	C	C	M	M
DGTJ60-11008	C	C	C	M	M

### TEEJET® (TP)

TIP PART NO.	bar				
	2	2.5	3	3.5	4
TP80005	F	F	VF	VF	VF
TP110005	VF	VF	VF	VF	VF
TP800067	F	F	F	VF	VF
TP1100067	F	VF	VF	VF	VF
TP8001	F	F	F	F	VF
TP11001	F	F	F	VF	VF
TP80015	F	F	F	F	F
TP110015	F	F	F	F	F
TP8002	M	F	F	F	F
TP11002	F	F	F	F	F
TP8003	M	M	M	F	F
TP11003	M	F	F	F	F
TP8004	M	M	M	M	M
TP11004	M	F	F	F	F
TP8005	M	M	M	M	M
TP11005	M	M	M	M	M
TP8006	C	M	M	M	M
TP11006	M	M	M	M	M
TP8008	C	C	M	M	M
TP11008	M	M	M	M	M
TP8010	C	C	M	M	M
TP11010	C	M	M	M	M
TP8015	VC	C	C	C	C
TP11015	C	C	C	M	M
TP8020	VC	C	C	C	C
TP11020	VC	C	C	C	C

### TEEJET (TP E)

TIP PART NO.	bar				
	2	2.5	3	3.5	4
TP8001E	F	F	F	F	VF
TP80015E	F	F	F	F	F
TP8002E	M	F	F	F	F
TP8003E	M	M	F	F	F
TP8004E	M	M	M	M	F
TP8005E	M	M	M	M	M
TP8006E	C	M	M	M	M
TP8008E	C	C	M	M	M
TP8010E	C	C	C	M	M
TP8015E	VC	C	C	C	C
TP8020E	VC	VC	VC	C	C

### TK FLOODJET® (TK)

TIP PART NO.	bar											
	1	1.5	2	2.5	3	3.5	4	4.5	5	5.5	6	7
TK-1	M	M	M	F	F	F	F	F	F	F	F	F
TK-1.5	M	M	M	M	F	F	F	F	F	F	F	F
TK-2	M	M	M	M	M	F	F	F	F	F	F	F
TK-2.5	M	M	M	M	M	M	M	M	F	F	F	F
TK-3	C	M	M	M	M	M	M	M	M	M	M	M
TK-4	C	M	M	M	M	M	M	M	M	M	M	M
TK-5	C	C	C	M	M	M	M	M	M	M	M	M
TK-7.5	VC	C	C	C	M	M	M	M	M	M	M	M
TK-10	VC	VC	C	C	C	C	C	M	M	M	M	M

### TURBO TEEJET® (TT)

TIP PART NO.	bar										
	1	1.5	2	2.5	3	3.5	4	4.5	5	5.5	6
TT11001	VC	C	C	M	M	M	M	F	F	F	F
TT110015	VC	VC	C	C	M	M	M	M	M	F	F
TT11002	VC	VC	C	C	M	M	M	M	M	F	F
TT110025	VC	VC	C	C	M	M	M	M	M	F	F
TT11003	XC	VC	C	C	M	M	M	M	M	F	F
TT11004	XC	VC	C	C	M	M	M	M	M	F	F
TT11005	XC	VC	C	C	M	M	M	M	M	F	F
TT11006	XC	VC	C	C	M	M	M	M	M	F	F
TT11008	XC	VC	VC	C	M	M	M	M	M	M	F
TT11010	UC	XC	XC	VC	VC	VC	C	C	C	M	M
TT11012	UC	XC	XC	VC	VC	VC	VC	VC	C	C	C

## TURBO TEEJET® INDUCTION (TTI)

TIP PART NO.	bar									
	1.0	1.5	2.5	3.5	4.0	4.5	5.0	5.5	6.0	7.0
TTI11001	UC	UC	XC	XC	VC	VC	VC	VC	VC	C
TTI110015	UC	UC	UC	XC	XC	XC	VC	VC	VC	VC
TTI11002	UC	UC	UC	XC	XC	XC	VC	VC	VC	VC
TTI110025	UC	UC	UC	XC	XC	XC	VC	VC	VC	VC
TTI11003	UC	UC	UC	XC	XC	VC	VC	VC	VC	VC
TTI11004	UC	UC	UC	XC	XC	VC	VC	VC	VC	VC
TTI11005	UC	UC	UC	XC	XC	VC	VC	VC	VC	VC
TTI11006	UC	UC	UC	XC	XC	VC	VC	VC	VC	C
TTI11008	UC	UC	UC	XC	XC	VC	VC	VC	VC	C
TTI11010	UC	UC	UC	XC	XC	VC	VC	VC	VC	C

## TTI TWINJET® (TTI60)

TIP PART NO.	bar										
	1.5	2	2.5	3	3.5	4	4.5	5	5.5	6	7
TTI60-11002	XC	XC	XC	VC	VC	VC	VC	C	C	C	C
TTI60-110025	XC	XC	XC	VC	VC	VC	VC	C	C	C	C
TTI60-11003	UC	UC	XC	XC	XC	VC	VC	VC	VC	VC	C
TTI60-11004	UC	UC	XC	XC	XC	VC	VC	VC	VC	VC	C
TTI60-11005	UC	UC	XC	XC	XC	VC	VC	VC	VC	VC	C
TTI60-11006	UC	UC	XC	XC	XC	VC	VC	VC	VC	VC	C
TTI60-11008	UC	UC	UC	XC	XC	XC	VC	VC	VC	VC	C

## TURFJET (TTJ)

TIP PART NO.	bar								
	1.5	2	2.5	3	3.5	4	4.5	5	5
1/4TTJ02	UC	XC	XC	XC	VC	VC	VC	VC	VC
1/4TTJ04	UC	UC	UC	UC	UC	UC	UC	UC	UC
1/4TTJ05	UC	UC	UC	UC	UC	UC	UC	UC	UC
1/4TTJ06	UC	UC	UC	UC	UC	UC	UC	UC	UC
1/4TTJ08	UC	UC	UC	UC	UC	UC	UC	UC	UC
1/4TTJ10	UC	UC	UC	UC	UC	UC	UC	UC	UC
1/4TTJ15	UC	UC	UC	UC	UC	UC	UC	UC	UC

## TURBO TWINJET® (TTJ60)

TIP PART NO.	bar									
	1.5	2	2.5	3	3.5	4	4.5	5	5.5	6
TTJ60-11002	C	C	M	M	M	M	M	M	M	M
TTJ60-110025	VC	C	C	C	M	M	M	M	M	M
TTJ60-11003	VC	C	C	C	M	M	M	M	M	M
TTJ60-11004	VC	C	C	C	M	M	M	M	M	M
TTJ60-11005	VC	C	C	C	M	M	M	M	M	M
TTJ60-11006	VC	C	C	C	M	M	M	M	M	M
TTJ60-11008	VC	C	C	C	M	M	M	M	M	M
TTJ60-110010	VC	VC	C	C	M	M	M	M	M	M

## TURBO FLOODJET® (TF-VP)

TIP PART NO.	bar									
	1	1.5	2	2.5	3	3.5	4	4.5	5	
TF-VP2	XC	XC	VC	VC	C	C	C	M	M	
TF-VP2.5	XC	XC	VC	VC	C	C	C	M	M	
TF-VP3	XC	XC	VC	VC	VC	C	C	C	M	
TF-VP4	UC	XC	XC	VC	VC	VC	VC	C	C	
TF-VP5	UC	XC	XC	VC	VC	VC	VC	C	C	
TF-VP7.5	UC	XC	XC	VC	VC	VC	VC	C	C	
TF-VP10	UC	XC	XC	VC	VC	VC	VC	C	C	

## TURBO FLOODJET (TF-VS)

TIP PART NO.	bar									
	1	1.5	2	2.5	3	3.5	4	4.5	5	
TF-VS2	UC	UC	XC	VC	VC	VC	VC	C	C	
TF-VS2.5	UC	UC	XC	VC	VC	VC	VC	C	C	
TF-VS3	UC	UC	XC	XC	VC	VC	VC	C	C	
TF-VS4	UC	UC	XC	XC	VC	VC	VC	C	C	
TF-VS5	UC	UC	XC	XC	VC	VC	VC	C	C	
TF-VS7.5	UC	UC	XC	XC	VC	VC	VC	C	C	
TF-VS10	UC	UC	XC	XC	VC	VC	VC	C	C	

## TX CONEJET® (TX)

TIP PART NO.	bar									
	2	2.5	3	3.5	4	4.5	5	5.5	6	7
TX-1	VF	VF	VF	VF	VF	VF	VF	VF	VF	VF
TX-2	VF	VF	VF	VF	VF	VF	VF	VF	VF	VF
TX-3	VF	VF	VF	VF	VF	VF	VF	VF	VF	VF
TX-4	VF	VF	VF	VF	VF	VF	VF	VF	VF	VF
TX-6	VF	VF	VF	VF	VF	VF	VF	VF	VF	VF
TX-8	VF	VF	VF	VF	VF	VF	VF	VF	VF	VF
TX-10	VF	VF	VF	VF	VF	VF	VF	VF	VF	VF
TX-12	VF	VF	VF	VF	VF	VF	VF	VF	VF	VF
TX-18	VF	VF	VF	VF	VF	VF	VF	VF	VF	VF
TX-26	F	VF	VF	VF	VF	VF	VF	VF	VF	VF

## TX CONEJET® (TXA & TXB)

TIP PART NO.	bar									
	2	2.5	3	3.5	4	4.5	5	5.5	6	7
TX*800050	VF	VF	VF	VF	VF	VF	VF	VF	VF	VF
TX*800067	VF	VF	VF	VF	VF	VF	VF	VF	VF	VF
TX*8001	VF	VF	VF	VF	VF	VF	VF	VF	VF	VF
TX*80015	VF	VF	VF	VF	VF	VF	VF	VF	VF	VF
TX*80020	VF	VF	VF	VF	VF	VF	VF	VF	VF	VF
TX*80030	VF	VF	VF	VF	VF	VF	VF	VF	VF	VF
TX*8004	F	VF	VF	VF	VF	VF	VF	VF	VF	VF

\*- Specify A or B

## DROPLET SIZE CLASSIFICATION

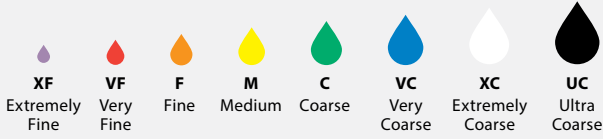

### TXR CONEJET® (TXR)

TIP PART NO.	bar									
	2	2.5	3	3.5	4	4.5	5	5.5	6	7
TXR8000553	VF	VF	VF	VF	VF	VF	VF	VF	VF	VF
TXR800071	VF	VF	VF	VF	VF	VF	VF	VF	VF	VF
TXR8001	VF	VF	VF	VF	VF	VF	VF	VF	VF	VF
TXR80013	VF	VF	VF	VF	VF	VF	VF	VF	VF	VF
TXR80015	VF	VF	VF	VF	VF	VF	VF	VF	VF	VF
TXR80017	VF	VF	VF	VF	VF	VF	VF	VF	VF	VF
TXR80020	VF	VF	VF	VF	VF	VF	VF	VF	VF	VF
TXR80028	VF	VF	VF	VF	VF	VF	VF	VF	VF	VF
TXR80030	VF	VF	VF	VF	VF	VF	VF	VF	VF	VF
TXR80036	VF	VF	VF	VF	VF	VF	VF	VF	VF	VF
TXR8004	F	VF	VF	VF	VF	VF	VF	VF	VF	VF
TXR80049	F	F	VF	VF	VF	VF	VF	VF	VF	VF

### TWINJET® (TJ60)

TIP PART NO.	bar				
	2	2.5	3	3.5	4
TJ60-8001	F	F	VF	VF	VF
TJ60-8002	F	F	F	F	F
TJ60-11002	F	F	F	F	F
TJ60-8003	F	F	F	F	F
TJ60-11003	F	F	F	F	F
TJ60-8004	F	F	F	F	F
TJ60-11004	F	F	F	F	F
TJ60-8005	M	M	M	F	F
TJ60-11005	M	M	M	F	F
TJ60-8006	M	M	M	M	M
TJ60-11006	M	M	M	M	M
TJ60-8008	M	M	M	M	M
TJ60-11008	M	M	M	M	M
TJ60-8010	M	M	M	M	M
TJ60-11010	M	M	M	M	M

### XR TEEJET® (XR)

TIP PART NO.	bar							
	1	1.5	2	2.5	3	3.5	4	
XR8001	F	F	F	F	F	F	F	
XR11001	F	F	F	F	F	F	VF	
XR80015	M	F	F	F	F	F	F	
XR110015	M	F	F	F	F	F	F	
XR8002	M	M	F	F	F	F	F	
XR11002	M	M	F	F	F	F	F	
XR80025	M	M	M	F	F	F	F	
XR110025	M	M	M	F	F	F	F	
XR8003	M	M	M	M	F	F	F	
XR11003	M	M	M	M	F	F	F	
XR80035	M	M	M	M	M	F	F	
XR8004	M	M	M	M	M	F	F	
XR11004	M	M	M	M	M	F	F	
XR8005	C	M	M	M	M	M	F	
XR11005	M	M	M	M	M	F	F	
XR8006	C	C	M	M	M	M	M	
XR11006	C	C	M	M	M	M	M	
XR8008	VC	C	C	M	M	M	M	
XR11008	C	M	M	M	M	M	M	
XR8010	VC	C	C	C	M	M	M	
XR11010	C	C	C	M	M	M	M	
XR8015	XC	VC	VC	C	C	C	M	
XR11015	VC	VC	C	C	C	C	M	
XR11020	XC	VC	VC	VC	C	C	C	

### TWINJET® (TJ60 E)

TIP PART NO.	bar				
	2	2.5	3	3.5	4
TJ60-8002E	F	F	F	F	F
TJ60-8003E	F	F	F	F	F
TJ60-8004E	F	F	F	F	F
TJ60-8006E	M	M	M	F	F

### XRC TEEJET® (XRC)

TIP PART NO.	bar						
	1	1.5	2	2.5	3	3.5	4
XRC8001	F	F	F	F	F	F	F
XRC11001	F	F	F	F	F	F	VF
XRC80015	M	F	F	F	F	F	F
XRC110015	M	F	F	F	F	F	F
XRC8002	M	M	F	F	F	F	F
XRC11002	M	M	F	F	F	F	F
XRC80025	M	M	M	F	F	F	F
XRC110025	M	M	M	F	F	F	F
XRC8003	M	M	M	M	F	F	F
XRC11003	M	M	M	M	F	F	F
XRC80035	M	M	M	M	M	F	F
XRC8004	M	M	M	M	M	F	F
XRC11004	M	M	M	M	M	F	F
XRC8005	C	M	M	M	M	M	F
XRC11005	M	M	M	M	M	F	F
XRC8006	C	C	M	M	M	M	M
XRC11006	C	M	M	M	M	M	M
XRC8008	VC	C	C	M	M	M	M
XRC11008	C	M	M	M	M	M	M
XRC8010	VC	C	C	C	M	M	M
XRC11010	C	C	C	M	M	M	M
XRC8015	XC	VC	VC	C	C	C	M
XRC11015	VC	VC	C	C	C	C	M
XRC11020	XC	VC	VC	VC	C	C	C

### XE TEEJET® (XE)

TIP PART NO.	bar					
	0.5	1	1.5	2	3	4
XE15002	UC	UC	UC	XC	VC	VC
XE15004	UC	UC	UC	XC	VC	VC
XE15006	UC	UC	UC	XC	VC	C
XE15008	UC	UC	UC	XC	VC	C

### XP BOOMJET® (XP)

TIP PART NO.	bar				
	1.5	2	3	3.5	4
1/4XP10*	UC	UC	XC	XC	XC
1/4XP20*	UC	UC	XC	XC	XC
1/4XP25*	UC	UC	UC	XC	XC
1/2XP40*	UC	UC	UC	UC	UC
1/2XP80*	UC	UC	UC	UC	UC

\*Specify L or R

The following diagrams have been developed to serve as a guideline for plumbing agricultural sprayers. Similar manual valves may be substituted for electric valves. However, the sequence in which these valves occur should remain the same. Note that one of the most common causes of premature valve failure is improper installation.

**POSITIVE DISPLACEMENT PUMP**

Piston, roller and diaphragm pumps are all types of positive displacement pumps. This means that pump output is proportional to speed and virtually independent of pressure. A key component in a positive displacement system is the pressure relief valve. Proper placement and sizing of the pressure relief valve is essential for safe and accurate operation of a positive displacement pump.

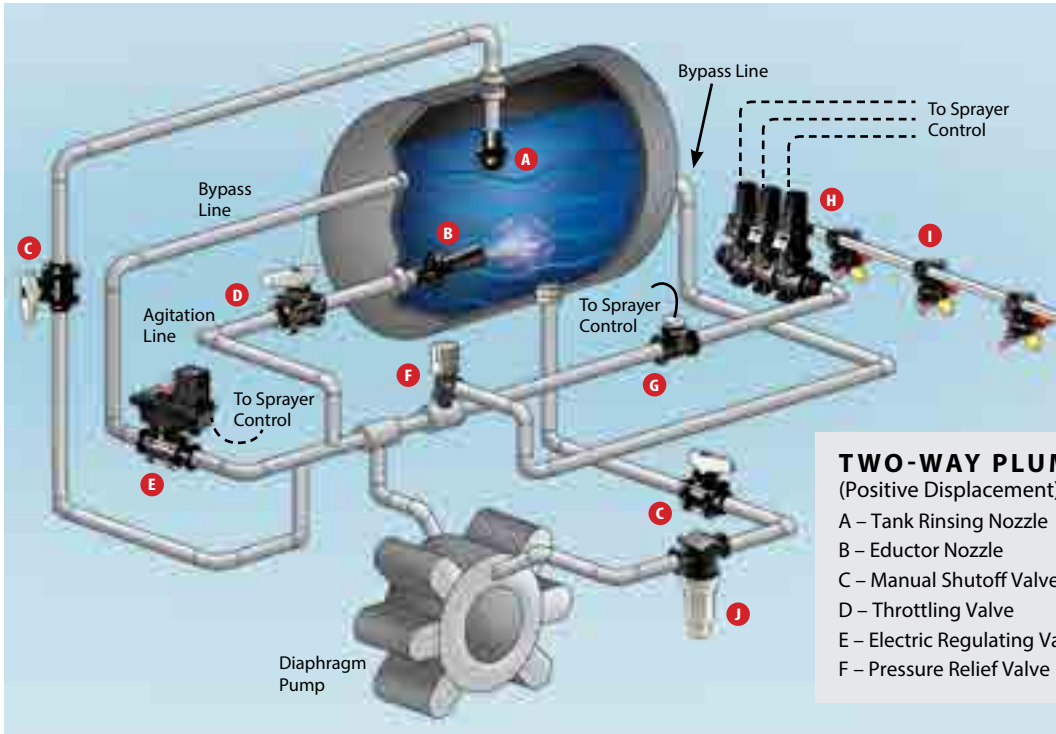

**TWO-WAY PLUMBING DIAGRAM**

(Positive Displacement)

- A – Tank Rinsing Nozzle
- B – Eductor Nozzle
- C – Manual Shutoff Valve
- D – Throttling Valve
- E – Electric Regulating Valve
- F – Pressure Relief Valve
- G – Flowmeter
- H – 2-Way Boom Control Manifold
- I – Nozzle Bodies & Spray Tips
- J – Line Strainer

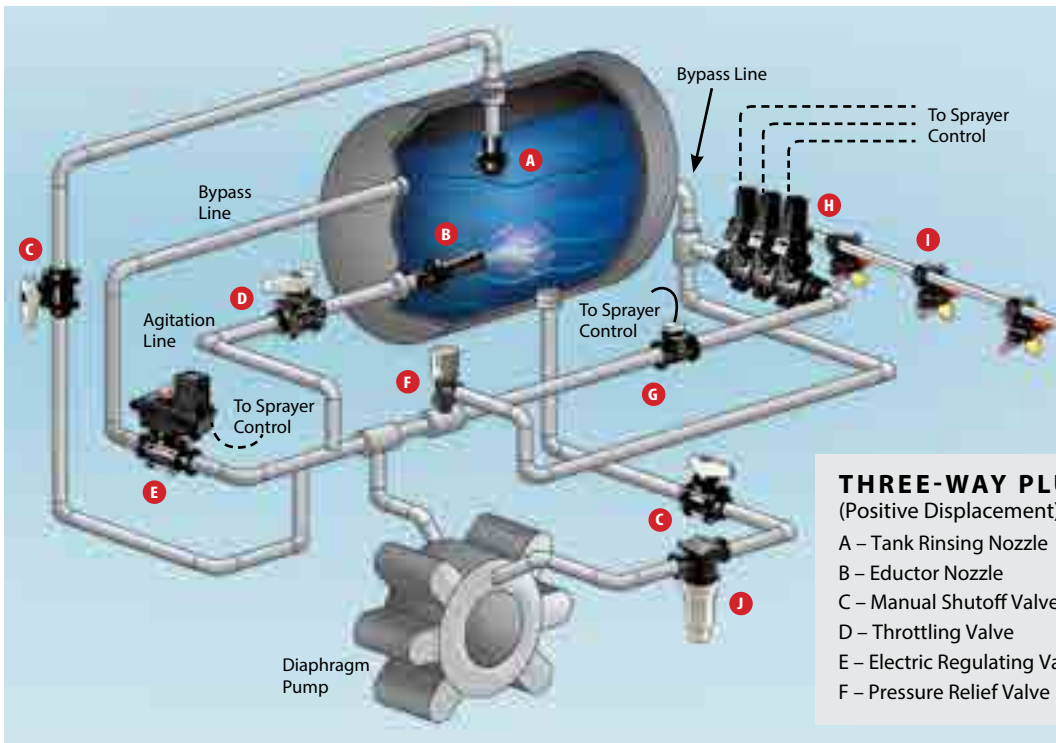

**THREE-WAY PLUMBING DIAGRAM**

(Positive Displacement)

- A – Tank Rinsing Nozzle
- B – Eductor Nozzle
- C – Manual Shutoff Valve
- D – Throttling Valve
- E – Electric Regulating Valve
- F – Pressure Relief Valve
- G – Flowmeter
- H – 3-Way Boom Control Manifold
- I – Nozzle Bodies & Spray Tips
- J – Line Strainer

**NON-POSITIVE DISPLACEMENT PUMP**

The centrifugal pump is the most common non-positive displacement pump. The output from this type of pump is influenced by pressure. This pump is ideal for delivering large volumes of liquid

at low pressures. A key component of the centrifugal pump is the throttling valve. A manual throttling valve on the main output line is essential for the accurate operation of the centrifugal pump.

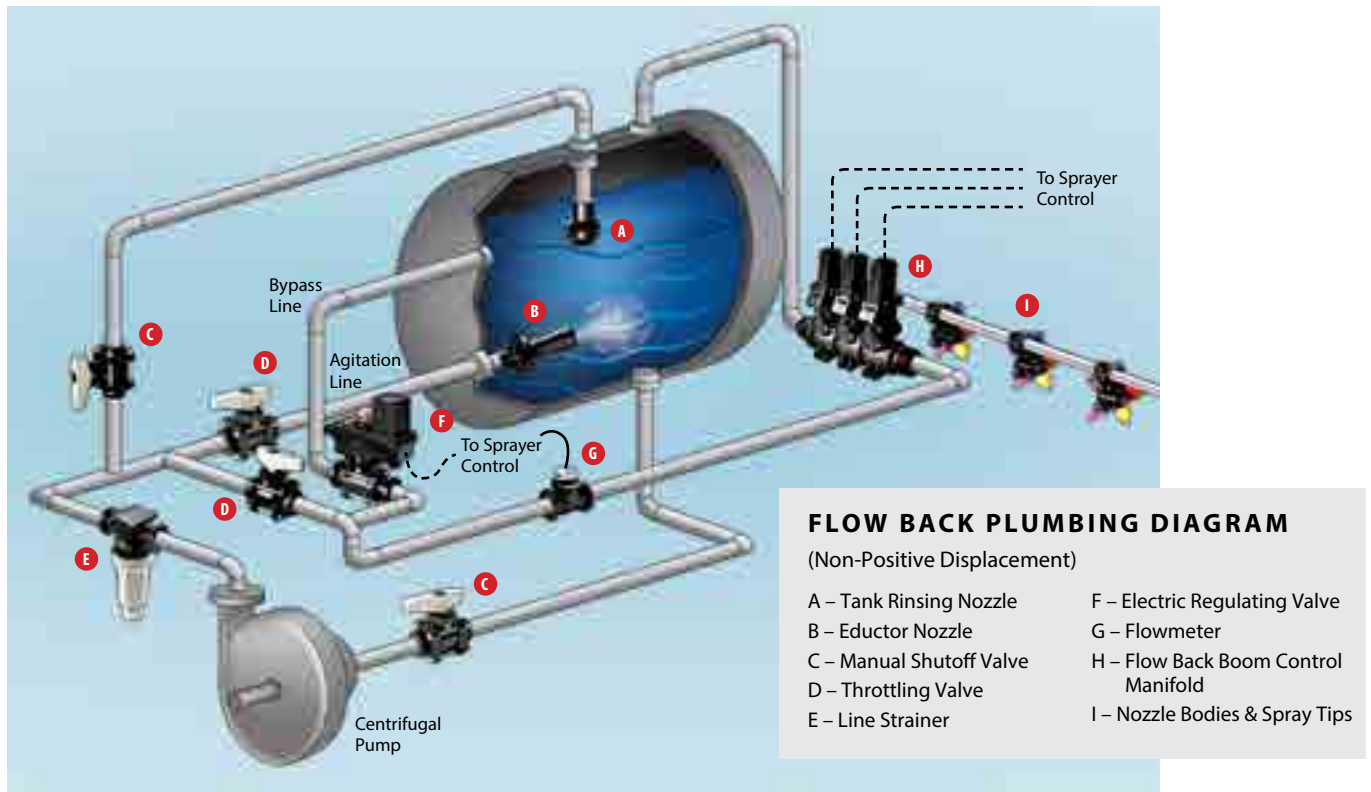
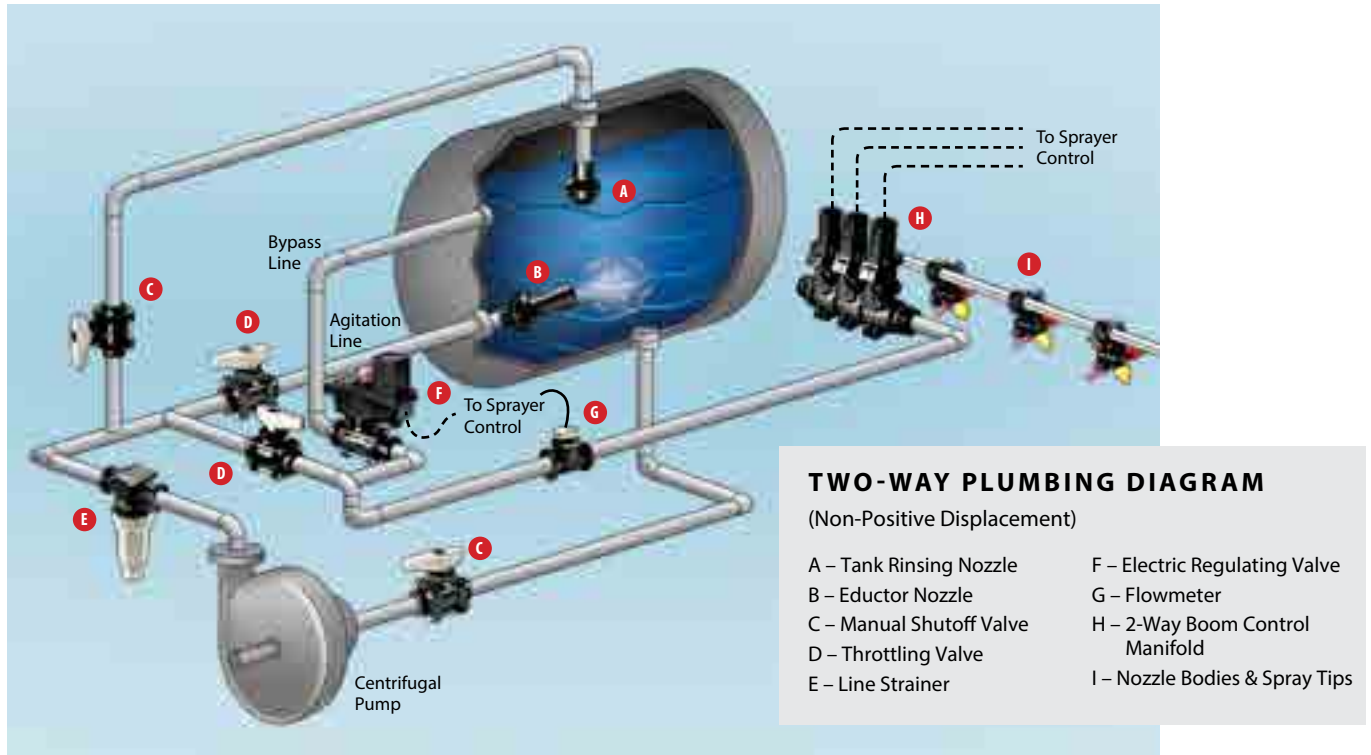

TECHNICAL INFORMATION



A small percentage of the items shown in this catalog may not be produced under an ISO registered system. For further information contact your sales representative.

## (1) MODIFICATION OF TERMS

Seller's acceptance of any order is expressly subject to Buyer's assent to each and all of the terms and conditions set forth below and Buyer's assent to these terms and conditions shall be conclusively presumed from Buyer's receipt of this document without prompt written objection thereto or from Buyer's acceptance of all or any part of goods ordered. No addition to or modification of said terms and conditions shall be binding upon Seller unless specifically agreed to by Seller in writing. If Buyer's purchase order or other correspondence contains terms or conditions contrary to or in addition to the terms and conditions set forth below, acceptance of any order by Seller shall not be construed as assent to such contrary or additional terms and conditions or constitute a waiver by Seller of any of the terms and conditions.

## (2) PRICE

Unless otherwise specified: (a) all prices, quotations, shipments and deliveries by Seller are (i) EXW (Incoterms® 2010) if shipped to the Buyer within the United States, and (2) in all other circumstances DAP Buyer's location (Incoterms® 2010); (b) all base prices together with related extras and deductions, are subject to Seller's price in effect at the time of shipment; and (c) notwithstanding the use of the shipping term DAP and without any effect on the point at which the risk of loss shifts from Seller to Buyer, all transportation, import costs and other related charges are for the account of Buyer, including all increases or decreases in such charges prior to shipment. Payment of said price shall be due at the remittance address shown on the Seller's invoice upon receipt of Seller's invoice unless otherwise specified. Interest will be charged at a rate of 1 to 11/2% per month on all balances outstanding more than 30 days after the date of the invoice. Price includes Seller's standard packaging. Special packaging requirements shall be quoted at an additional price.

## (3) UNIFORM COMMERCIAL CODE

THIS IS A CONTRACT FOR THE SALE OF GOODS. SELLER AND BUYER EXPRESSLY AGREE THAT ANY SERVICES PROVIDED PURSUANT TO THIS CONTRACT ARE MERELY INCIDENTAL TO THE SALE OF GOODS, AND AS SUCH, SHALL BE DEEMED GOODS UNDER ARTICLE 2 OF THE UNIFORM COMMERCIAL CODE. SELLER AND BUYER FURTHER AGREE THAT ANY DISPUTES ARISING FROM THIS CONTRACT SHALL BE GOVERNED BY ARTICLE 2 OF THE UNIFORM COMMERCIAL CODE.

## (4) MINIMUM BILLING

Contact your regional office representative for any minimum order requirements.

## (5) WARRANTIES

Seller warrants that its products will substantially conform to and perform in accordance with the products' specifications. Seller warrants that the products do not infringe upon any copyright, patent, or trademark. THE FOREGOING WARRANTIES ARE IN LIEU OF ALL OTHER WARRANTIES, EXPRESSED OR IMPLIED, INCLUDING, BUT NOT LIMITED TO, THOSE CONCERNING MERCHANTABILITY AND FITNESS FOR A PARTICULAR PURPOSE.

## (6) LIMITATION OF REMEDIES

Buyer's remedies under this warranty shall be limited to the replacement, repair, or refund of the purchase price for any defective product at the Seller's option. Products claimed to be defective and for which repair or replacement is desired shall be, if requested by the Seller, returned transportation prepaid to Seller's plant for inspection. Results of ordinary wear and tear, improper operation, or maintenance or use of

corrosive or abrasive materials shall not be considered a defect in material or workmanship. Any component part manufactured by another is not covered by Seller's warranty, but only by such warranty as its manufacturer gives. Because of the difficulty of asserting and measuring damages hereunder, it is agreed that, except for claims for bodily injury, Seller's liability to the Buyer or any third party, for any losses or damages, whether direct or otherwise, arising out of the purchase of product from Seller by Buyer shall not exceed the total amount billed and billable to the Buyer for the product hereunder. IN NO EVENT WILL SELLER BE LIABLE FOR ANY LOSS OF PROFITS OR OTHER SPECIAL OR CONSEQUENTIAL DAMAGES, EVEN IF SELLER HAS BEEN ADVISED OF THE POSSIBILITY OF SUCH DAMAGES.

## (7) QUALITY ASSURANCE

Seller shall have no obligation to ensure that any goods purchased from Seller meet any special Buyer quality assurance specifications and/or other special Buyer requirements unless such specifications and/or other requirements are specifically set forth in Buyer's purchase order and expressly accepted by Seller. In the event that any such goods supplied by Seller in connection therewith, are applied to an end use without the appropriate specification and/or other requirement therefore having been set forth in Buyer's purchase order and expressly accepted by Seller, Buyer shall indemnify and hold Seller harmless against any and all damages or claims for damages made by any person for any injury, fatal or nonfatal, to any person or for any damage to the property of any person incident to or arising out of such application.

## (8) CLAIMS

Claims respecting the condition of goods, compliance with specifications or any other matter affecting goods shipped to Buyer must be made promptly and, unless otherwise agreed to in writing by Seller, in no event later than one (1) year after receipt of the goods by Buyer. In no event shall any goods be returned, reworked or scrapped by Buyer without the express written authorization of Seller.

## (9) DEFAULT IN PAYMENT

If Buyer fails to make payments on any contract between Buyer and Seller in accordance with Seller's terms, Seller, in addition to any other remedies available to it, may at its option, (i) defer further shipments until such payments are made and satisfactory credit arrangements are reestablished or (ii) cancel the unshipped balance of any order.

## (10) TECHNICAL ASSISTANCE

Unless otherwise expressly stated by Seller, (a) any technical advice provided by Seller with respect to the use of goods furnished to Buyer shall be without charge; (b) Buyer shall have sole responsibility for selection and specification of the goods appropriate for the end use of such goods.

## (11) SAFETY PRECAUTIONS

Buyer shall require its employees to use all safety devices, and proper safe operation procedures as set forth in manuals and instruction sheets furnished by Seller. Buyer shall not remove or modify any such device or warning sign. It is the Buyer's responsibility to provide all means that may be necessary to effectively protect all employees from serious bodily injury which otherwise may result from the method of particular use, operation, set up or service of the goods. The operator's or machine manual, ANSI safety standards, OSHA regulations and other sources should be consulted. If Buyer fails to comply with provisions of this paragraph or the applicable standards and regulations aforementioned, and a person is injured as a result thereof, Buyer agrees to indemnify and save Seller harmless from any liability or obligation incurred by Seller.

## (12) CANCELLATION

Orders for goods specifically manufactured for Buyer cannot be canceled or modified by Buyer, and releases cannot be held up by Buyer, after such goods are in process except with the express written consent of Seller and subject to conditions then to be agreed upon which shall include, without limitation, protection of Seller against all loss.

## (13) PATENTS

The Seller shall not be liable for any costs or damages incurred by the Buyer as a result of any suit or proceeding brought against Buyer so far as based on claims (a) that use of any product, or any part thereof furnished hereunder, in combination with products not supplied by the Seller or (b) that a manufacturing or other process utilizing any product, or any part thereof furnished hereunder, constitute knowing and willful infringement of patents or trademarks arising from compliance with Buyer's designs or specifications or instructions.

## (14) COMPLETE AGREEMENT

THIS CONTRACT SETS FORTH THE ENTIRE AGREEMENT AND UNDERSTANDING OF THE PARTIES RELATING TO THE SUBJECT MATTER HEREOF, AND SUPERSEDES ALL PRIOR AGREEMENTS, DISCUSSIONS AND UNDERSTANDINGS BETWEEN THEM WHETHER ORAL OR WRITTEN, RELATING TO THE SUBJECT MATTER HEREOF.

## (15) GOVERNING LAW

All orders are accepted by Seller at its mailing address in Wheaton, Illinois, and shall be governed by and interpreted in accordance with the laws of the State of Illinois. The United Nations Convention on Contracts for the International Sale of Goods of April 11, 1980 shall be excluded.

## (16) FORCE MAJEURE

Neither party shall be in default of its obligations to the other party for any period of Force Majeure. "Force Majeure" shall mean any delay or failure of a party to perform its obligations to the other party due to causes beyond its control and without its fault or negligence. This shall include, without limitation, Acts of God, strike, civil commotion, acts of government, and any other comparable, non-foreseeable, and a serious event.

## (17) CONFIDENTIAL INFORMATION

Buyer shall maintain Confidential Information in confidence using the same care as used for its own Confidential Information. Buyer shall not disclose or divulge any Confidential Information received by it from Seller in connection with any products or services supplied by Seller to Buyer or to a third party without prior written consent of Seller, and Buyer may not use any Confidential Information for any purpose other than for the manufacture, sale and maintenance of Buyer's products. For the purposes hereof, "Confidential Information" includes any and all information and data, including, but not limited to, any business, commercial, intellectual property, technical information and data disclosed by Seller to Buyer in connection with the sale of Seller's products to Buyer, or relating to Seller's business relationship or the definition, development, marketing, selling, manufacture or distribution of Seller's products, whether disclosed orally, in writing or electronically, and irrespective of the medium in which such information or data is embedded, whether in tangible form or contained in an intangible storage medium. Confidential Information shall include any copies or abstracts made thereof, as well as any product, apparatus, modules, samples, prototypes or parts thereof.





**WHEATON FACILITY**

P.O. BOX 7900  
WHEATON, ILLINOIS  
60187-7901 USA

**SPRINGFIELD FACILITY**

1801 BUSINESS PARK DRIVE  
SPRINGFIELD, ILLINOIS  
62703 USA

**AABYBRO FACILITY**

MØLHAVEVEJ 2  
DK 9440 AABYBRO  
DENMARK



**TEEJET.COM**



All rights reserved. Full Protection of law claimed under Universal Copyright and Berne Conventions and other applicable national and international laws.

Printed in U.S.A. © Copyright 2023 TeeJet Technologies

LI52-M-R1