

# BOOMPILOT® JOB COMPUTER USER MANUAL

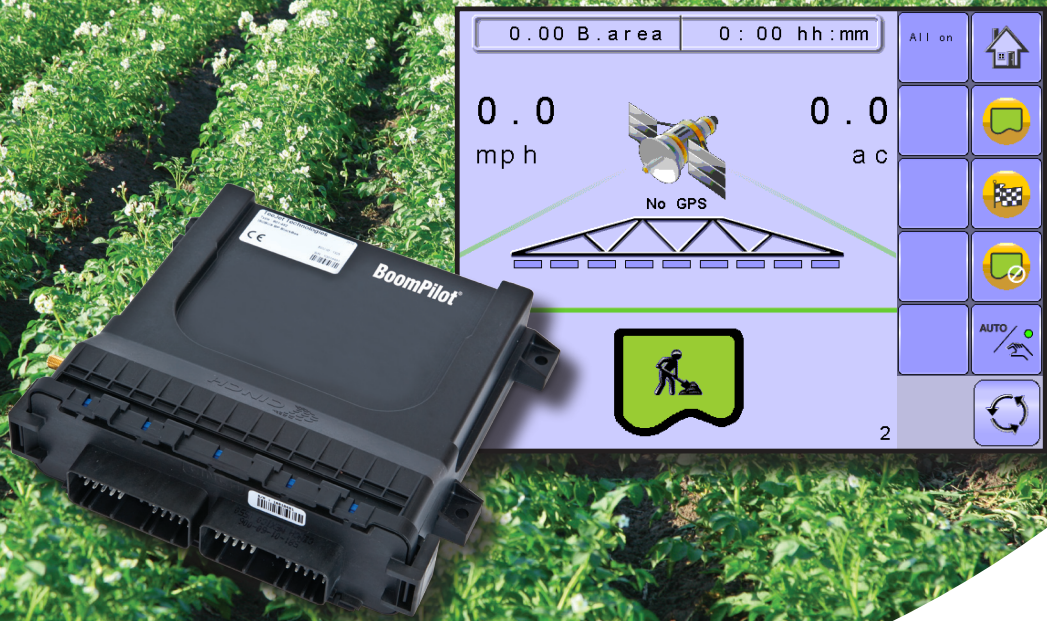

Software version 0.00



**TeeJet**®  
TECHNOLOGIES

A Subsidiary of  Spraying Systems Co.®

## COPYRIGHTS

© 2011 TeeJet Technologies. All rights reserved. No part of this document or the computer programs described in it may be reproduced, copied, photocopied, translated, or reduced in any form or by any means, electronic or machine readable, recording or otherwise, without prior written consent from TeeJet Technologies.

## TRADEMARKS

Unless otherwise noted, all other brand or product names are trademarks or registered trademarks of their respective companies or organizations.

## LIMITATION OF LIABILITY

TEEJET TECHNOLOGIES PROVIDES THIS MATERIAL "AS IS" WITHOUT WARRANTY OF ANY KIND, EITHER EXPRESSED OR IMPLIED. NO COPYRIGHT LIABILITY OR PATENT IS ASSUMED. IN NO EVENT SHALL TEEJET TECHNOLOGIES BE LIABLE FOR ANY LOSS OF BUSINESS, LOSS OF PROFIT, LOSS OF USE OR DATA, INTERRUPTION OF BUSINESS, OR FOR INDIRECT, SPECIAL, INCIDENTAL, OR CONSEQUENTIAL DAMAGES OF ANY KIND, EVEN IF TEEJET TECHNOLOGIES HAS BEEN ADVISED OF SUCH DAMAGES ARISING FROM TEEJET TECHNOLOGIES SOFTWARE.

To ensure optimal use of the equipment, please read this manual thoroughly. Please contact TeeJet Technologies Customer Support or an authorized TeeJet Technologies dealer if additional support is required.

## RESPONSIBILITY FOR USE OF THIS PRODUCT

Regarding responsibility for use of this product, we refer to our sales and delivery terms which states:

### **Product Usage**

Any use of the product is at the sole risk of the buyer. The buyer is therefore not entitled to any form for compensation caused by, for example, any of the following:

- ▶ Disturbance to/from any electronic services or products that do not conform to the standards for CE marketing;
- ▶ Missing or poor signal coverage or a succession hereof from external transmitters/receivers used by the buyer;
- ▶ Functional faults which apply to or from a PC-program or PC equipment not delivered by the seller;
- ▶ Faults that may arise from the buyers' negligence to react to warnings and fault messages from the product or that can be traced to negligence and/or absent constant control of the work carried out in comparison to the planned job.

When implementing any new equipment the buyer must take great care and pay attention. Any doubts as to the correct operation/use should result in contacting the seller's service department.

## Table of Contents

<b>CHAPTER 1 – PRODUCT OVERVIEW</b>	<b>1</b>
<b>OPTIONAL SYSTEM COMPONENTS</b>	<b>1</b>
<b>CONFIGURATIONS</b>	<b>3</b>
<b>CHAPTER 2 – GETTING STARTED</b>	<b>4</b>
<b>START UP</b>	<b>4</b>
<b>PAGE LAYOUT AND NAVIGATION</b>	<b>5</b>
Home Screen .....	5
Operation Mode .....	6
Main Setup Mode .....	7
<i>Main Setup Menu Icons and Section Overviews</i> .....	8
<b>CHAPTER 3 – MAIN SETUP</b>	<b>10</b>
Main Setup Screen .....	11
Master Screen .....	12
Home Screen .....	12
<b>SETUP</b>	<b>13</b>
GPS Setup .....	13
<i>Overlapping</i> .....	13
<i>GPS Alarm</i> .....	13
<i>GPS Input</i> .....	13
Machine Setup .....	14
<i>Delay Off</i> .....	14
<i>Delay On</i> .....	14
<i>Front or Back Mounted Implement</i> .....	14
<i>Distance from Boom to Mount Point</i> .....	14
<i>Distance from Antenna to Mount Point</i> .....	14
<b>OEM</b>	<b>15</b>
<i>Antenna Machine Mounted</i> .....	15
<i>Distance from Hitch to Antenna</i> .....	15

# ISOBUS Job Computer : BoomPilot®

---

## **USER INTERFACE 16**

<i>Use Preferred VT</i> .....	16
<i>Show Number on Soft Key</i> .....	16
<i>BoomPilot ECU Number (FI)</i> .....	16

## **COMMUNICATION 17**

## **HELP 17**

Diagnostic .....	18
BoomPilot Protocol .....	18
VT Data.....	19
TECU.....	19
About .....	19

## **CHAPTER 4 – OPERATION MODE 20**

---

### **OPERATION MODE OVERVIEW 20**

Keys Descriptions .....	20
Section and Icon Descriptions .....	21
Master Screen .....	22
Home Screen .....	22

### **APPLICATION BOUNDARY 23**

Bounded Area Coverage Status.....	23
-----------------------------------	----

### **AUTOMATIC OR MANUAL SECTION CONTROL 24**

### **ALL SECTIONS ON 24**

### **BOOM SECTIONS 25**

## **APPENDIX A - FACTORY SETTINGS & RANGES 26**

---

## **APPENDIX B - UNIT SPECIFICATIONS 27**

---

OVERVIEW

GETTING STARTED

SETUP

OPERATION

APPENDIX

## CHAPTER 1 – PRODUCT OVERVIEW

BoomPilot (automatic boom section control) is possible in combination with software built into the IC18 Sprayer/ NH3 Electronic Control Unit (ECU). The ECU should be combined with the appropriate cable to interface with your BoomPilot system, spray controller and/or spraying machine for quick and easy installation. Electronic Control Units and their related cables are designed to control as many boom sections as the spray controller to which they are connect, up to a maximum of 9 boom sections.

*Figure 1-1: BoomPilot Electronic Control Unit*



## OPTIONAL SYSTEM COMPONENTS

### Matrix 570VT

The Matrix 570VT is a simple to operate, ISOBUS-certified 5.7" color touch screen display suitable for bright daylight and nighttime operation

*Figure 1-2: Matrix 570VT*



# ISOBUS Job Computer : BoomPilot®

## IC18 Sprayer/NH3 ECU

Use with your existing VT or Matrix® 570VT

- Works seamlessly and displays on any ISOBUS VT
- Easy navigation menu and data rich display
- IC18 Sprayer ECU suitable for use with NH3 and liquid fertilizer
- Automatic boom section control upgrade option
- Variable rate control available providing your VT has GPS and task control capability
- Add additional ISOBUS ECUs as your needs change
- Provides basic rate control
- Standardized plugs, cables and software simplify installation and connectivity and result in true “plug and play” technology. IC18 ECU resides on the implement, reducing hardware in the cab

Figure 1-3: IC18 Job Computer



## Switchbox

Manual section control with remote master capability. The switchboxes are available in:

- ▶ 9 section output or 8 sections and a master output.
- ▶ 6 section output or 5 sections and a master output.

Figure 1-4: Switchboxes

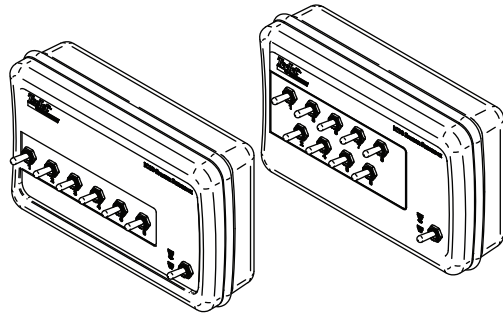

## CONFIGURATIONS

The following diagram is reflective of typical BoomPilot Job Computer configuration. Due to the variety of possible configurations, this should be used for reference purposes only.

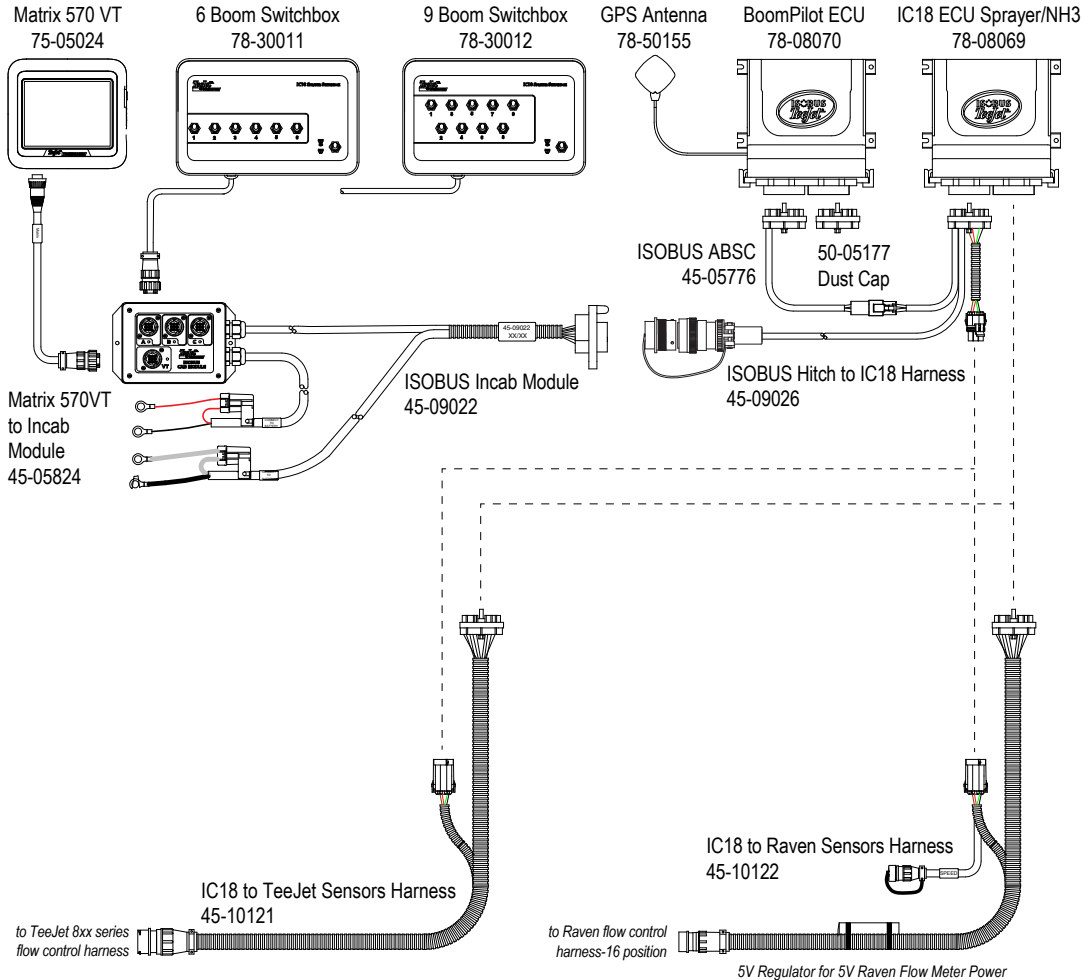

Figure 1-5: IC18 Sprayer Retro Kit to Matrix 570VT Harnessing with BoomPilot ECU and Optional Switchboxes



Included in TeeJet Retro Kit

Included in Raven 440-460 Retro Kit

## CHAPTER 2 – GETTING STARTED

- A firm touch is required when selecting a screen icon.
- Settings are NOT automatically saved when selected. The ACCEPT KEY  must be selected to save the setting. Select the ESCAPE KEY  to escape without saving settings and return to the previous menu.
- The menu structure on your display might vary from the one displayed in this User Manual depending on the virtual terminal being used.

### START UP

Power is continuously supplied to the job computer. The virtual terminal will give access to the job computer options and operation.

Figure 2-1: Master Screen

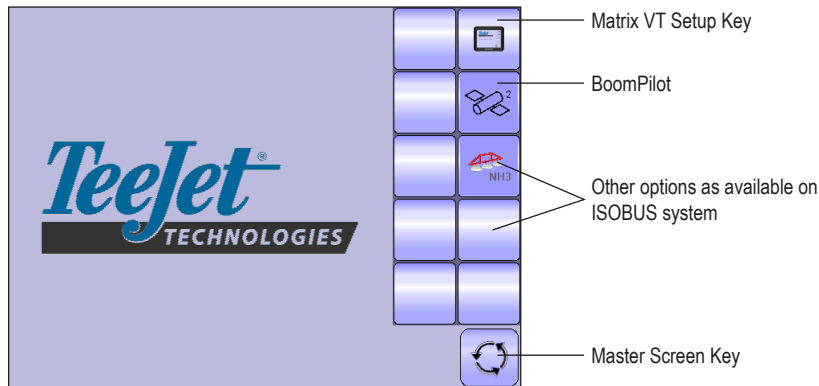



## PAGE LAYOUT AND NAVIGATION

The Master Screen gives access to the systems currently available on your VT. From the Master Screen, the Home Screen gives access to the BoomPilot ECU's available functions.

### Home Screen



The Home Screen gives access to the BoomPilot ECU's available functions: Operation Mode and Main Setup.

Figure 2-2: Home Screen - BoomPilot Mode

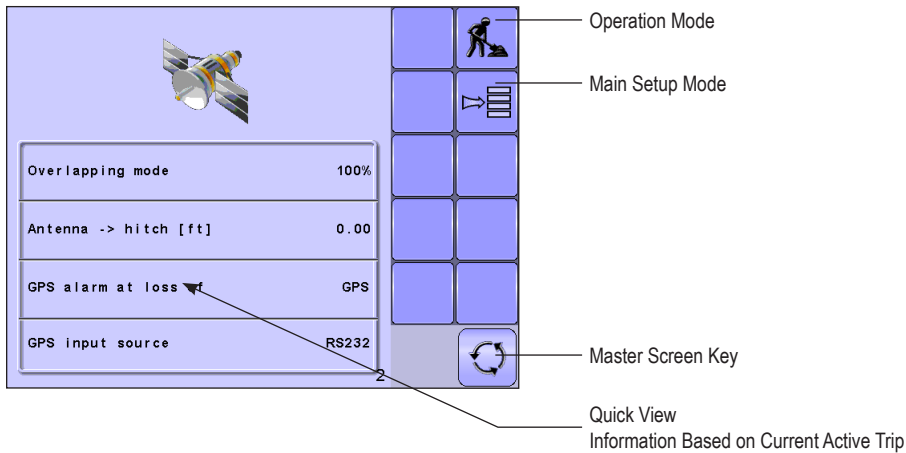

## Operation Mode



Information on the Operation screen will vary depending on the parameters set by the user and the OEM.

Figure 2-3: Operation Mode

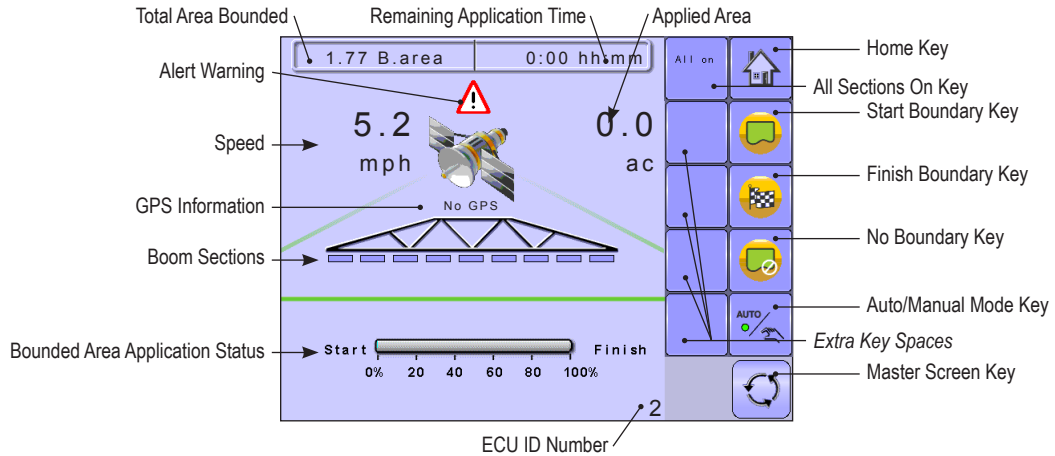

## Main Setup Mode



The main setup menu contains five options. Each of these options either directly access settings or additional menus.

Figure 2-4: Main Setup Screen

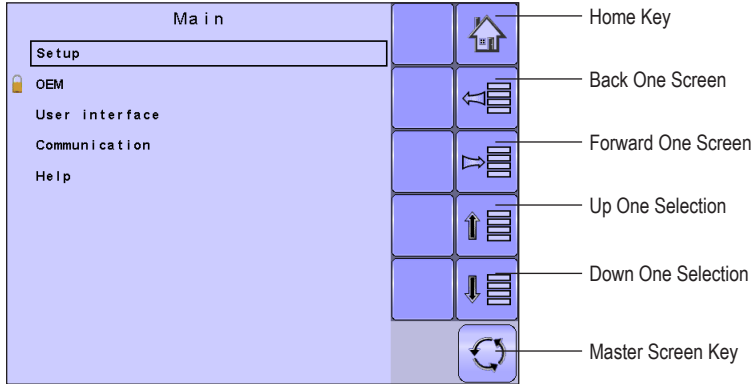

The table below outlines the additional menus.

MAIN SETUP MODE MENU STRUCTURE				
Setup	OEM	User Interface	Communication	Help
GPS Setup				Diagnostic
Machine Setup				About

*The OEM setup menu is password protected and the settings in this menu are directly related to the fitted OEM equipment.*









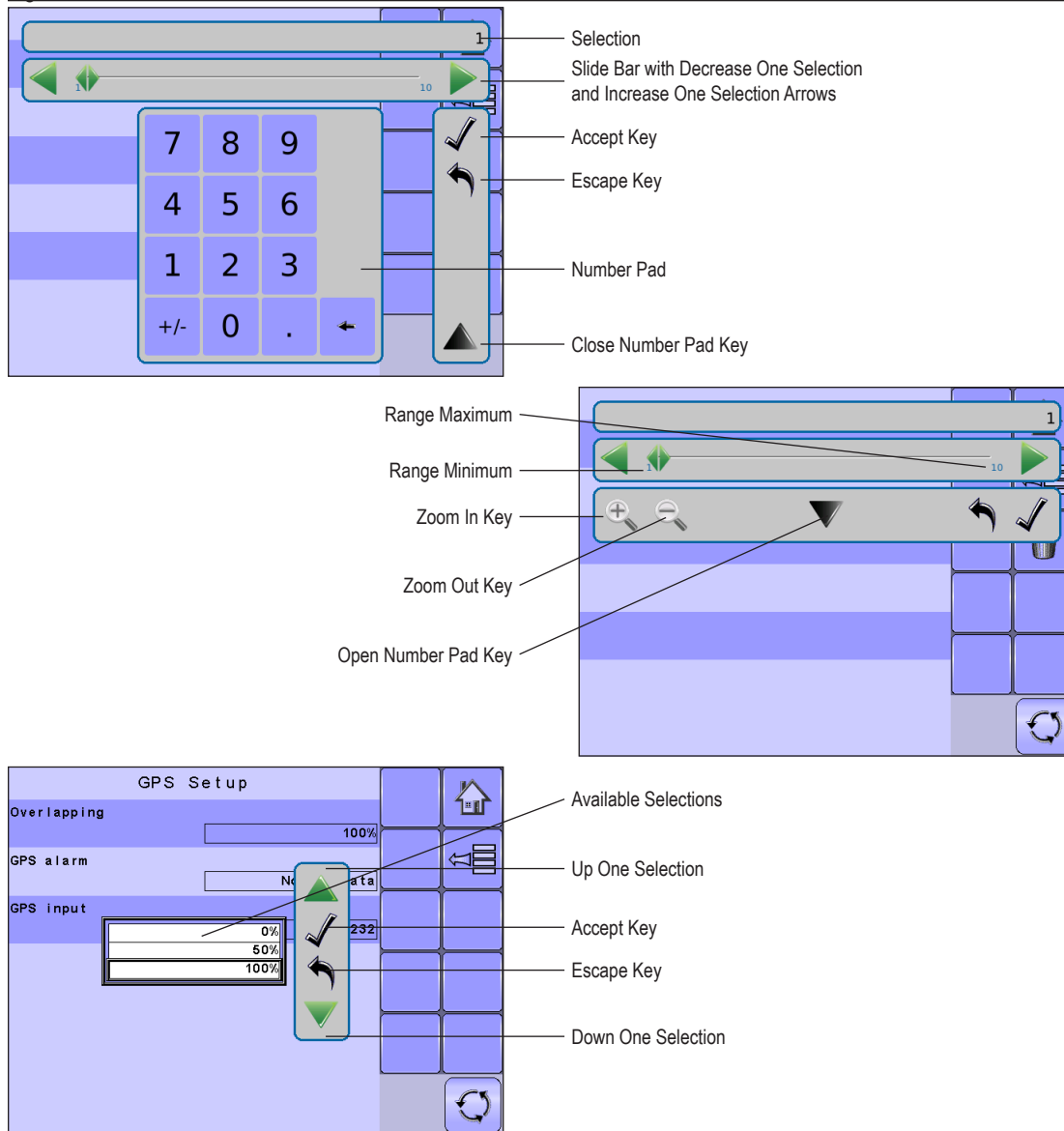

NOTE: Select functions may not be visible due to OEM settings, available equipment or sensors.

# ISOBUS Job Computer : BoomPilot®

## Main Setup Menu Icons and Section Overviews

Figure 2-5: Enter Selection Screens



Section or Icon	Description
Accept Key 	Accepts the new selection
Close Number Pad Key 	Minimizes the number pad
Decrease One Selection Arrow 	Decreases the setting
Down One Selection Arrow 	Highlights the selection below
Escape Key 	Escapes without saving changes
Increase One Selection Arrow 	Increases the setting
Number Pad	Use the numbers to set the selection value
Open Number Pad Key 	Maximizes the number pad
Selection	Displays the current or new selection
Slider 	Slide to the left to decrease or right to increase the selection
Slide Bar	Selects the setting by pressing and releasing on the slide bar or pressing and dragging the Slider to a designated value. Range for a specific setting is displayed on the slide bar.
Up One Selection Arrow 	Highlights the selection above
Zoom In Key 	Narrows slide bar range. Gray = maximum zoom level.
Zoom Out Key 	Expands slide bar range. Gray = minimum zoom level.

## CHAPTER 3 – MAIN SETUP



Main Setup Mode configures the Setup, OEM, User Interface, Communication and Help options.

*NOTE: The menu structure on your display might vary from the one displayed in this User Manual depending on the virtual terminal being used.*

Figure 3-1: Main Setup Screen

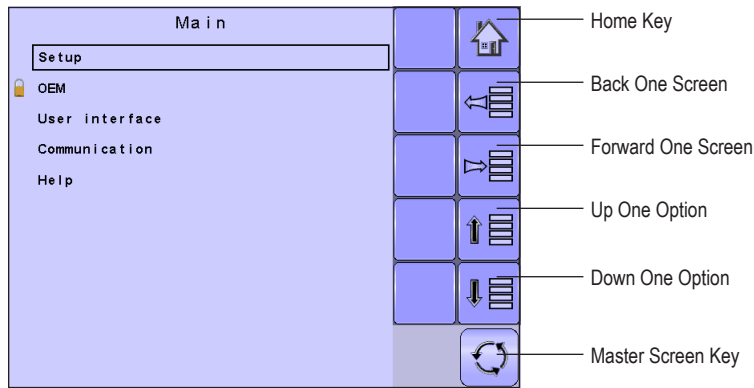



### MAIN SETUP MODE MENU STRUCTURE



Setup	OEM	User Interface	Communication	Help
GPS Setup				Diagnostic
Machine Setup				About

*The OEM setup menu is password protected and the settings in this menu are directly related to the fitted OEM equipment.*

## Main Setup Screen

*NOTE: Settings are NOT automatically saved when selected. The ACCEPT KEY  must be selected to save the setting. Select the ESCAPE KEY  to escape without saving settings and return to the previous menu.*

To access the Main Setup screens:

1. Select BOOMPILOT ECU KEY  from the Master Screen.
2. Select MAIN SETUP SCREEN KEY  from the Home Screen.
3. Select from:
  - ▶ Setup – used to configure the GPS settings and Machine settings
    - ◀ GPS Setup – used to establish the Overlapping percentage, GPS Alarm and GPS Input
    - ◀ Machine Setup – used to establish the delay off and delay on time; front or back implement mounting position; and distance from the boom and the antenna to the mounting point
  - ▶ OEM – used to establish if the antenna is machine mounted and its associated distance from the hitch
  - ▶ User Interface – used to allow the operator to select the system virtual terminal (VT) and ECU identification number
  - ▶ Communication – used to establish the BoomPilot ECU's ability to communicate with an external computer
  - ▶ Help – allows the operator to choose between Diagnostics and the About screen
    - ◀ Diagnostic – used to provide information regarding the BoomPilot protocol, VT and TECU.
    - ◀ About – used to provide information on the console such as software version, build number, etc

*NOTE: The menu structure on your display might vary from the one displayed in this User Guide depending on the virtual terminal being used. This User Guide will display all possible options.*

## Master Screen



The Master Screen gives access to the systems currently available on your VT.

- To view the Master Screen options, select MASTER SCREEN KEY  in bottom right corner of any screen.

Figure 3-2: Master Screen



Master Screen Key on Main Setup Screen

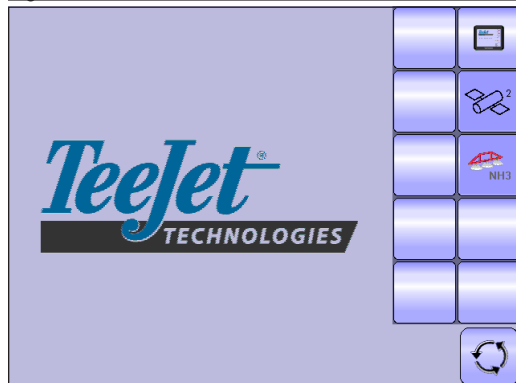
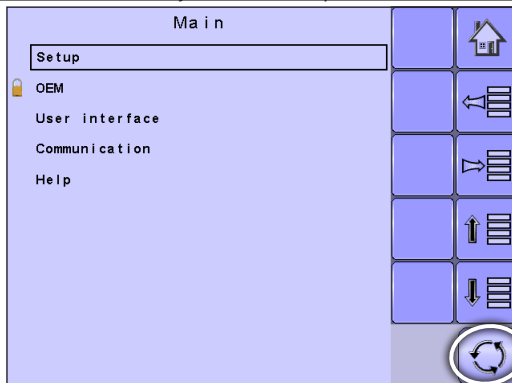

## Home Screen



The Home Screen gives access to the BoomPilot ECU's available functions: Operation Mode and Main Setup.

- To view the Home Screen, select HOME KEY  in the top right corner of any screen.

Figure 3-3: Home Screen

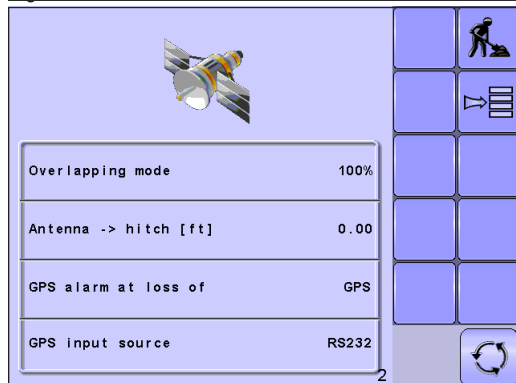

Home Key on Main Setup Screen

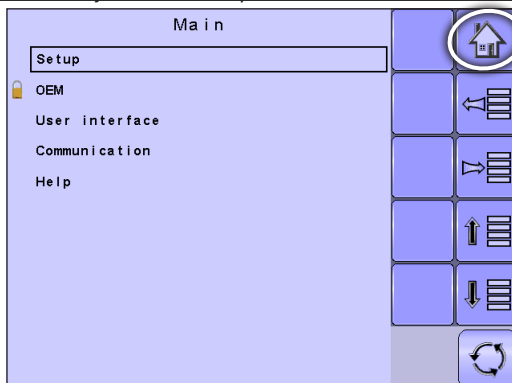



## SETUP

Setup configures the GPS settings and Machine settings.

1. From the Main Setup Screen , select SETUP.
2. Select from:
  - ▶ GPS Setup – used to establish the Overlapping percentage, GPS Alarm and GPS Input
  - ▶ Machine Setup – used to establish the delay off and delay on time; front or back implement mounting position; and distance from the boom and the antenna to the mounting point

### GPS Setup

GPS setup establishes the Overlapping percentage, GPS Alarm and GPS Input.

#### Overlapping

Overlapping determines the amount of overlap allowed when each boom section is turned on and off using Automatic Boom Section Control. Select from 0%, 50% or 100%.

- To select the Overlapping percentage, select an option from the drop down menu or use the UP/DOWN ARROWS to highlight the option.

#### GPS Alarm

GPS Alarm determine if an alarm sounds when GPS or DGPS is lost or if there are no GPS alarms.

- To select the GPS alarm type, select an option from the drop down menu or use the UP/DOWN ARROWS to highlight the option.

#### GPS Input

GPS Input determines if the GPS signal is through the internal GPS or an external RS232 port.

- To select the GPS input type, select an option from the drop down menu or use the UP/DOWN ARROWS to highlight the option.

Figure 3-4: Setup

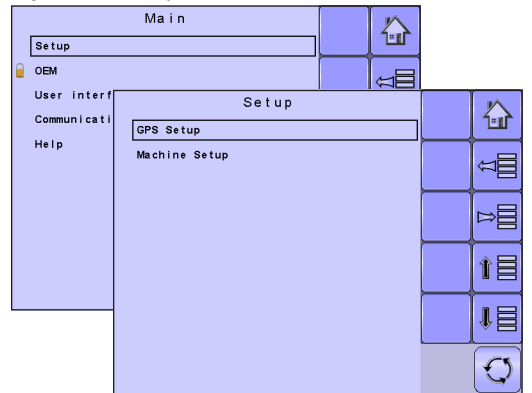

Figure 3-5: GPS Setup

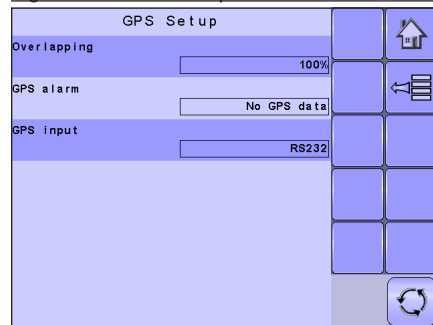
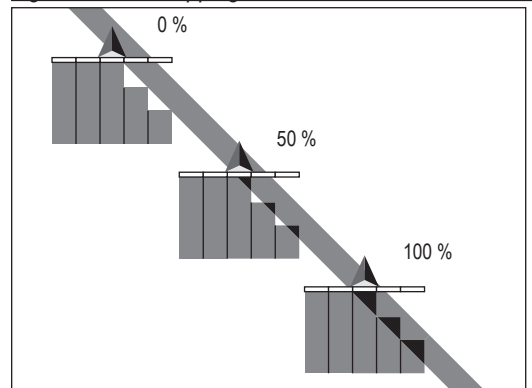

Figure 3-6: Overlapping



## Machine Setup

Machine Setup establishes the delay off and delay on time; front or back implement mounting position; and distance from the boom and the antenna to the mounting point.

### Delay Off

Delay Off functions as a “look ahead” for establishing the timing for the boom section valves to switch off exactly when entering an area that has been applied. If the boom turns off too soon when entering an applied area, decrease the Delay Off setting. If the boom turns off too late when entering an applied area, increase the Delay Off setting. Range is 0.0 - 10.0 seconds.

- To select the delay off time, use the number pad or slide bar.

### Delay On

Delay On functions as a “look ahead” for establishing the timing for the boom section valves to switch on exactly when entering an area that has not been applied. If the boom turns on too soon when entering a non-applied area, decrease the Delay On setting. If the boom turns on too late when entering a non-applied area, increase the Delay On setting. Range is 0.0 - 10.0 seconds.

- To select the delay on time, use the number pad or slide bar.

### Front or Back Mounted Implement

Direction to Boom sets whether the boom is located behind or in front of the GPS antenna as the vehicle moves in a forward direction.

- To select the mounting placement, select an option from the drop down menu or use the UP/DOWN ARROWS to highlight the option.

### Distance from Boom to Mount Point

Distance to Boom defines the distance from the hitch or mount point to the boom. Range is 0.00 - 50.00 feet / 0.00 - 50.00 meters.

- To select the distance, use the number pad or slide bar.

### Distance from Antenna to Mount Point

Distance from Antenna defines the distance from the hitch or mount point to the antenna. The antenna should be behind the mount point (machine mounting is set in OEM options). Range is 0.00 - 65.61 feet / 0.00 - 200.00 meters.

- To select the distance, use the number pad or slide bar.

Figure 3-7: Machine Setup

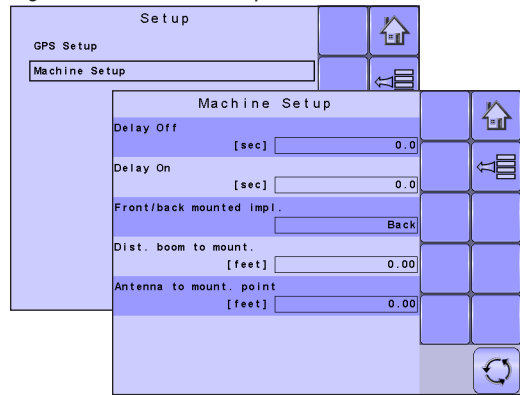
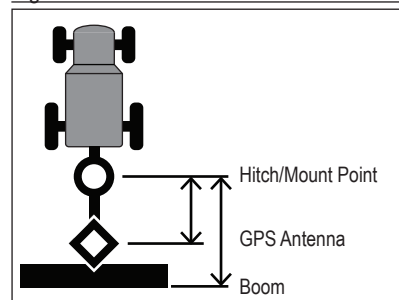



Figure 3-8: Distance to Mount Point



## OEM

The OEM setup menu is password protected and the settings in this menu are directly related to the fitted OEM equipment. To obtain an access code, contact your local dealer or TeeJet Technologies Customer Service.

To access the OEM screens:

1. From the Main Setup Screen , select OEM.
2. Select OEM.
3. Select the Access Code Entry Box to the right of the menu option.
4. Use the number pad or slide bar to enter the access code.
5. Select the ACCEPT KEY  to complete the unlock process

### Antenna Machine Mounted

Antenna Machine Mounted sets if the antenna is mounted on the machine, not the implement/boom. Range is 0.00 - 65.61 feet / 0.00 - 200.00 meters.

- To set if the antenna is machine mounted, select an option from the drop down menu or use the UP/DOWN ARROWS to highlight the option.

### Distance from Hitch to Antenna

Distance from Antenna defines the distance from the hitch or mount point to the antenna. This option is only available if the antenna is machine mounted and the "Antenna Machine Mounted" options is "Yes". Range is 0.00 - 65.61 feet / 0.00 - 200.00 meters.

- To set the distance, use the number pad or slide bar.

Figure 3-9: OEM

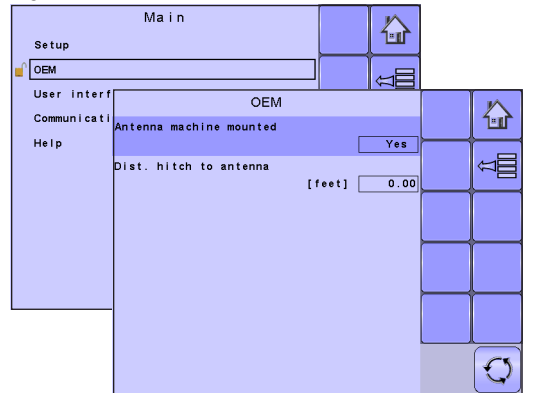

Figure 3-10: OEM Unlock

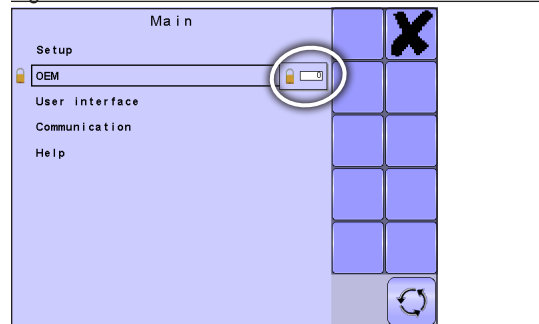
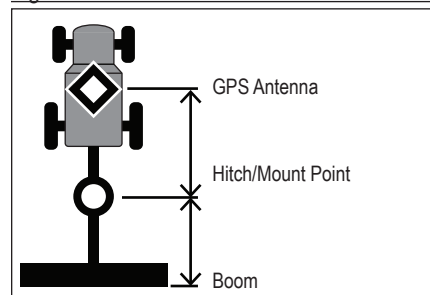

Figure 3-11: Distance from Hitch to Antenna



## USER INTERFACE

User Interface allows the operator to select the system virtual terminal (VT) and ECU identification number.

1. From the Main Setup Screen , select USER INTERFACE.

### Use Preferred VT

Use Preferred VT sets the virtual terminal preference to either on or off. If “On” is selected, the preferred VT will be used. If “Off” is selected, the system will arbitrarily select which VT to use (if more than one VT is available on the ISOBUS CAN).

- To set the Use Preferred VT mode, select an option from the drop down menu or use the UP/DOWN ARROWS to highlight the option.

*NOTE: This should always be set to "off" unless another VT is on the CAN bus.*

### Show Number on Soft Key

Show Number on Soft Key establishes if a user assigned identification number will be visible on the Master Screen, Home Screen and Operation Screen.

- To set the Soft Key Number mode, select an option from the drop down menu or use the UP/DOWN ARROWS to highlight the option.

*NOTE: Typically used only if more than one (1) BoomPilot ECU is on the CAN bus.*

### BoomPilot ECU Number (F1)

BP ECU Number is the identification number referring specifically to the BoomPilot ECU.

- To set the BoomPilot ECU Number, use the number pad or slide bar.

Figure 3-12: User Interface

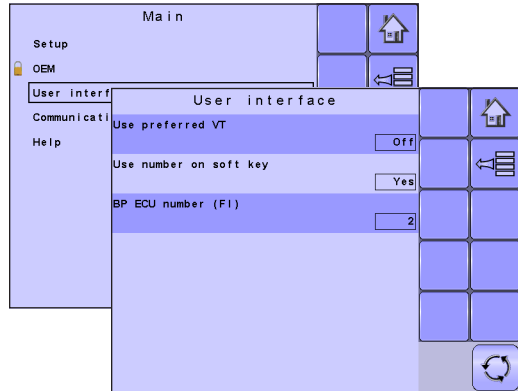
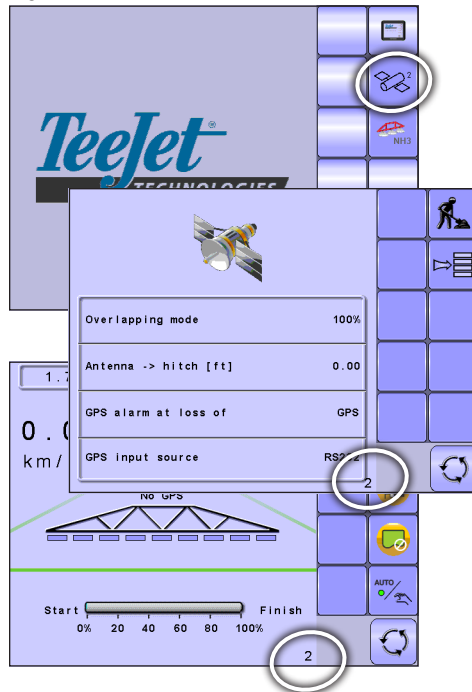

Figure 3-13: BoomPilot ECU Number



## COMMUNICATION

Communication establishes the BoomPilot ECU's ability to communicate with an external computer.

1. From the Main Setup Screen , select COMMUNICATION.

Figure 3-14: Communication

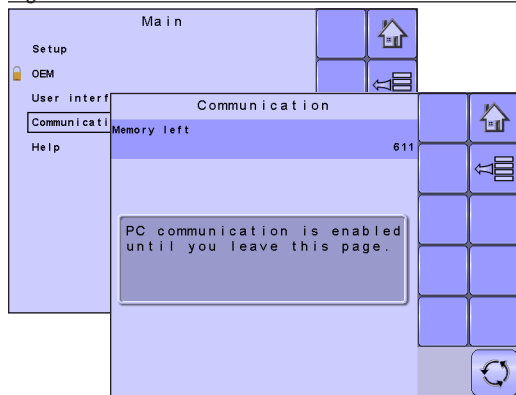

## HELP

The Help menu allows the operator to choose between Diagnostics and the display of information about serial number, CAN BUS information, etc. These menus are typically accessed upon Customer Service personnel request only.

1. From the Main Setup Screen , select HELP.
2. Select from:
  - ▶ Diagnostic – used to provide information regarding the BoomPilot protocol, VT and TECU.
  - ▶ About – provides information on the console such as software version, build number, etc.

Figure 3-15: Help



## Diagnostic

Diagnostic is used to provide information regarding the BoomPilot protocol, VT and TECU.

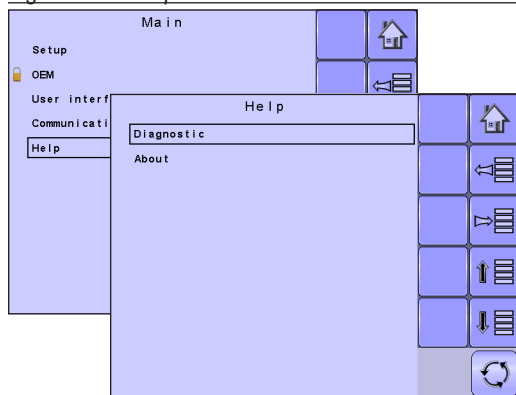
- ▶ BoomPilot Protocol – provides information regarding the IC18 pairing and the pair's associated boom sections.
- ▶ VT – provides information regarding the virtual terminal controller.
- ▶ TECU – provides information regarding the TECU.

## BoomPilot Protocol

BoomPilot Protocol provides information regarding to which IC18 ECU (per IC18 identification number) the BoomPilot ECU is paired, and the pair's associated boom sections.

Figure 3-16: Diagnostic

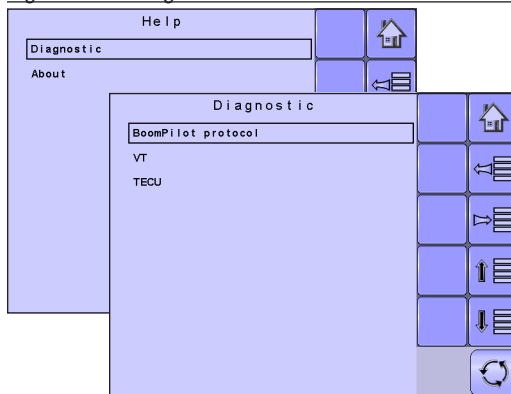
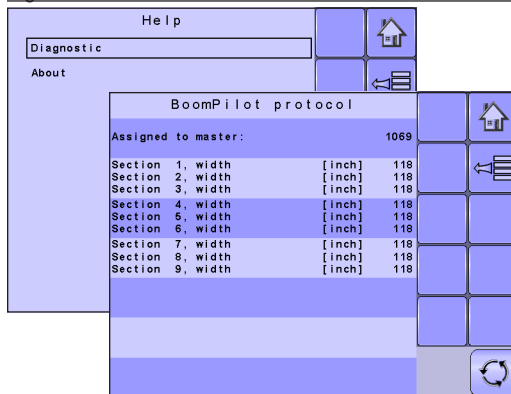



Figure 3-17: BoomPilot Protocol



## VT Data

The Virtual Terminal (VT) menu provides information regarding the virtual terminal controller (i.e., address version, etc.).

- If more terminals/controllers are used, switch between these by pressing the GO TO NEXT VT KEY  .
- Press the DELETE OBJECT POOL KEY  to upload information from the IC18 Job Computer to the Virtual Terminal.

*NOTE: Restart the IC18 Job Computer to implement and display changes.*

Figure 3-18: VT Data

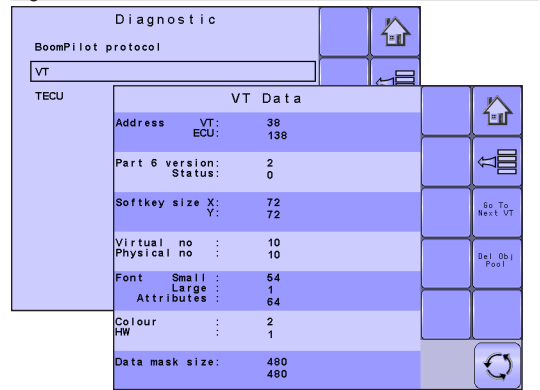

## TECU

The TECU is a control unit, residing on the tractor, that performs basic functions such as power handling, speed info, etc. The TECU data are displayed on this page.

Figure 3-19: TECU

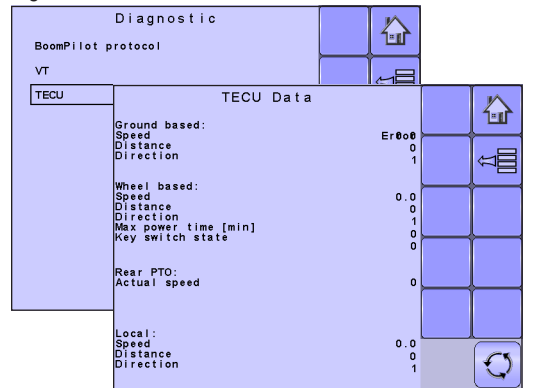

## About

The About screen provides information on the ECU such as software version, build number, etc. This information may become useful in case of technical support.

Figure 3-20: About

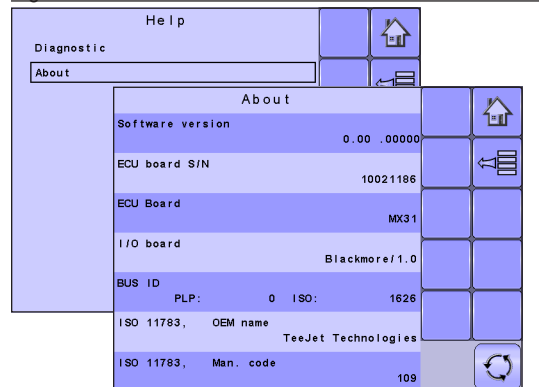

## CHAPTER 4 – OPERATION MODE



The Operation Screen accesses the working aspects of the BoomPilot ECU including boom section control and trip/application information.

**NOTE:** Settings are automatically saved when selected.

**NOTE:** The menu structure on your display might vary from the one displayed in this User Manual depending on the virtual terminal being used.

### OPERATION MODE OVERVIEW

Information on the Operation screen will vary depending on the parameters set by the user and the OEM.

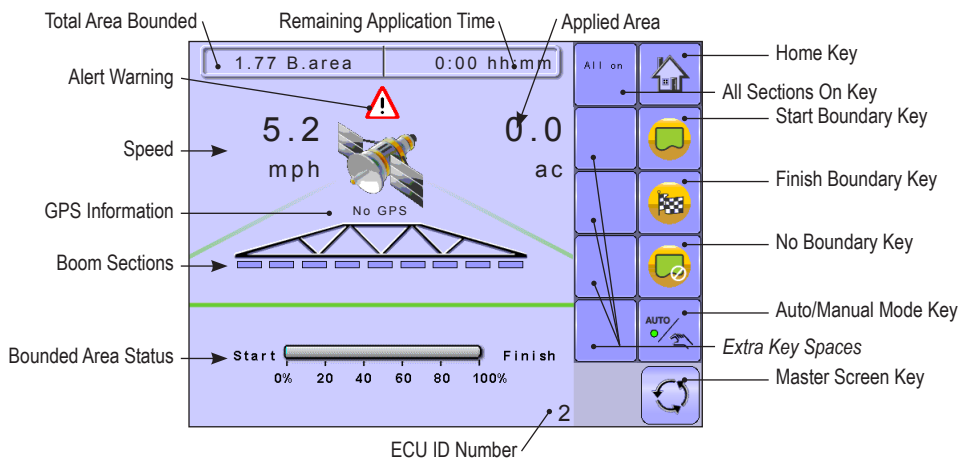

Figure 4-1: Operation Mode Screen Overview











### Keys Descriptions

Icon	Description
	Home Key Press to return to the Home Screen
	Start Boundary Key Press to start a new boundary
	Finish Boundary Key Press to finish the boundary. A straight line will complete the boundary between your current location and the starting point
	No Boundary Key Press to apply without using a boundary

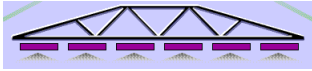
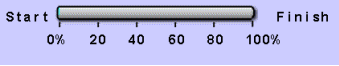

Icon	Description
	<p>Auto/Manual Key</p> <p>Press to toggle between automatic and manual application modes</p> <ul style="list-style-type: none"> <li>• Automatic mode will turn on ABSC (automatic boom section control)</li> <li>• Manual mode will turn off ABSC.</li> </ul>
	<p>All Sections On Key</p> <p>Press to turn on all sections whether or not you are in an applied or not applied area</p>

## Section and Icon Descriptions

Section or Icon	Description
Job Information	<p>This information bar displays the total area bounded and remaining application time</p> 
Total Area Bounded	Displays the total area bounded in current boundary
Remaining Application Time	Displays the amount of time remaining to completely cover the area bounded based on the current speed and rate of application
Speed	Displays vehicle speed
Applied Area	Displays the actual application per hectare/acre
Alarm 	Displayed if an alarm condition is active
GPS Information	Displays the current GPS status or mode
Boom Sections	<p>Displays the active  and inactive  boom sections as well as if they are on  (spray is blue) or off  (spray is gray).</p> 
Sprayer ID Number	Displays the soft key number assigned to the displayed IC18 ECU.
Bounded Area Status	This information section displays the current or applicaion boundary status
Bounded Area Coverage Status	<p>Displays the amount of the bounded area that has had application applied to it</p> 
Boundary In Progress	Displays when a boundary is being created 
No Boundary	Displays when no boundary is available 

## Master Screen



The Master Screen gives access to the systems currently available on your VT.

- To view the Master Screen options, select MASTER SCREEN KEY  in bottom right corner of any screen.

Figure 4-2: Master Screen



Master Screen Key on Operation Mode Screen

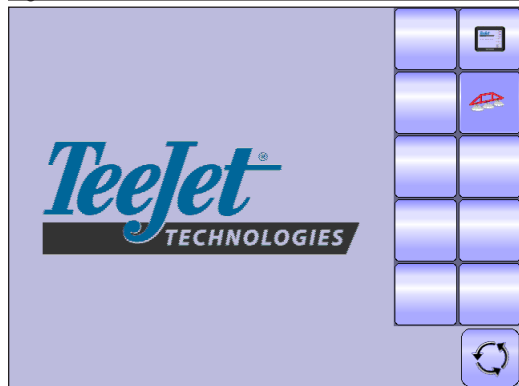
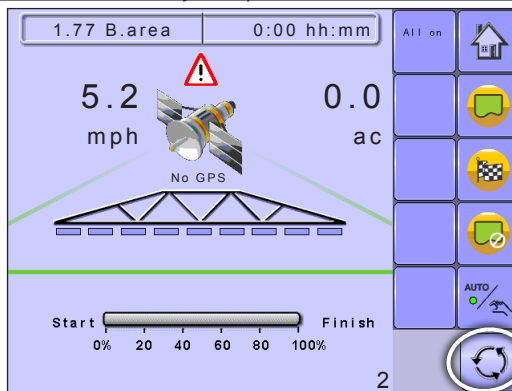

## Home Screen



The Home Screen gives access to the BoomPilot ECU's available functions: Operation Mode and Main Setup.

- To view the Home Screen, select HOME KEY  in the top right corner of any screen.

Figure 4-3: Home Screen

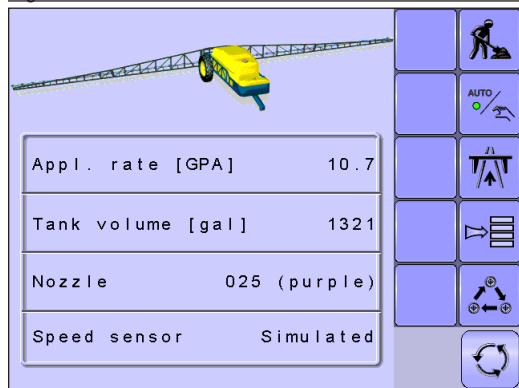

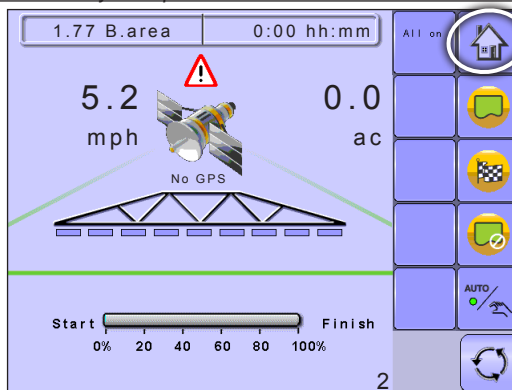

Home Key on Operation Mode Screen



## APPLICATION BOUNDARY

Application boundaries establish areas where application is and is not applied while using ABSC or BoomPilot.

To establish an application boundary:

1. Drive to a desired location at the perimeter of the field/application area.
2. Press START BOUNDARY key .
3. Travel the perimeter of the field/area.
4. Finish boundary:
  - ▶ Travel to within one swath width of the starting point. The boundary will close automatically (the operations screen will begin showing the Bounded Area Coverage Status in the Bounded Area Status section).
  - ▶ Press BOUNDARY FINISH key . A straight line will complete the boundary between your current location and the starting point

*NOTE: The boundary will not be available if the minimum distance is not travelled (five-times the swath width).*

To apply without a boundary:

1. Drive to a desired location at the perimeter of the field/application area.
2. Press NO BOUNDARY key .
3. Begin application.

## Bounded Area Coverage Status

Bounded Area Coverage Status displays the amount of the bounded area that has had application applied to it.

Figure 4-4: Boundary in Progress



Figure 4-5: Bounded Area Coverage Status

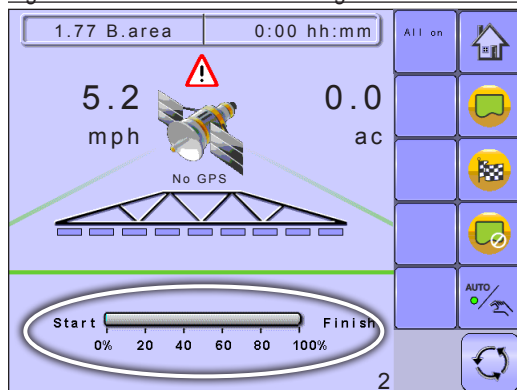

## AUTOMATIC OR MANUAL SECTION CONTROL

Automatic mode will turn on ABSC (automatic boom section control).

- Automatically control when boom sections are turned on/off as an applied area is entered/exited.

Manual mode will turn off ABSC. Section control will be controlled by the associated IC18.



- On the Operation Screen , establish Automatic Operation Mode or Manual Operation Mode by pressing the AUTO/MANUAL key  so that the green dot is on AUTO (automatic) or the hand (manual) accordingly.

Figure 4-6: Auto/Manual Key



## ALL SECTIONS ON

All Sections On will turn all sections on whether you are in an applied area or not.

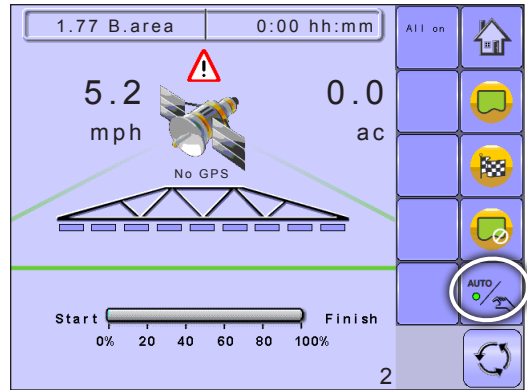
- On the Operation Screen , turn all sections on by pressing the ALL ON key .



**NOTE:** Pressing and holding the ALL ON key  will force all sections to remain on. When you release the ALL ON key , the sections will go back to the previous mode (auto/manual).

Figure 4-7: All On Key



## BOOM SECTIONS

Boom Sections displays the active  and inactive  boom sections as well as if they are on  (spray is blue) or off  (spray is gray).

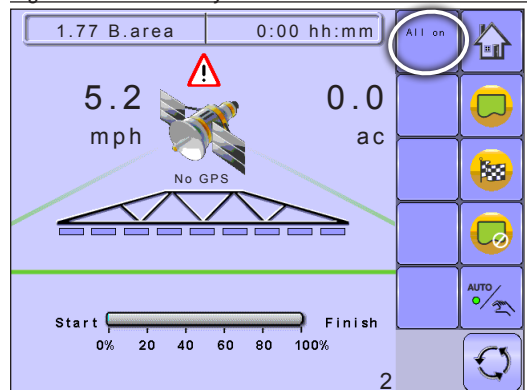
Figure 4-8: Boom Sections

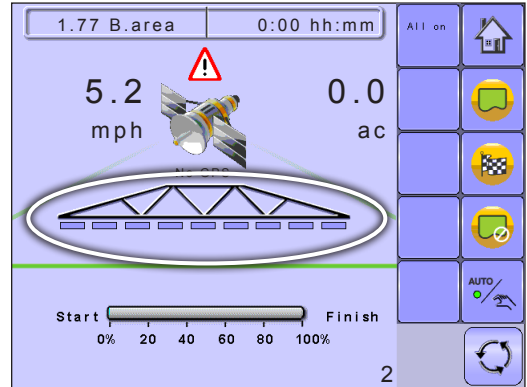

## APPENDIX A - FACTORY SETTINGS & RANGES

### SETUP

#### GPS Setup

Description	Factory Setting	Range/Options	User Setting
Overlapping	100%	0%, 50%, 100%	
GPS Alarm	No GPS Data	No GPS Data No DGPS Data No GPS Alarms	
GPS Input	Internal	Internal RS232	

#### Machine Setup

Description	Factory Setting	Range/Options	User Setting
Delay Off	0.0	0.0 - 10.0 sec	
Delay On	0.0	0.0 - 10.0 sec	
Front or Back Mounted Implement	Back	Front Back	
Distance from Boom to Mount Point	0.00	0.00 - 50.00 ft 0.00 - 50.00 m	
Distance from Antenna to Mount Point	0.00	0.00 - 65.61 ft 0.00 - 200.00 m	

#### OEM

Description	Factory Setting	Range/Options	User Setting
Antenna Machine Mounted	No	Yes No	
Distance from Hitch to Antenna	0.00	0.00 - 164.04 ft 0.00 - 500.00 m	

## USER INTERFACE

Description	Factory Setting	Range/Options	User Setting
Use Preferred VT	Off	Off On	
Show Number on Soft Key	No	No Yes	
BoomPilot ECU Number (FI)	1	1 - 9	

## APPENDIX B - UNIT SPECIFICATIONS

Dimensions	7.5 x 7.25 x 2.375 in 19.05 x 18.42 x 6.03 cm	
Weight	1.42 lbs / 0.644kg	
Connector	30 position Cinch pins. A1-K3 30 position Cinch pins. L1-Y3	
Environmental	Operating	-40 to +85°C
	Humidity	90% non-condensing
Input/Output	ISO 11783 (ISOBUS)	
Power Requirement	<9 watts @12 VDC	

# BOOMPILOT® JOB COMPUTER USER MANUAL

---

Software Version 0.00



1801 Business Park Drive  
Springfield, Illinois 62703 USA  
Tel: (217) 747-0235 • Fax: (217) 753-8426  
[www.teejet.com](http://www.teejet.com)

A Subsidiary of  *Spraying Systems Co.*

98-05210 R0 US  
© TeeJet Technologies 2011