

FIELDWARE® LINK

USER MANUAL

Software version 5.02

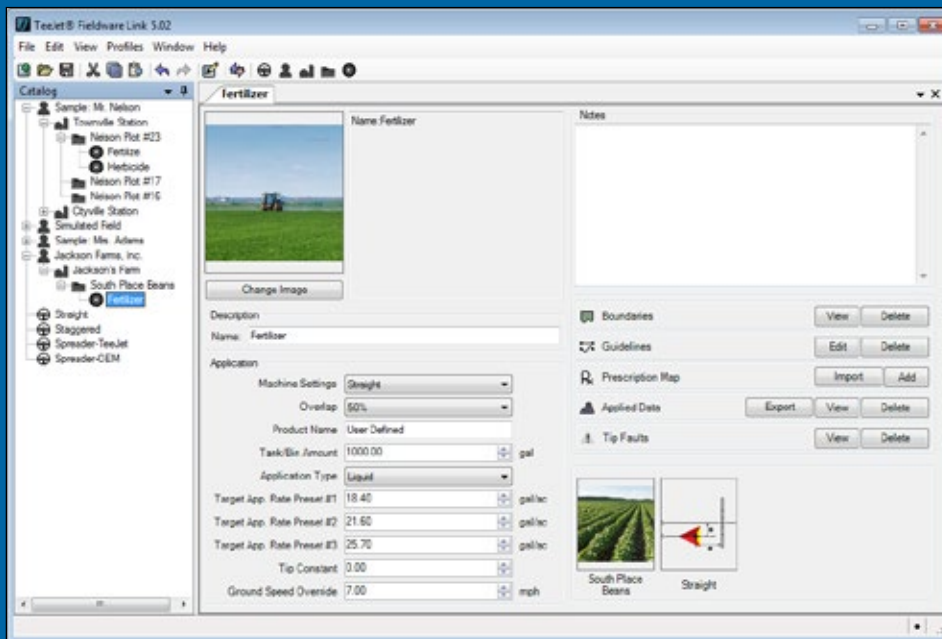

PC cataloging program user manual for the following console and software versions:

Matrix® Pro G v2.xx
Matrix® Pro GS v2.5x and v3.xx
Matrix® Pro GS v4.xx
Aeros v4.xx

MATRIX® PRO
MATRIX® PRO_{GS}
Aeros 9040

TeeJet®
TECHNOLOGIES

A Subsidiary of  Spraying Systems Co.®

FIELDWARE® LINK 5.02

Copyrights

© 2018 TeeJet Technologies. All rights reserved. No part of this document or the computer programs described in it may be reproduced, copied, photocopied, translated, or reduced in any form or by any means, electronic or machine readable, recording or otherwise, without prior written consent from TeeJet Technologies.

Trademarks

Unless otherwise noted, all other brand or product names are trademarks or registered trademarks of their respective companies or organizations.

Limitation of Liability

TEEJET TECHNOLOGIES PROVIDES THIS MATERIAL "AS IS" WITHOUT WARRANTY OF ANY KIND, EITHER EXPRESSED OR IMPLIED. NO COPYRIGHT LIABILITY OR PATENT IS ASSUMED. IN NO EVENT SHALL TEEJET TECHNOLOGIES BE LIABLE FOR ANY LOSS OF BUSINESS, LOSS OF PROFIT, LOSS OF USE OR DATA, INTERRUPTION OF BUSINESS, OR FOR INDIRECT, SPECIAL, INCIDENTAL, OR CONSEQUENTIAL DAMAGES OF ANY KIND, EVEN IF TEEJET TECHNOLOGIES HAS BEEN ADVISED OF SUCH DAMAGES ARISING FROM TEEJET TECHNOLOGIES SOFTWARE.

NOTE

Photos and illustrations may vary from the actual components provided. This may be due to different installation options, operation modes or production models.

Table of Contents





IMPORTANT SAFETY INFORMATION	IV
GENERAL WARNINGS AND PRECAUTIONS	IV
WELCOME TO FIELDWARE LINK	1
ABOUT FIELDWARE LINK	1
Additional Resources.....	1
SETTING THE PROGRAM LANGUAGE	2
Language Selection.....	2
Welcome Screen.....	2
Program Options.....	2
INTRODUCING FIELDWARE LINK	3
INTERFACE OVERVIEW	3
Menu Bar.....	4
File.....	4
Edit.....	4
View.....	5
Profiles.....	5
Window.....	6
Help.....	6
Toolbar.....	7
Catalog.....	8
Catalog Management.....	9
Creating a New Catalog.....	9
Opening an Existing Catalog.....	9
Auto Hide and Unhide the Catalog Window.....	9
Profile Management.....	10
View a Profile's Properties.....	10
Moving a Profile.....	10
Creating a New Profile.....	10
Duplicating a Profile.....	11
Deleting a Profile.....	12
Tabs.....	12
Tab Viewing Options.....	12
Setting up Preferences.....	14
Language Selection.....	14
Welcome Screen.....	14
Program Options.....	14
Units of Measurement.....	15
Startup Screen Preferences.....	15
Alert Messages.....	16
Recent Catalog List.....	16

WORKING WITH PROFILES

17

CATALOG AND PROFILES 17

UTILIZING PROFILE RECORDS 18

-  Job Profile 18
 - Duplicating a Job Profile for Reuse* 20
-  Machine Settings Profile 21
 - Creating a Machine Settings Profile 21
 - Standard Profile Sections 21
 - Defining Implement Types 22
 - Straight Implement Type 22
 - Spreader Implement Type – TeeJet Option 24
 - Spreader Implement Type – OEM 27
 - Staggered Implement Type 28
-  Client Profile 31
-  Farm Profile 32
-  Field Profile 33

IMPORTING/EXPORTING 34

- Exporting Profiles to a Console 34
 - Jobs with Associated Machine Settings* 35
- Importing Profiles from the Console 35

APPLICATION MAPPING

37

ACCESSING MAPS 37





OVERVIEW 37

- Map Screen Overview 38
- Menu Bar 39
 - Boundary Map 39
 - Guidelines Map 39
 - Prescription Map 39
 - Applied Data Map 39
 - Tip Faults Map 39

BOUNDARY MAP 40

- View 40
 -  *Measure Distances Tool* 40
- Delete 40

GUIDELINES MAP 41

- Add or Edit 41
 -  *New Straight AB Guideline* 41
 -  *New Curved AB Guideline* 42
 -  *Edit Guideline* 42
 -  *Measure Distances Tool* 42
 - Guideline Details* 43
- Delete 43

PRESCRIPTION MAPS 43

- Import 44
 - Shape Database Fields..... 45
- Add or Edit 46
 -  Cut Region 46
 -  Fill Region 47
 -  Measure Distances Tool 47
 - Color Range Selection 47
 - Map Details 47
 - Region Details..... 48
- Delete 48

APPLIED DATA MAP 49

- Export 49
- View 49
 -  Measure Distances Tool 49
 - Color Range Selection 50
 - Map Details 50
 - Region Details..... 50
- Delete 50

TIP FAULTS MAP 51

- View 51
 -  Measure Distances Tool 51
- Delete 51

MAPS ON A CONSOLE 52

APPENDIX A – CONFIGURATION SETTINGS 53

APPENDIX B – SUPPORTED FMIS DATA DETAILS 56

- ISO-11783 Part 10 ISOXML - "TASKDATA" 56
- Mid-Tech/TeeJet ARM..... 56
- ESRI Shapefile (SHP)..... 56
 - Supported DBF Unit Type Abbreviations 57
 - Supported DBF Table Descriptions 57
 - Supported Custom Unit Type Abbreviations 57

APPENDIX C – ISO-11783 TASKDATA.XML EXAMPLE 58

IMPORTANT SAFETY INFORMATION

All safety related and operating instructions should be read before the system is operated. Safe operation of machinery is the operators responsibility. Safety procedures must be posted close to the equipment and clearly visible to and legible by the operator. Safety procedures should meet all company and local regulations, as well as MSDS-requirements. For assistance, contact a local dealer.

Safety Alert Symbol Definitions:



DANGER! This symbol is reserved for the most extreme situations where serious personal injury or death is imminent.



WARNING! This symbol indicates a hazardous situation that could result in serious personal injury or death.



CAUTION! This symbol indicates a hazardous situation that could result in minor or moderate personal injury.



NOTE: This symbol addresses practices in which the operator should be aware.

GENERAL WARNINGS AND PRECAUTIONS



DANGER!

- Read and follow instructions. If instructions are unclear after reading the manual, please contact a local dealer.
- Keep children away from equipment.
- Do not operate machinery under the influence of alcohol or any illegal substance.
- Some systems include a fan heater. Never cover the heater otherwise there will be a serious danger of fire!



WARNING! ELECTRICAL / SHOCK HAZARDS

- Before working on any particular component, make sure that all power supplies have been switched off and cannot be accidentally switched on.
- Disconnect power leads before using an arc welder on equipment or anything connected to the equipment.
- Systems including frequency drives have a risk of electric shock due to residual voltage. It is not permissible to open the equipment neither to disconnect the system or any quick connection until 5 minutes after the power has been removed.
- Only operate the system from the power source indicated in the manual. If you are not sure of the power source, consult qualified service personnel.
- Do not use a high pressure cleaner to clean electrical components. This could damage electrical components and subject the operator to risk of electrical shock.
- The electrical supply to the equipment must be properly routed and connected to the equipment. All connections must meet the specified requirements.



WARNING! PRESSURIZED HYDRAULIC SYSTEMS

- Always wear personal protective equipment (PPE) when performing work on hydraulic systems.
- Adhere to the machine manufacture's approved maintenance instructions when working on the hydraulic system.
- Always turn equipment off when working on the hydraulic system. Take appropriate precautions when opening systems that have been previously pressurized.
- Be aware that hydraulic oil may be extremely hot and under high pressure.

**WARNING! CHEMICAL HANDLING**

- Always wear PPE when handling any chemical substance.
- Always follow safety labels and instructions provided by the chemical manufacturer or supplier.
- The operator should have full information on the nature and the quantity of the material to be distributed.
- **ADHERE TO FEDERAL, STATE AND LOCAL REGULATIONS REGARDING THE HANDLING, USE OR DISPOSAL OF AGRICULTURAL CHEMICALS.**

**WARNING! PRESSURIZED SPRAY SYSTEM**

- It is important to recognize proper safety precautions when using a pressurized spray system. Fluids under pressure can penetrate skin and cause serious personal injury.
- The system pressure should never exceed the lowest rated component. Always know your system and all component capabilities, maximum pressures and flow rates.
- Filters can only be opened when the manual valves in front of and behind the filter are in closed position. If any appliance has to be taken out of the piping, manual valves in front of and behind this appliance have to be in closed position. If they are reinstalled, make sure that this happens correctly, that this apparatus is well aligned, and that all connections are tight.
- The plumbing supply to the equipment should meet all company and local regulations and must be properly routed and connected to the equipment. All connections must meet the specified requirements
- It is advised to drain and purge the liquid train when the equipment shall not be used for a longer period of time.

**WARNING! AUTO STEERING SAFETY**

- To prevent serious personal injury or death from being run over by the vehicle or automated motion of the steering system, never leave the vehicles operator seat with the system engaged.
- To prevent serious personal injury or death from being run over by the vehicle or automated motion of the steering system, verify the area around the vehicle is clear of people or obstacles before startup, calibration, tuning or engaging the system.
- Make sure equipment is tightly secured to the proper components.
- Never drive on public roads with system engaged.

**CAUTION! EQUIPMENT SAFETY, MAINTENANCE, AND SERVICE**

- The equipment should be operated only by properly trained, qualified personnel. They must have proven their skills in the operation of the equipment.
- Before using the equipment, the operator has to check if the equipment is in good condition and can be used safely. If not, the equipment cannot be used.
- All necessary PPE must be readily available to the operator at all times.
- Routinely check the system and components for wear and damage. Replace or repair when necessary.
- Only qualified authorized experts are allowed to repair or maintain the installation. The maintenance and operating instructions shall be rigidly observed and followed.
- A complete manual for the equipment must be available to the operator or maintenance technician at all times.



CAUTION! HARNESS CABLE AND HOSE SAFETY

- Routinely check all harness cables and hoses for damage or wear. Replace or repair when necessary.
- Do not route harness cables and hoses with sharp bends.
- Do not strap harness cables and hoses to lines with high vibration or spikes in pressure.
- Do not strap harness cables and hoses to lines transporting hot fluids.
- Protect harness cables and hoses from sharp objects, equipment debris, and material buildup.
- Allow sufficient length for harness cables and hoses to have free movement on sections that move during operation, and be sure that harness cables or hoses do not hang below the equipment.
- Allow sufficient clearance for harness cables and hoses from implement and machine operational zones.
- When cleaning equipment, protect harness cables from high pressure wash.



NOTE: TOUCH SCREEN CARE

- Keep sharp objects away from the touch screen device. Touching the screen with a sharp object could result in damage to the display.
- Do not use harsh chemicals to clean the console/display. The correct way to clean a console/display is to use a soft damp cloth or anti-static wipe, similar to cleaning a monitor on a computer.



NOTE: RECOMMENDED REPLACEMENT PARTS

- The system has been designed with components that work together to provide the best system performance. When the system requires replacement parts, only TeeJet recommended components should be used to maintain proper system operation and safety.

WELCOME TO FIELDWARE LINK

ABOUT FIELDWARE LINK

Fieldware Link is a data management application designed to compliment consoles manufactured by TeeJet Technologies. The application can be used to enhance year to year data retention and assist in future preparation. This software is for TeeJet customers using Matrix Pro G, Matrix Pro GS or Aeros consoles managing Job data.

Application Purpose:

- ▶ Store Job data acquired from TeeJet consoles
- ▶ Creation and management of Machine Settings
- ▶ Transfer Job profiles with supported Machine Settings to a console
- ▶ Reuse guidelines, boundaries, applied data, and ISOXML prescription files
- ▶ Convert supported prescription map files into usable TeeJet format

RECOMMENDATION: Although Fieldware Link will support map conversion, it is recommended to use Fieldware Convert.

Additional Resources

Contact information for technical support, software updates, and release notes can be located at www.teejet.com.

Figure 1: Welcome Screen

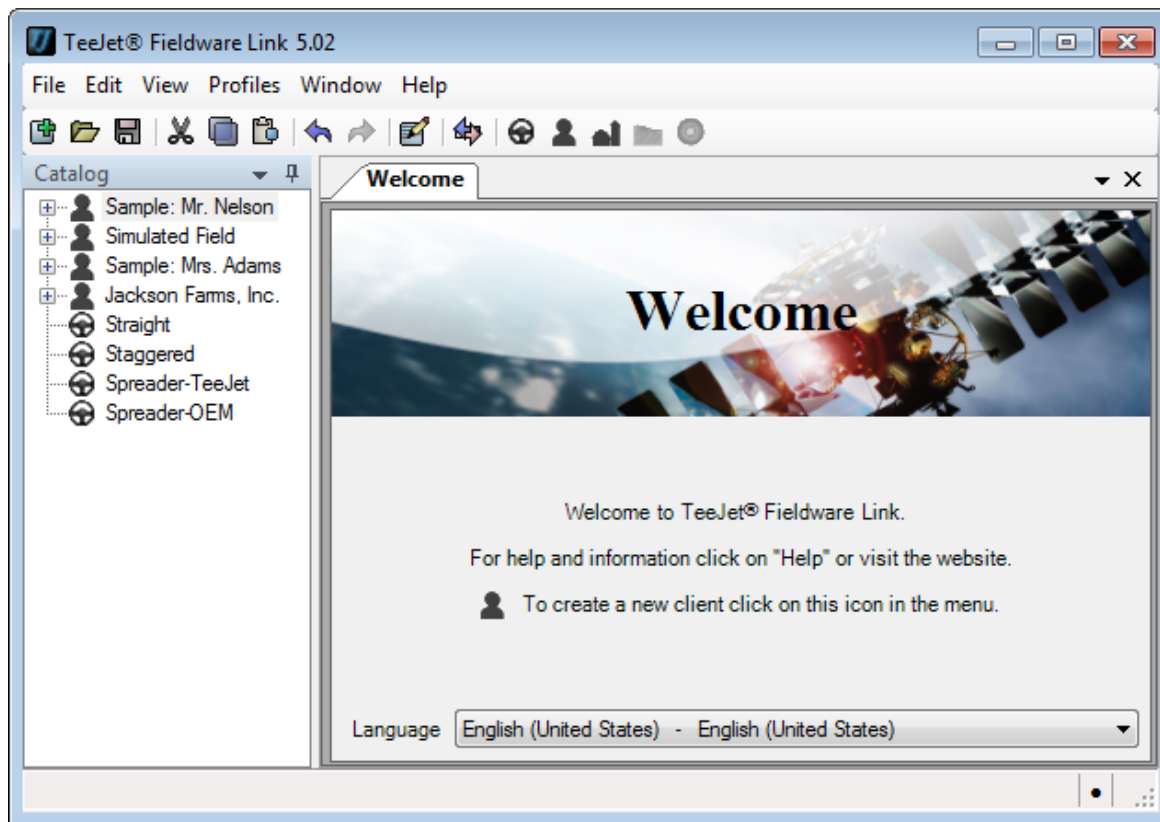

SETTING THE PROGRAM LANGUAGE

Language Selection

The program language can be changed from the Welcome Screen or in the program options.

Welcome Screen

1. Click the down arrow ▼ to show list of available languages
2. Select preferred language

Figure 2: Language Selection – Via Welcome Screen

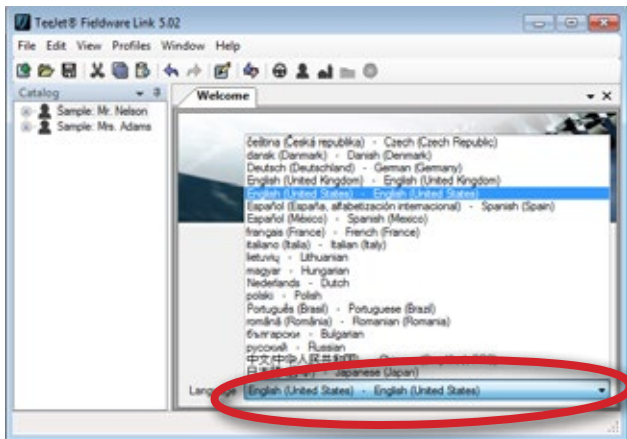

Program Options

1. Select View from the main toolbar menu
2. Click **Options** to open the Options page
3. Click Down arrow ▼ to show list of available languages
4. Select preferred language

Figure 3: Language Selection – Via Options Menu

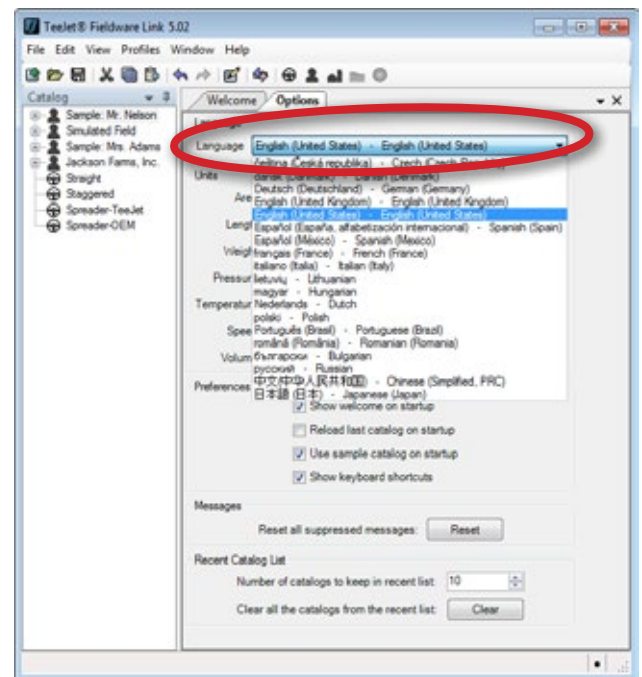

INTRODUCING FIELDWARE LINK

INTERFACE OVERVIEW

Fieldware Link software is designed as a record keeping supplement to the Matrix Pro and Aeros consoles. This chapter will provide an overview of the interface and demonstrate how to customize the workspace. Listed below are main components of the Fieldware Link interface.

- Menu Bar – provides navigation to all functions
- Toolbar – includes buttons for quick access to common commands and tools
- Catalog – a collection profiles used to store data
- Tabs – display open profiles
- Status Bar – indicates when a Catalog has been changed and not saved by displaying a black dot at the bottom of the window

Figure 4: Interface Overview

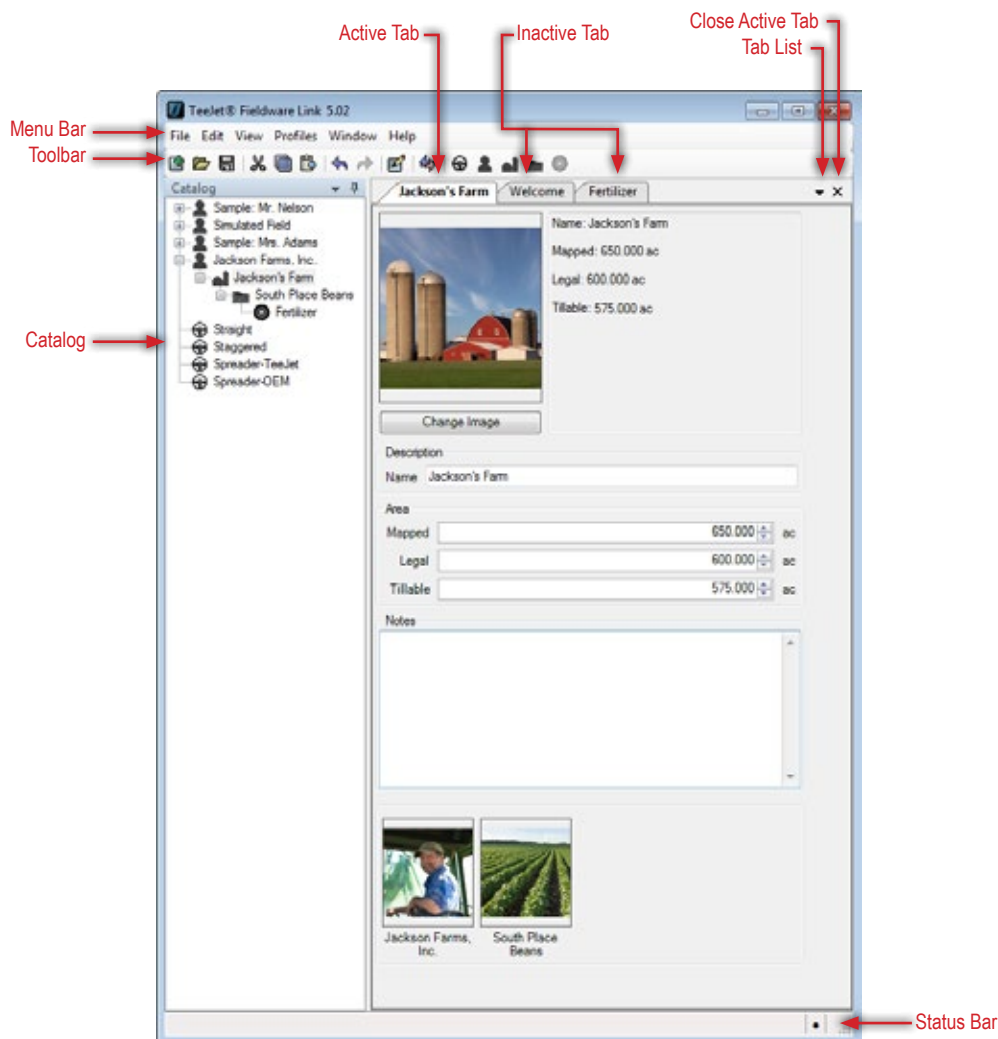

Menu Bar

The menu bar provides navigation to all file functions.

Most of the menu functions can be accomplished with a click of the toolbar or right-click on the catalog.

File

The File menu contains commands that relate to managing catalogs.





NOTE: Jobs are created and loaded using the New Client , Farm , Field  or Job  buttons, menu options, or catalog right-click options.

Figure 5: File Menu

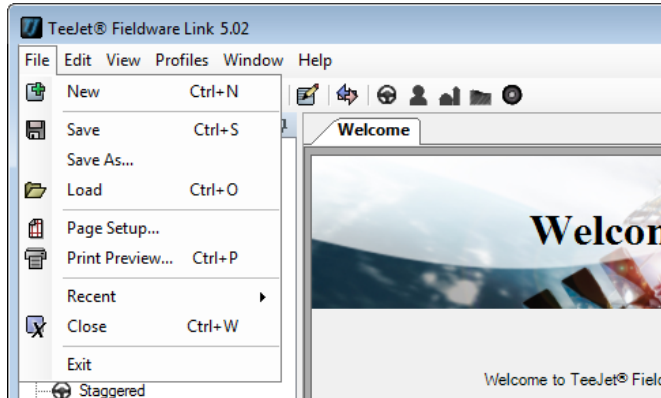







Table 1: File Menu Options

Icon	Description
	New – creates a new Catalog
	Save/Save As – saves the current open Catalog
	Load – opens an existing Catalog
	Page Setup – select paper size, printing source, page orientation and margin setup
	Print Preview – displays a preview the page to be printed and provides the option to print
no icon	Recent – provides a list of recent Catalogs. Number of recent Catalogs to be shown can be set under View -> Options
	Close – closes the Catalog
no icon	Exit – closes the Fieldware Link software

Edit

The Edit menu contains commands that relate to changing a catalog or profiles.

- ▶ To cut, copy, paste or delete a Catalog item, highlight the appropriate profile on the Catalog, then choose the appropriate command.

Figure 6: Edit Menu

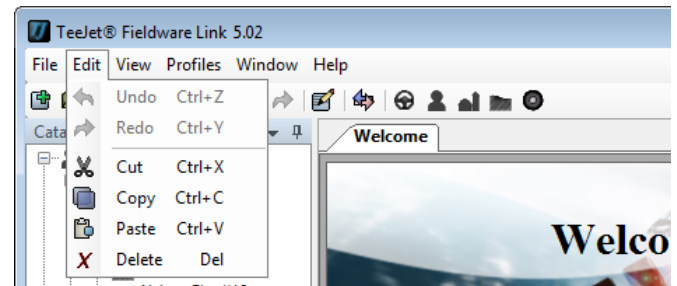







Table 2: Edit Menu Options

Icon	Description
	Undo/Redo – ability to step forward or step backward regarding recent file commands
	Cut – remove selected data while creating a duplicate
	Copy – create a duplicate of selected data while leaving original data in place
	Paste – insert copied data from the clipboard
	Delete – discard selected data

View

The View menu provides access to profile properties, import/export functions, search command, calculator, the units converter tool, and preferences.

Figure 7: View Menu

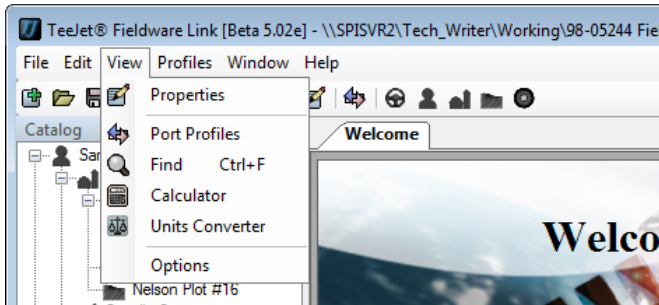

Table 3: View Menu Options

Icon	Description
	Properties – access details and setup information for the currently selected profile
	Port Profiles – export/import information from or to the Matrix Pro, Matrix Pro GS or Aeros consoles
	Find – search for information based on a word or phrase
	Calculator – a tool used for multiple types of calculations
	Units Converter – convert area, length, weight, pressure, temperature, speed or volume from one unit of measurement to another
no icon	Options – set preferences such as language, units of measurement, recent catalog list management, and startup screen options

Profiles

The Profiles menu contains commands used to add profiles to a new or existing Catalog.

- ▶ New Farms, Fields or Job profiles will be placed under the selected Client.

NOTE: Farm Field and Job profiles can only exist under a Client. However, these profiles can be reorganized under a currently selected Client or moved to another Client under the open Catalog by using the drag and drop method.

- ▶ Machine Settings can not be placed under any profile, they can only be associated to a Job profile under the application section.

Figure 8: Profiles Menu

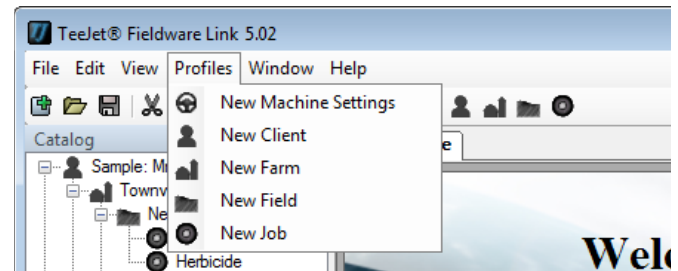

Table 4: Profiles Menu Options

Icon	Description
	New Machine Settings – creates a new profile used to organize equipment settings
	New Client – creates a new profile providing information regarding a person or organization
	New Farm – creates a new profile under the selected Client that organizes a client's farm or organization information <i>NOTE: If no Client is selected, the New Farm button will be grayed out.</i>
	New Field – creates a new profile under the selected farm that organizes data from separate fields or areas <i>NOTE: If no Farm is selected, the New Field button will be grayed out.</i>
	New Job – creates a new profile under the selected field that retains information about a particular assignment <i>NOTE: If no Field is selected, the New Job button will be grayed out.</i>

Window

The Window menu can be used to organize open tabs.

Figure 9: Window Menu

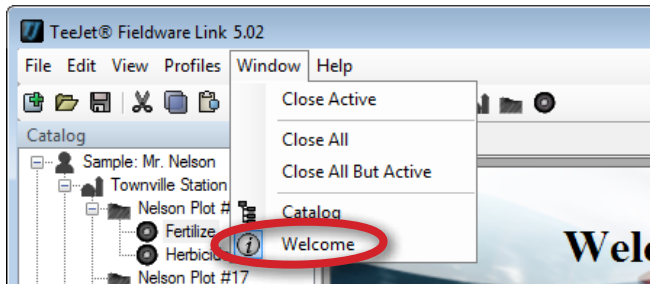



Table 5: Window Menu Options

Icon	Description
no icon	Close Active – close only the active tab
no icon	Close All – close all tabs
no icon	Close All But Active – close all tabs except for the active tab
	Catalog – displays organization of Machine Settings, Clients, Farms, Fields and Job profiles
Icon varies based on the open window	A list of all open tabs will be listed here for viewing and access <i>Example: The Welcome screen is open in the above screen shot.</i>

Help

The Help menu allows the user to obtain assistance, access www.teejet.com or Fieldware Link software information.

Figure 10: Help Menu

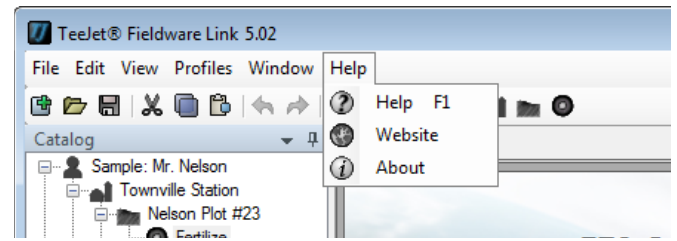





Table 6: Help Options

Icon	Description
	Help – opens the user manual for assistance
	Website – provides a link to www.teejet.com
	About – provides software version and copyright information

Toolbar

The toolbar provides quick one-click access to common menu functions. Hover over any button to view the button definition.

Figure 11: Toolbar one-click access

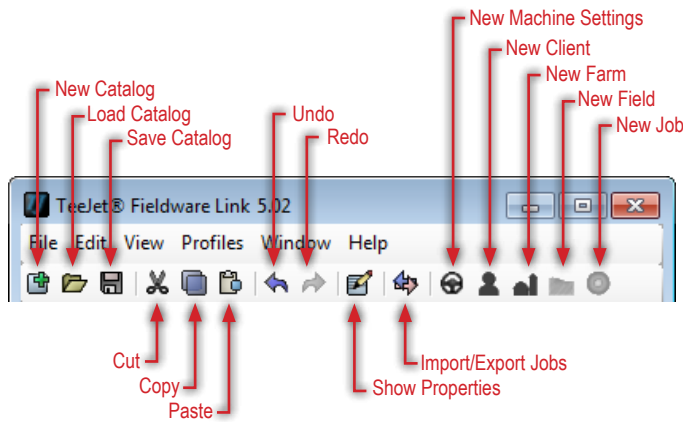
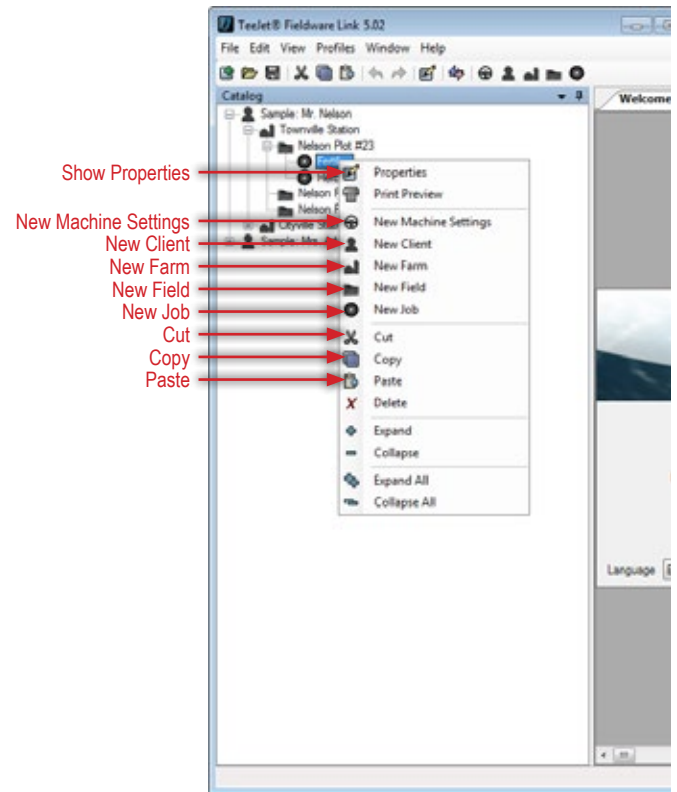

Table 7: Toolbar Options

Icon	Description
	New Catalog – creates a new Catalog
	Load Catalog – opens an existing Catalog
	Save Catalog – saves the current open Catalog
	Show Properties – access Machine Settings, Client, Farm, Field or Job profiles
	Port Profiles – export/import information between Fieldware Link and the Matrix Pro, Matrix Pro GS or Aeros consoles
	New Machine Settings – creates a new profile used to organize equipment settings
	New Client – creates a new profile providing information regarding a person or organization
	New Farm – creates a new profile under the selected Client that organizes a client’s farm or organization information <i>NOTE: If no Client is selected, the New Farm button will be grayed out.</i>
	New Field – creates a new profile under the selected Farm that organizes data from separate fields or areas <i>NOTE: If no Farm is selected, the New Field button will be grayed out.</i>
	New Job – creates a new profile under the selected Field that retains information about a particular assignment. <i>NOTE: If no Field is selected, the New Job button will be grayed out.</i>

Toolbar button functionality can also be accessed from the main menu. Some functions can also be found in the Catalog right-click options as seen below.

Figure 12: Catalog right-click options for toolbar functions



Catalog

The Catalog is a set of profiles organized in traditional farming hierarchy: Machine Settings, Client, Farm, Field, and Job. The user may maintain multiple Catalogs, however only one Catalog can be open at a time. Most catalog functionality can be accessed through drop-down menus, the toolbar, or right-clicking on the Catalog window.

Figure 13: Catalog

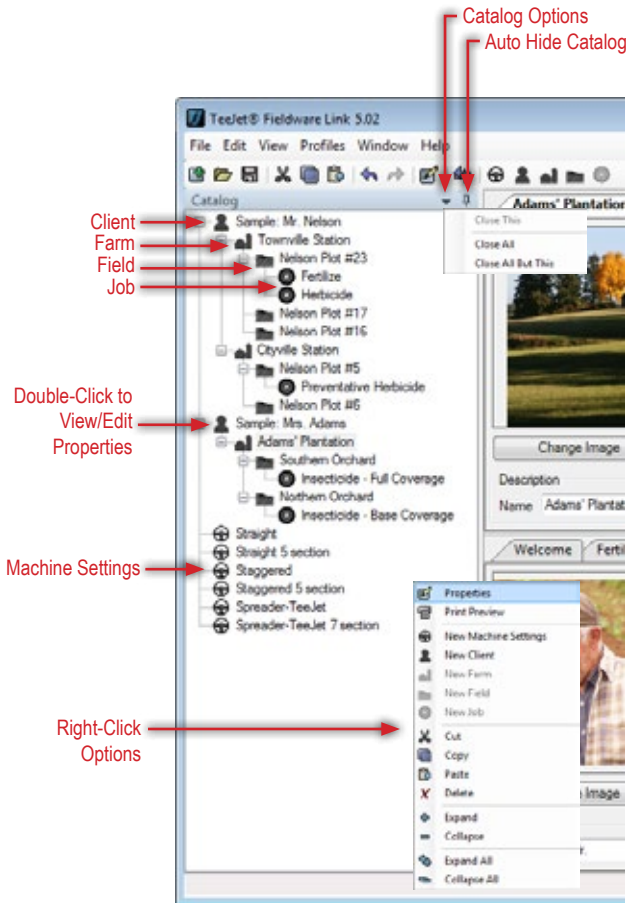

Table 8: Auto Hide Catalog & Open Tab Options

Icon	Description
	Auto Hide/Unhide – click to automatically hide or permanently show the Catalog when not in use
	Options – provides options for closing tabs

Table 9: Catalog Tools – Right Click Tool Access

Icon	Description
	Properties – access catalog Machine Settings, Clients, Farms, Fields or Jobs profile details
	Print Preview/Print – provides a preview of how the printed page will appear before clicking the print button which is also found within this option
	New Machine Settings – creates a new profile used to organize equipment settings.
	New Client – creates a new profile providing information regarding a person or organization
	New Farm – creates a new profile under the selected Client that organizes a client's farm or organization information <i>NOTE: If no Client is selected, the New Farm button will be grayed out.</i>
	New Field – creates a new profile under the selected Farm that organizes data from separate fields or areas <i>NOTE: If no Farm is selected, the New Field button will be grayed out.</i>
	New Job – creates a new profile under the selected Field that retains information about a particular assignment <i>NOTE: If no Field is selected, the New Job button will be grayed out.</i>
	Expand – expands the selected Catalog item
	Collapse – collapses the selected Catalog item
	Expand All – expands all current Catalog items
	Collapse All – collapses all current Catalog items

Catalog Management

Organize and manage profiles in a Catalog.

Creating a New Catalog

1. Click the New Catalog  button or (Ctrl N).
2. Begin building the catalog by creating new profiles.

Opening an Existing Catalog

1. Click the Load Catalog  button or (Ctrl O).
2. Browse and choose an existing Catalog.
3. Click the **Open** button.

NOTE: Only one Catalog can be open at a time. If a Catalog is already open while clicking the New or Load Catalog  button, the program will prompt to save changes to the current Catalog before closing and loading a new one.

Auto Hide and Unhide the Catalog Window



- Click the Auto Hide Catalog  button to minimize the Catalog window
- Click the Auto Unhide Catalog  button to maximize the Catalog window
- Hover over or click the Catalog Tab in the sidebar to temporarily show the Catalog Window.

Figure 14: Catalog Auto Hide Button

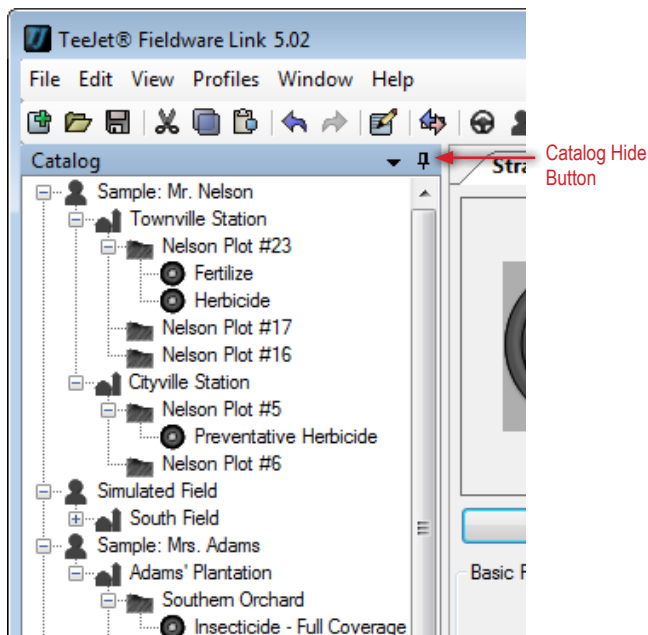

Figure 15: Catalog Auto Unhide Button

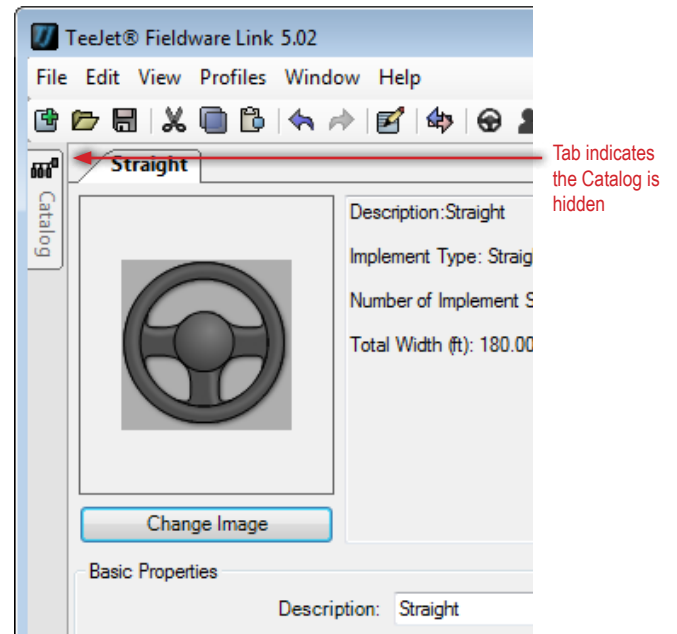
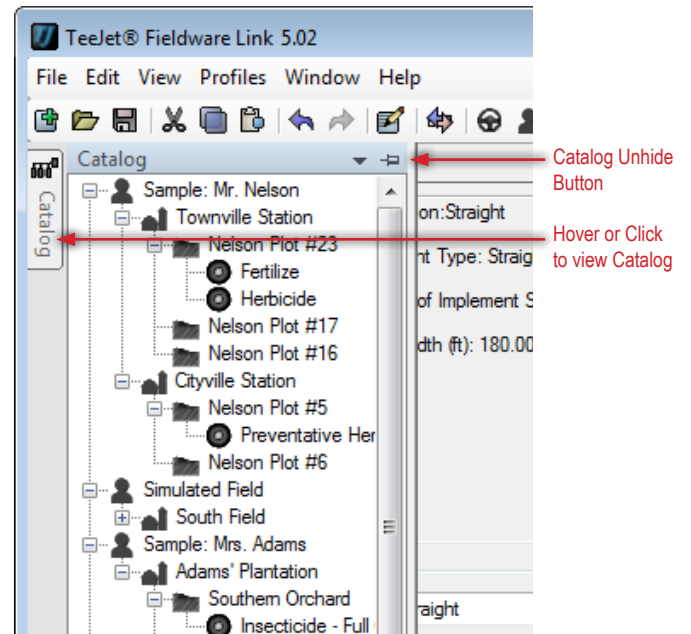

Figure 16: Hidden Catalog



Profile Management

View a Profile's Properties

To view a profile for Machine Settings, Client, Farm, Field or Job:

1. On the catalog, double-click the Machine Settings, Client, Farm, Field or Job.

OR

1. On the catalog, highlight the Machine Settings, Client, Farm, Field or Job.
2. Click PROPERTIES  toolbar option, menu option or catalog right-click option.

From the properties tab you can edit the Machine Settings, Client, Farm, Field or Job information. If an element of a catalog has been edited and not saved, a black dot will appear in the lower right-hand corner of the window.

Figure 17: Viewing Properties

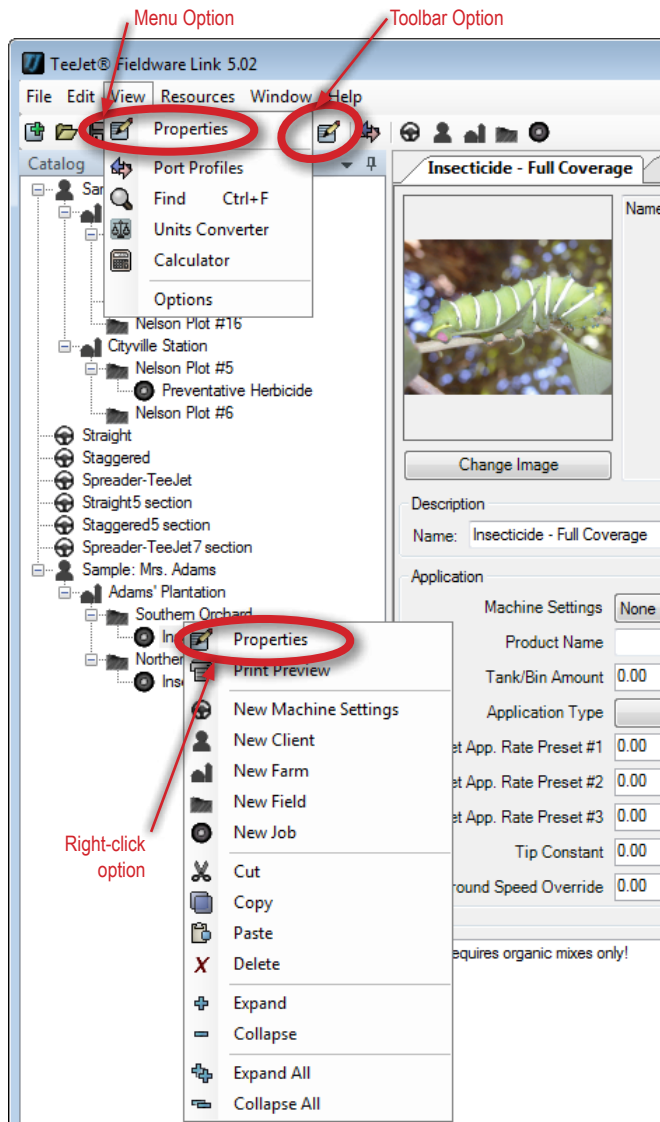

Moving a Profile

- Click and drag the profile to the appropriate location.

NOTE: The Client, Farm, Field or Job will be added to the level highlighted on the Catalog, NOT the currently viewed tab.

Creating a New Profile

Machine Settings

1. Click New Machine Settings  toolbar option, menu option or catalog right-click option

Clients

1. Click New Client  toolbar option, menu option or catalog right-click option.

Farms

1. On the catalog, highlight the client to which the farm is to be added.
2. Click New Farm  toolbar option, menu option or catalog right-click option.

Fields

1. On the catalog, highlight the farm to which the field is to be added.
2. Click New Field  toolbar option, menu option or catalog right-click option.

Jobs







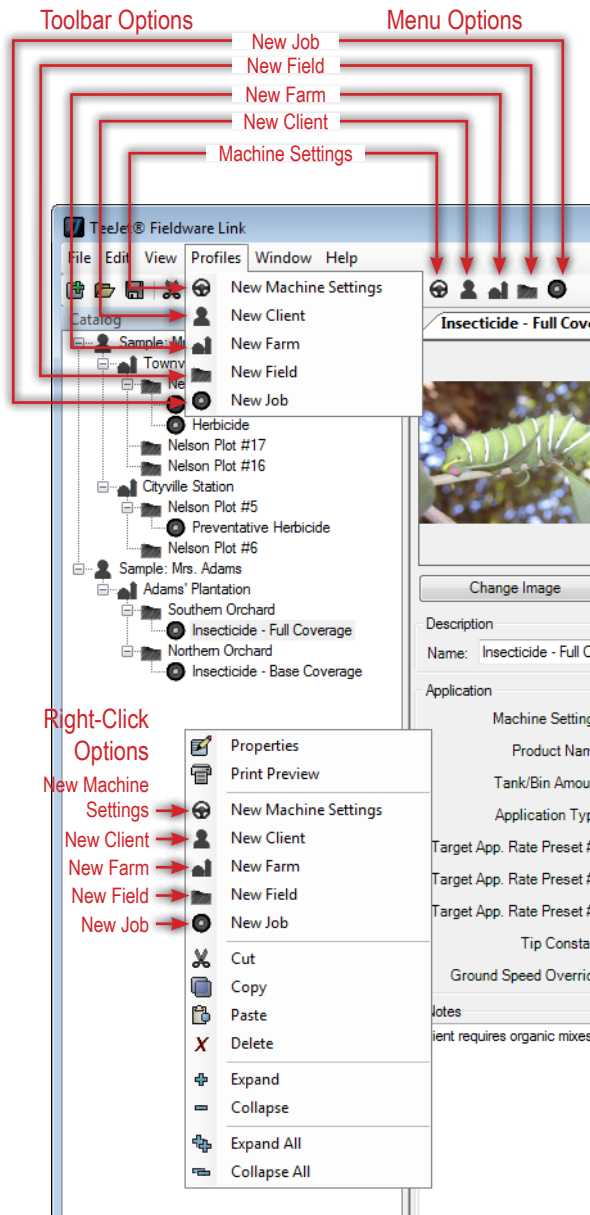

1. On the catalog, highlight the field to which the job is to be added.
2. Click New Job  toolbar option, menu option or catalog right-click option.

NOTE: Preset Catalog hierarchy will prevent the user from creating a profile out of order. For example: a new Field cannot be created without a Farm profile already existing. The hierarchy under Client is: Client, Farm, Field then Job. Machine Settings is a stand alone profile and at the same level as Client.

Figure 18: New Profile Setup



Duplicating a Profile

- On the catalog, highlight the profile which is to be duplicated.
- Copy and paste the profile.
 - ▶ Option 1: Use the right click options to cut , copy , and paste  profiles.
 - ▶ Option 2: Use the toolbar functions to cut , copy , and paste  profiles.
 - ▶ Option 3: Use the Edit Menu options to cut , copy , and paste  profiles.
 - ▶ Option 4: Use keyboard shortcuts to copy (Ctrl C), cut (Ctrl X), and paste (Ctrl V) profiles.
 - ▶ Option 5: Hold the "Ctrl" button on the keyboard while clicking and dragging to duplicate the profile and place the copied file the new selected position.
- Place cursor where the copied profile is to be placed.

NOTE: Changing the description of a Job profile does not change how a particular Job profile is recognized by your Matrix Pro, Matrix Pro GS or Aeros console. If you are attempting to create a new Job profile, please create a copy or use the appropriate new Job profile option.

Figure 19: Duplicating Properties

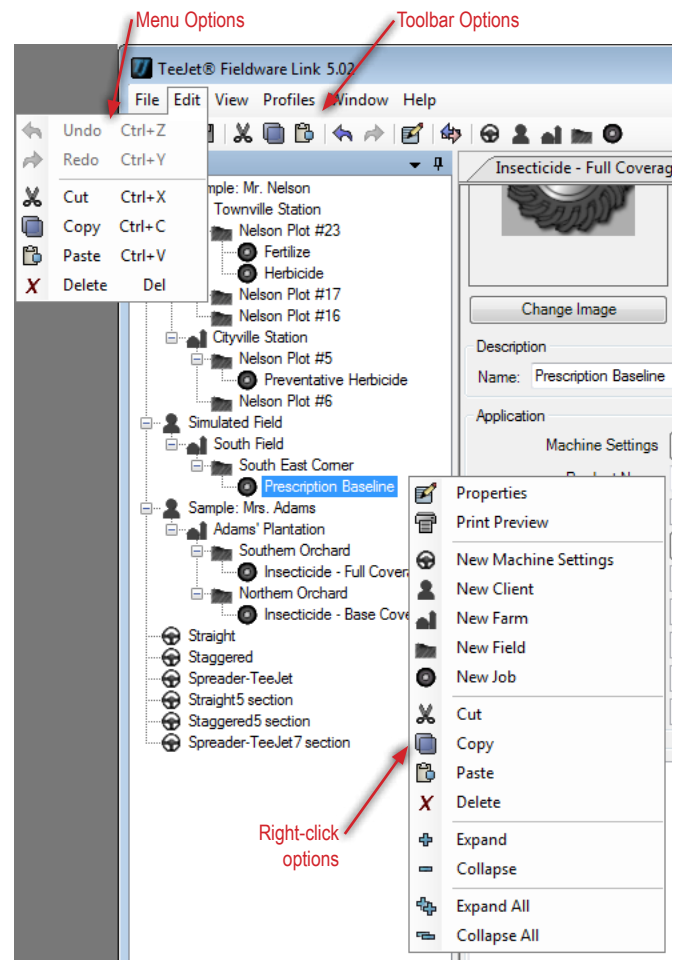

Deleting a Profile

1. Highlight the profile to be deleted in the Catalog
2. Click the Delete **X** menu command, right click in the Catalog or press the Delete button on the keyboard.

NOTE: When deleting a Client, Farm or Field, all sub-elements of these [Farms, Fields or Job] will also be deleted.

Figure 20: Deleting Properties

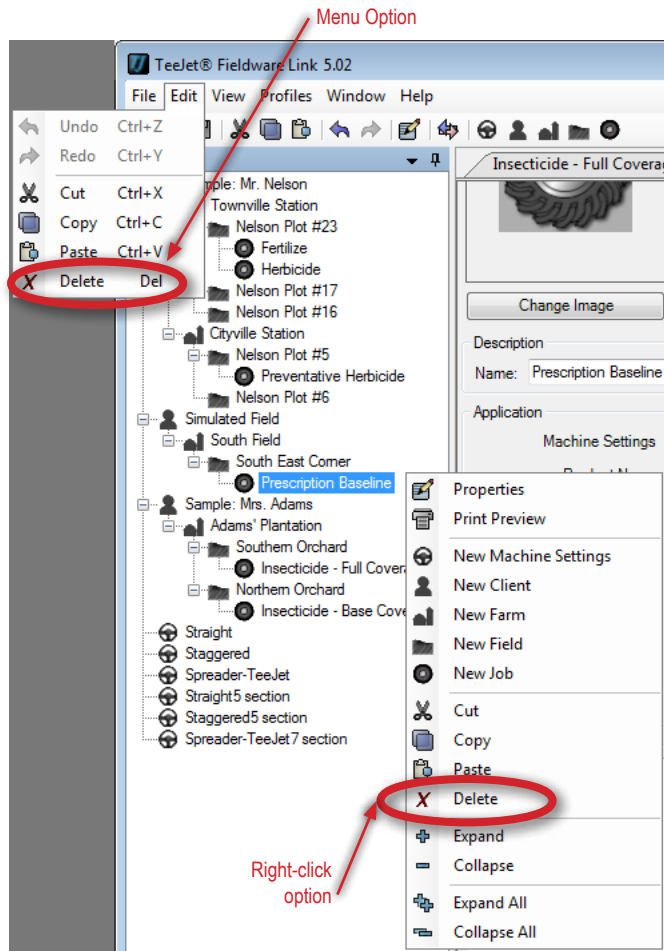

Tabs

Tabs display all open profiles and allow for multiple viewing options.

- ▶ Activate or Inactivate a Profile – click on the desired tab to activate a profile, all other open tabs will become gray indicating they are open but inactive
- ▶ Close an Active Profile – click on the close active tab **X** button or right-click the active tab to close a profile
- ▶ View Tab List – click on the Tab List **☰** button to view all open profiles as a list

Figure 21: Tabs Overview

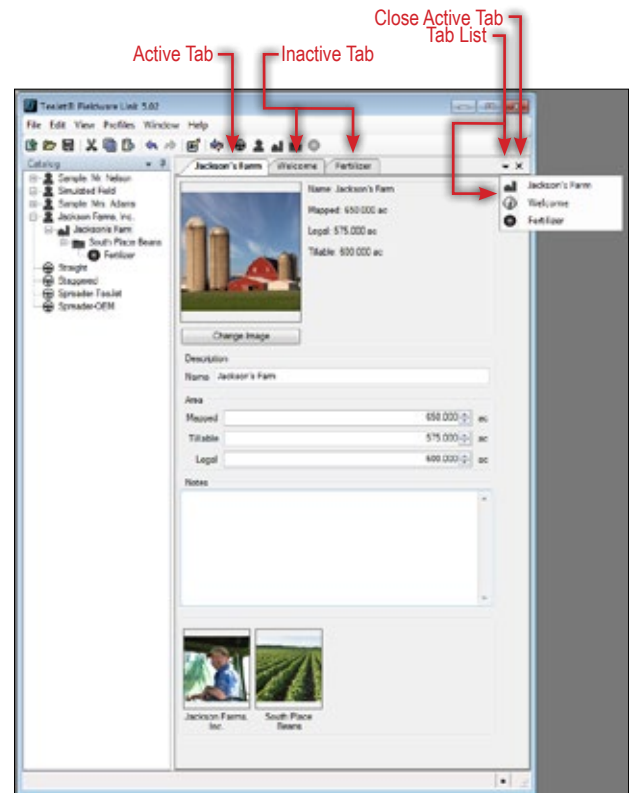

Tab Viewing Options

Dividing the profile pane using tabs allows the user to view multiple profile details at one time.

To divide the profile pane:

1. Click and hold the tab of the selected profile until the Divider icon appears.
2. Drag the tab and release it on the portion of the Divider **+** icon to where the profile is to be moved. The portion of the screen where the profile is being moved to will be highlighted.
3. Release the mouse button and the profile pane will be divided into multiple panes. Repeat as necessary.

Figure 22: Dividing the Profile Pane – Horizontal

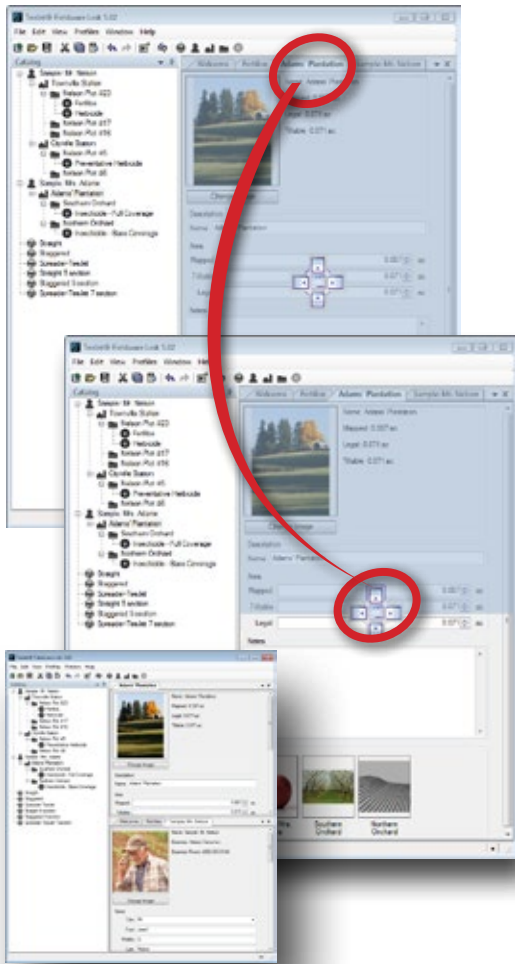
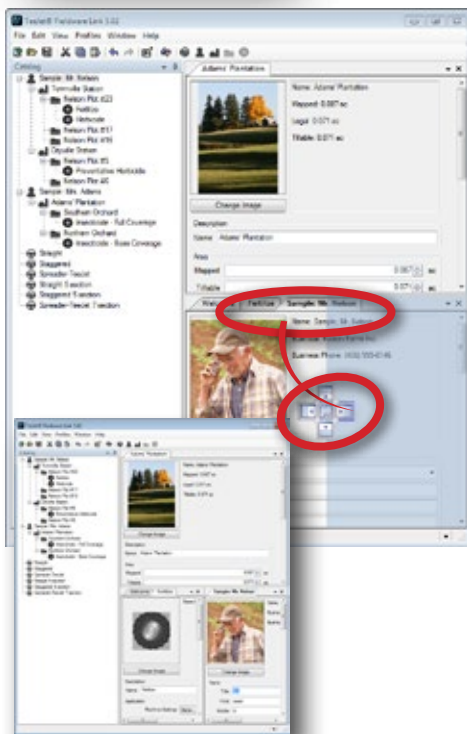

Figure 23: Dividing the Profile Pan – Three ways



To combine tabs into one screen section:

1. Click and hold on tab to be moved.
2. Drag the tab and release it
 - ▶ on the center of the Divider icon
 - ▶ on the tab header

The screen section being combined will be highlighted.

Figure 24: Combine Tabs Into One Screen Section via Divider Icon

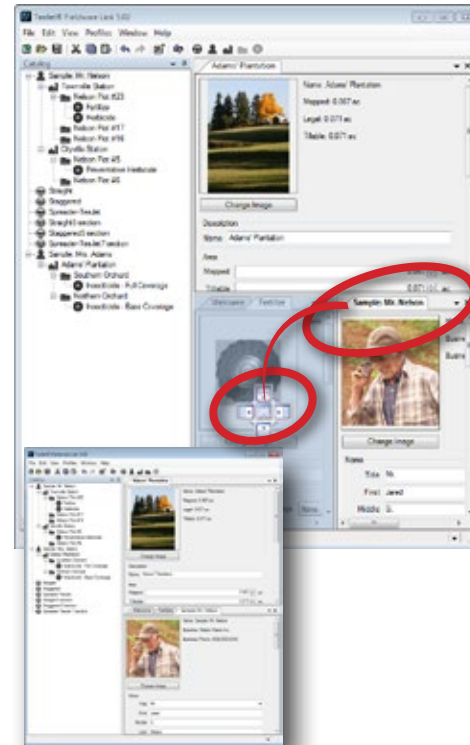
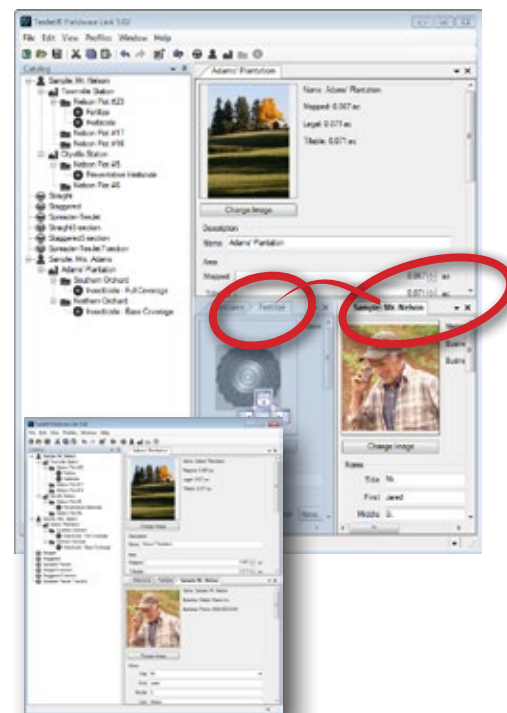

Figure 25: Combine Tabs Into One Screen Section via Tab Header



Setting up Preferences

Fieldware Link is designed to allow users to customize the software. The Options page is where the user can set software preferences for language, units of measurement, messages and recent catalog list.

To set preferences:

1. Open the View menu.
2. Click **Options**.
3. Select from:
 - ▶ Language – set preferred language
* Languages included in the program may be changed at any time.
 - ▶ Units – choose program measurement preference (area, length, weight, pressure, temperature, speed, and volume)
 - ▶ Preferences – define startup options
 - ▶ Messages – reset all suppressed messages (those which have been marked as, “Do not show again”)
 - ▶ Recent Catalog List – establish the number of Catalogs listed in the Recent Catalog List as well as clear Catalog history from the Recent Catalog List

NOTE: Any changes made under the View -> Options menu are considered a global change and not Job specific. Example: if the user changes pressure units from psi to bar, all jobs will be converted to bar until the user makes the change in the View -> Options menu.

NOTE: Any imported job will assume the f

Figure 26: Options Menu

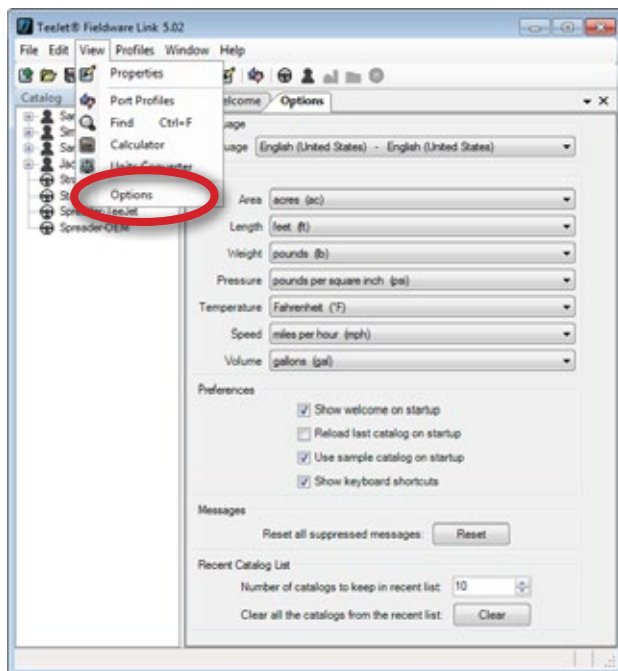

Language Selection

Preferred language can be chosen from either from the Welcome screen or in the Language section on the Options page.

Welcome Screen

1. Click the down arrow ▼ to show list of available languages
2. Select preferred language

Figure 27: Language Selection – Via Welcome Screen

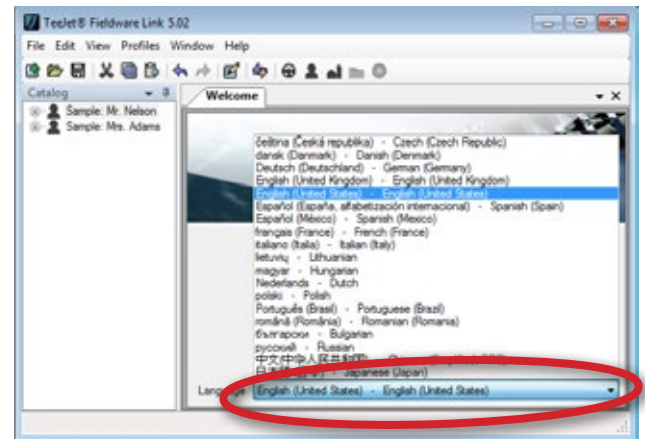

Program Options

1. Select View from the main toolbar menu
2. Click **Options** to open the Options page
3. Click Down arrow ▼ to show list of available languages
4. Select preferred language

Figure 28: Language Selection – Via Options Menu

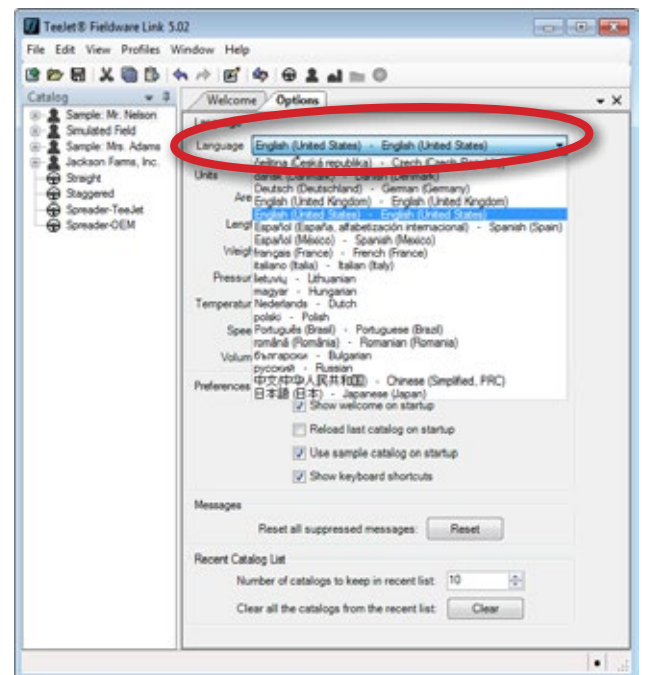

Units of Measurement

Area, length, weight, pressure, temperature, speed, and volume units can be customized by the user.

NOTE: A change in this section will globally change all units of measurement throughout the Catalog.

Figure 29: Units of Measurement Preferences

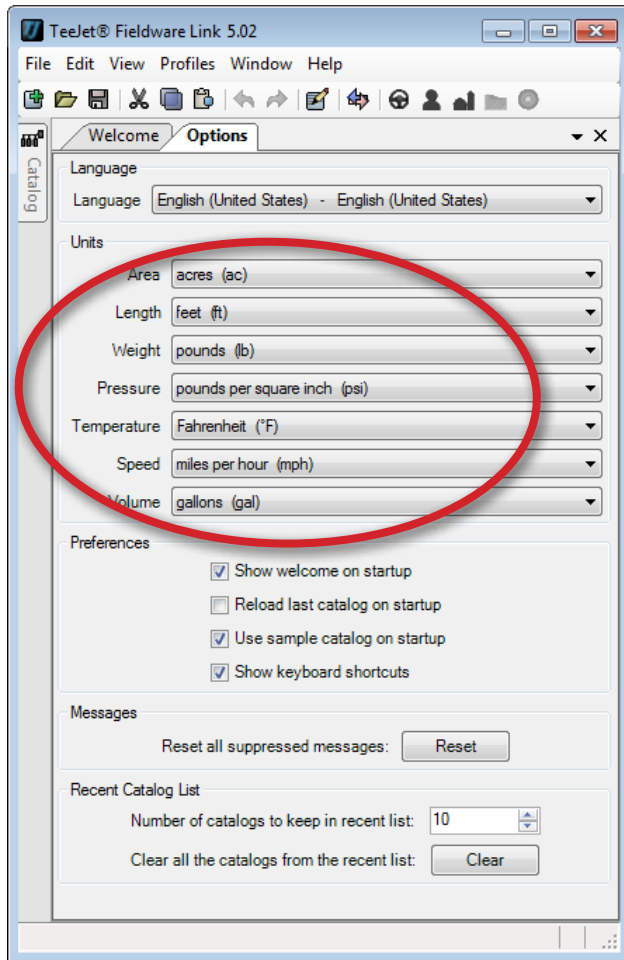

Startup Screen Preferences

A Welcome screen will appear upon startup. Language selection is available on this page.

The Welcome screen can be disabled so it doesn't open upon startup. This option is located under the Preferences section on the Options page. Depending on the user's preference, uncheck or check the Show Welcome on Startup box.

Figure 30: Welcome Screen



Figure 31: Startup Screen Preferences

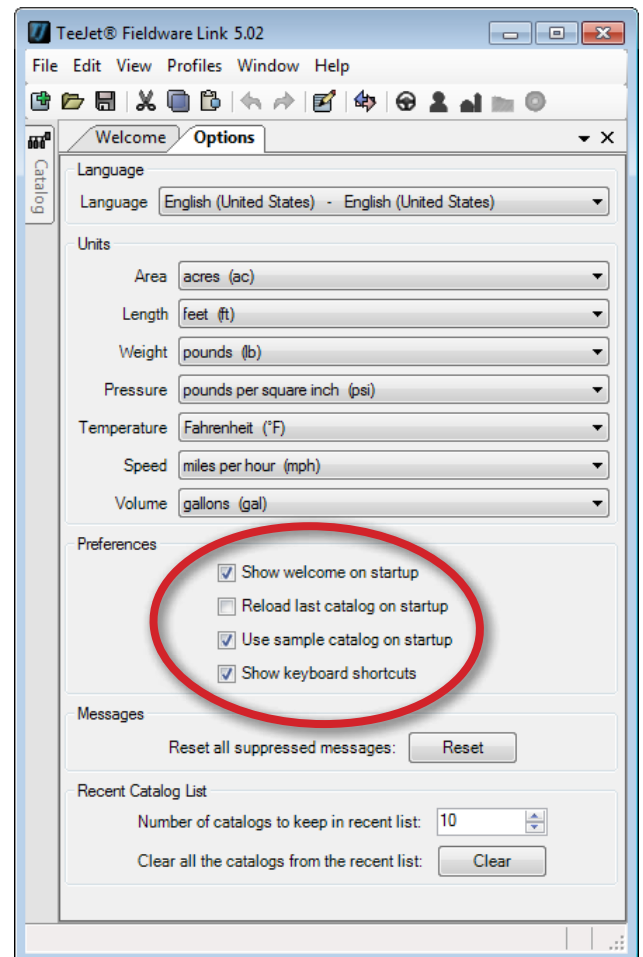

Alert Messages

The user has the option to reset all suppressed messages back to default settings. Suppressed messages are defined as any pop up messages that have been marked as “Do not show again”. Messages preferences can be changed in the Messages section on the Options page.

Figure 32: Messages Preferences

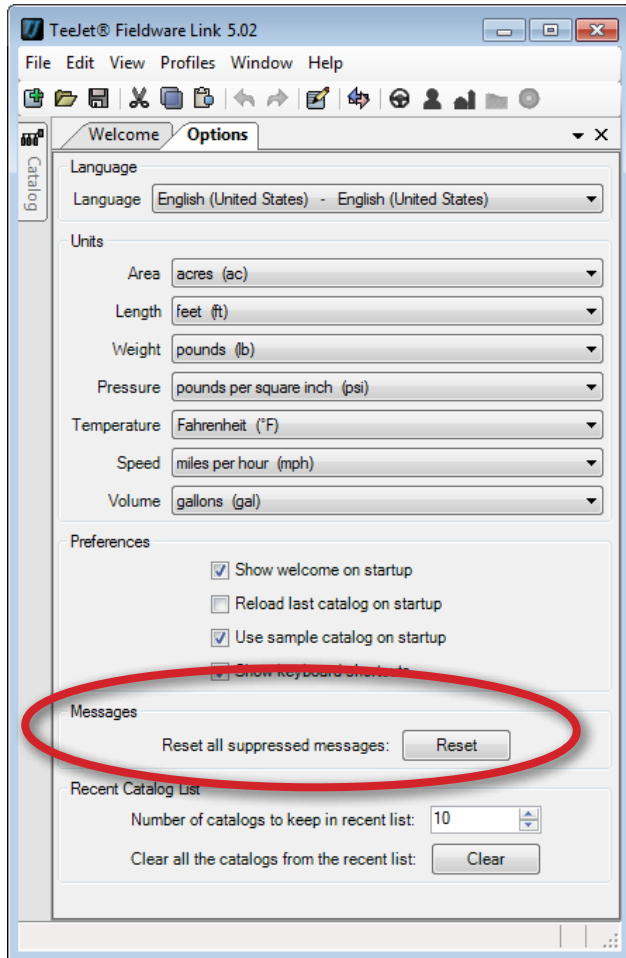

Recent Catalog List

Recent Catalog List provides easy access to the most recently opened files can be accessed under File -> Recent.

To manage Recent Catalog List preferences, navigate to View -> Options -> Recent Catalog List.

- By typing in a number or using the arrow button, the user can choose how many files can be displayed under the File -> Recent menu.
- By clicking the **Clear** button, the user can clear the list of all files shown under File -> Recent.

Figure 33: Managing Recent Catalog List Options

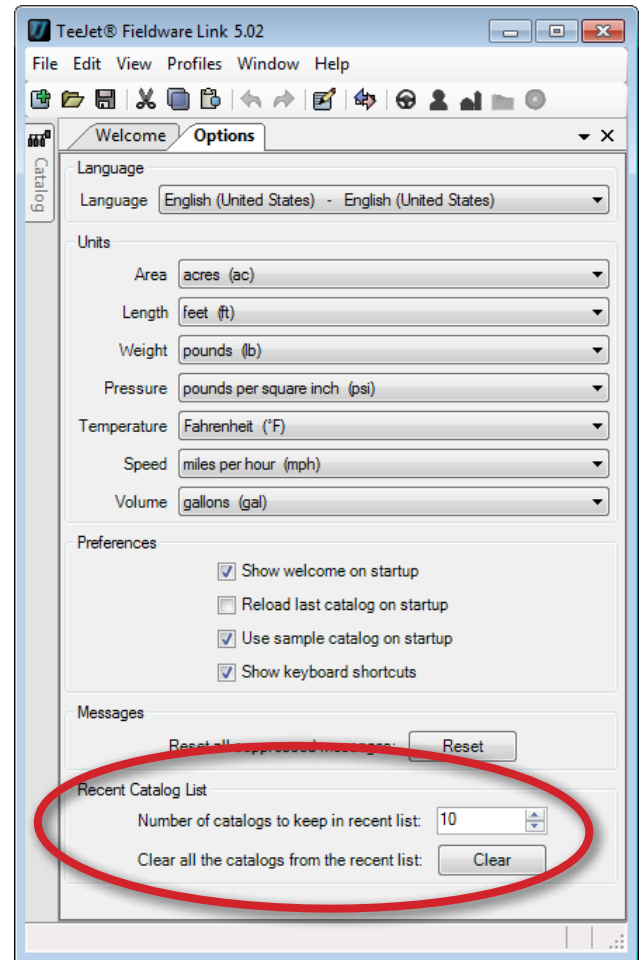

Figure 34: Recent Catalog List

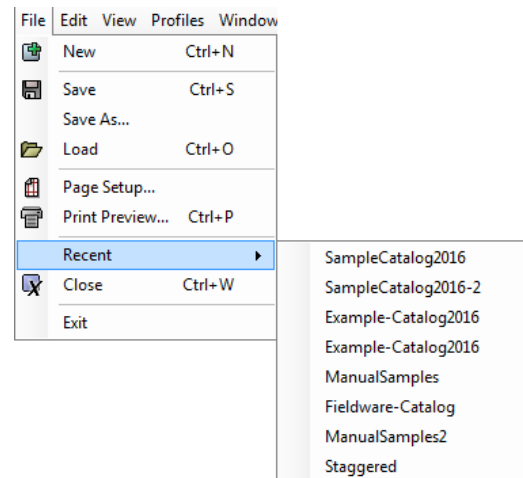
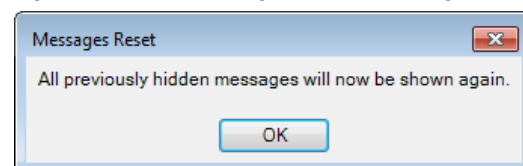

Figure 35: Recent Catalog List Reset Message



WORKING WITH PROFILES

Profiles are records that make up a Catalog. Client, Farm, Field, Job, and Machine Settings are referred to as profiles in Fieldware Link. Profiles are designed for record keeping and job preparation between Fieldware Link and Matrix Pro/Aeros. This section demonstrates how to setup, manage, and utilize profile settings.

CATALOG AND PROFILES

The Catalog is located on the left hand side of the Fieldware Link window. All profiles associated with the open Catalog will be listed in traditional farming hierarchy: Client, Farm, Field, and Job. Machine Settings is also placed at the top hierarchical level. Because a

Machine Settings profile can be applied to multiple Job profiles, it is placed at the same hierarchical level as Client within the Catalog.

Figure 36: Catalog and Profile Hierarchy Example

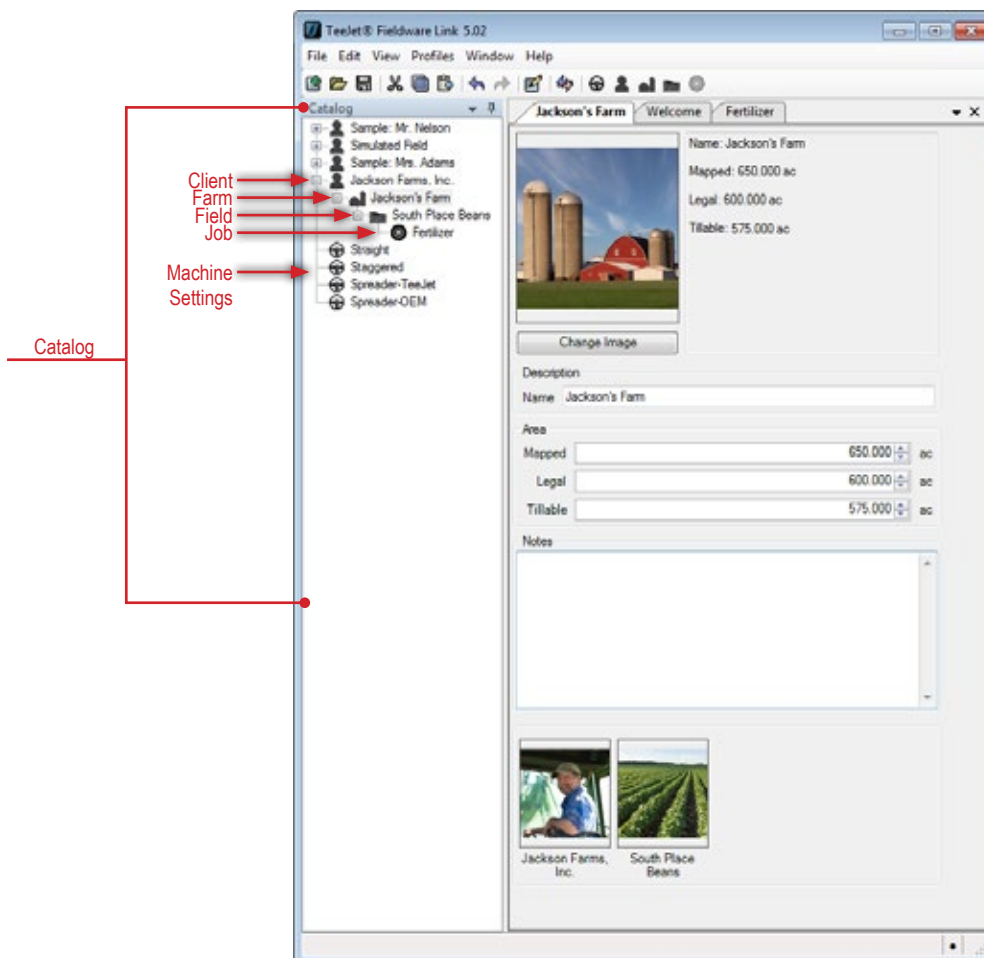

UTILIZING PROFILE RECORDS

● Job Profile

A Job profile stores information that can be transferred to and from the Matrix Pro G, Matrix Pro GS or Aeros console.

- ▶ Profile image and information quick view
- ▶ Description – names the Job profile
 - NOTE: Changing the description of a Job profile does not change how it is recognized by the console.*
- ▶ Application
 - ◀ Machine Settings – a drop down menu of defined Machine Settings Profiles to which the user can choose
 - ◀ Overlap – available only with Machine Settings selected and is pulled from Machine Settings profile
 - ◀ Product Name – a place to track the brand name of product
 - ◀ Tank/Bin Amount – volume of product used on the job
 - ◀ Application Type – enters the type of product to be applied - options are liquid or granular
 - ◀ Target Application Rate Preset – presets application rate for up to three (3) Target Application Rates - range is 0.00 to 100000
 - ◀ Tip Constant – sets an application rate according to the current TeeJet tip – range 0.00 to 100.00
 - ◀ Ground Speed Override (GSO) – sets the minimum speed used for automatic application rate control. When the vehicle speed falls below this setting, GSO speed is used to control the application rate, rather than the actual ground speed - range is 0.00 to 223.69 mph / 0.00 to 360.00 km/h
- ▶ Notes – a place to record specific information not mentioned in the predefined fields
- ▶ Maps and Information – options will appear in this section if applicable to the active job
 - NOTE: For more details on maps, see Application Mapping.*
 - ◀ Boundaries – application boundaries establish areas where product is and is not applied while using ASC or BoomPilot. On the Matrix Pro G, Matrix Pro GS or Aeros console, boundaries can be established in all guidance modes. One exterior boundary and up to five (5) interior boundaries can be stored at one time. A boundary cannot be drawn; it must be established on a console or provided in a third-party prescription map.
 - View** – select to view the boundary(s) on a map and use the Measure Distances tool
 - Delete** – select to delete all boundaries in the current job profile

- ◀ Guidelines – AB guidelines, Azimuth guidelines, next pass guidelines, and NextRow guidelines are each available depending on the current guidance mode on the Matrix Pro G, Matrix Pro GS or Aeros console. Up to 25 established guidelines can be stored in the console per job.
 - Add** – select to open the existing boundary or map in the location of the deleted boundary to add new guideline information
 - Edit** – select to edit an existing guideline(s) on a map or add a straight AB or curved AB guideline(s)
 - Delete** – select to delete all guidelines in the current job profile
- ◀ Prescription Maps – a pre-loaded map that provides information to the rate controller for use in applying product. Prescription Maps contain geo-referenced product rate information. The Aeros console can import job data containing Prescription Maps for use with variable rate application (VRA) using compatible rate controllers.
 - Import** – select to load a new prescription map
 - Add** – select to open the existing boundary to add prescription information to the existing boundary
 - Edit** – select to edit the existing prescription map
 - Delete** – select to delete the existing prescription map
- ◀ Applied Data – applied data is a record of areas covered by the implement and how much and where product has been applied.
 - Export** – select to export the applied data record to an XML file to be used for other external mapping options
 - View** – select to view the applied data on a map and use the Measure Distances tool
 - Delete** – select to delete all applied data in the current job profile
- ◀ Tip Faults – when a Tip Flow Monitor Kit is present on an Aeros system, a Tip Flow Monitor is available. After the tips are balanced, the system will monitor all the tips and their the flow rate if their respective boom section is turned on. The flow rate of each tip must be within the percentage range. If any tip is outside this range, an error will be generated, and the user will need to inspect the tip that is at fault. These faults are recorded and available to be viewed on a map.
 - View** – select to view the tip faults on a map and use the Measure Distances tool
 - Delete** – select to delete all tip faults in the current job profile
- ▶ Associated Profile(s) – displays associated profiles - double-click the image to open the associated profile

Figure 37: Job Profile Sample on Console

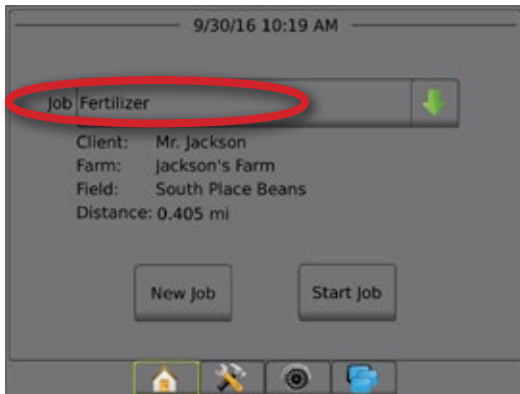

NOTE: While porting information from the software to the console, some information may be stored in the background and not displayed until transferred back into the software.

Figure 38: Job Profile Sample in Fieldware Link

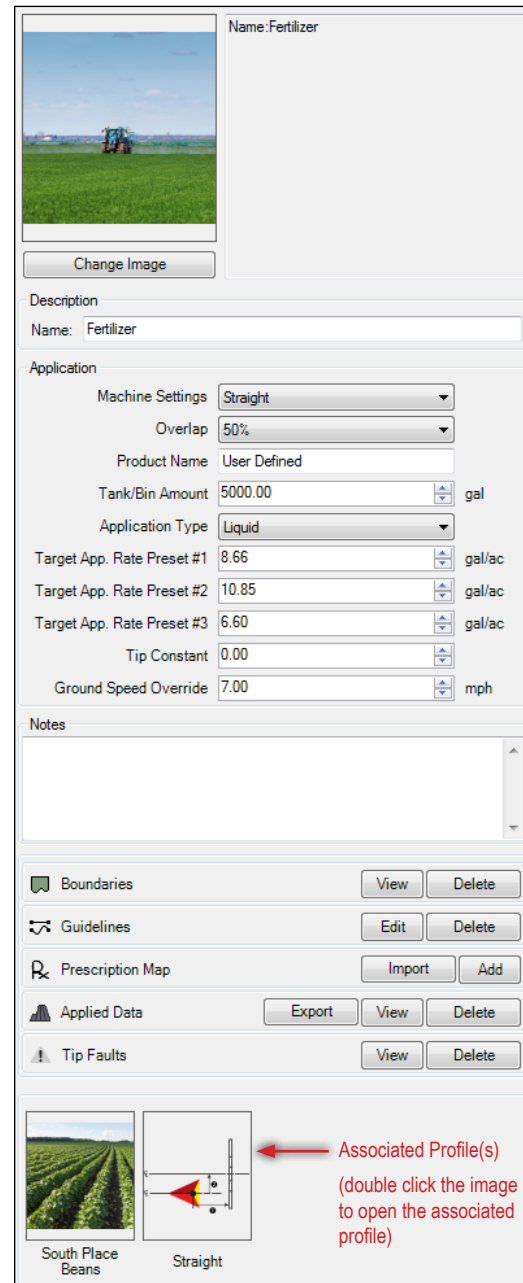



NOTE: Under a Job Profile, the user can delete map information from a specific job, such as Boundaries, Guidelines, Prescription Map, Applied Data, and Tip Faults. The edited job can then be reused by importing back into the supported console.

Duplicating a Job Profile for Reuse

A Job profile can be duplicated for reuse, allowing the user to apply boundary and guideline data from an existing Job profile into a future Job profile within the same field.

To duplicate a Job:

1. On the Catalog, highlight the Job profile.
2. Choose Copy 
3. Choose Paste 
4. Edit the newly created Job profile's description.

NOTE: The copied Job profile retains the original Job name, it is suggested to rename the job indicating duplication (example: JobName_copy).

5. Edit the Application settings as needed.

6. Edit the Maps and Information options including boundaries, guidelines, applied data, prescription maps, and tip faults as needed.
 - ▶ To apply an application to an area more than once using established Boundaries, Guidelines, and Prescription Map, **Delete** the Applied Data and Tip Faults.
 - ▶ To only reuse an established guideline such as an azimuth degree line, **Delete** the Applied Data, Boundaries, Prescription Map, and Tip Faults.
 - ▶ To only reuse an established boundary, **Delete** the Applied Data, Guidelines, Prescription Map, and Tip Faults.
7. Save the Catalog.

Export the duplicated Job to a USB drive for use in the Matrix Pro G, Matrix Pro GS or Aeros console.

Figure 39: Copy and Paste – Toolbar, Menu and Right-Click Options

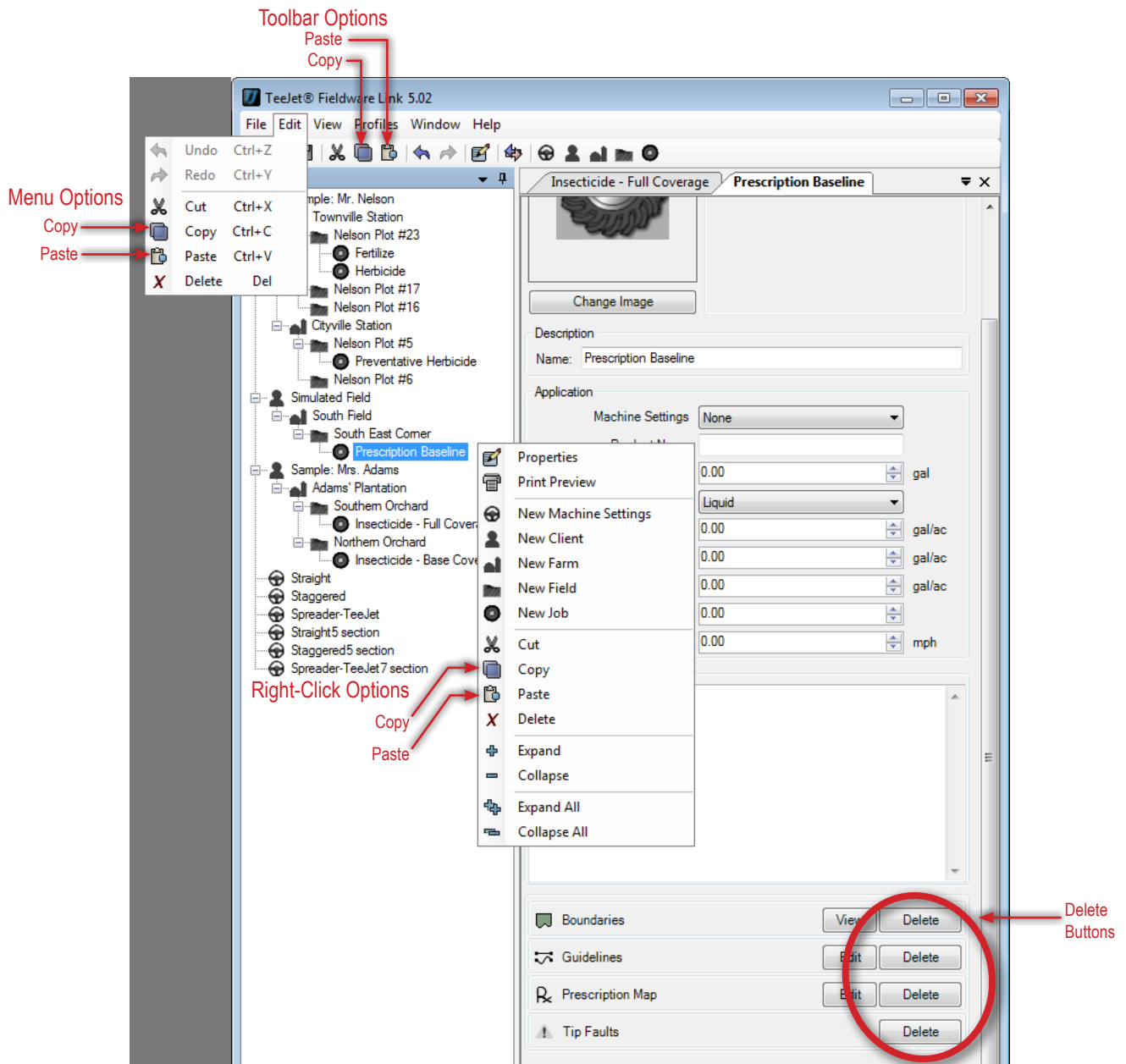

Machine Settings Profile

A Machine Settings profile is used for storing and transferring detailed information about vehicle and implement settings between Fieldware Link and the console. Basic Properties, Implement Dynamics and Job Specific Default entries can be imported from user defined or edited Machine Settings from Aeros or Matrix Pro GS v3.xx and newer console.

Creating a Machine Settings Profile

To create a new Machine Settings profile, either create a copy or a new Machine Settings profile. Changing the description of a Machine Settings profile does not change how a particular Machine Settings profile is recognized by the Aeros, or Matrix Pro GS, console.

NOTE: Because a Machine Settings profile can be applied to multiple Job profiles, it is placed at the same hierarchical level as Client within the Catalog. Machine Settings can be linked to any Job profile by choosing an established Machine Settings profile from the drop down menu on the Job profile screen.

Standard Profile Sections

- ▶ Profile image and information quick view.
- ▶ Basic Properties – defines implement information and measurements.
- ▶ Unit Overrides – defines any measurement units that should vary from those listed in Fieldware Link.
- ▶ Implement Dynamics – depending on Basic Properties section setup, defines specifics for sections and delay on/off times.
- ▶ Job Specific Defaults – defines application specific information.
- ▶ Input Output Module (IOM) Pressure Sensor – defines pressure sensor information.

NOTE: Depending on information entered by the user, available options may vary for Basic Properties, Implement Dynamics and Job Specific Defaults sections.

Figure 40: Machine Settings Profile Sample in Fieldware Link

The screenshot shows the 'Machine Settings Profile' configuration window. At the top left is a diagram of a straight implement section. To its right, the 'Description' is 'Straight-Single Section', 'Implement Type' is 'Straight', 'Number of Implement Sections' is '1', and 'Total Width (ft):' is '10.00'. Below this is a 'Change Image' button. The main area is divided into sections: 'Basic Properties' (Description: Straight-Single Section, GNSS Antenna Height: 12.00 ft, Guidance Width: 50.00 ft, Implement Type: Straight, Lateral Implement Offset Direction: Right, Lateral Implement Offset Distance: 0.00 ft, In-line Implement Offset Direction: Backward, In-line Implement Offset Distance: 10.00 ft, Number of Implement Sections: 1, Tank/Bin Capacity: 1000.00 gal, with checkboxes for Automatic Section Control and Aeros/DCM Rate Contr), 'Unit Overrides' (Volume: gallons (gal)), 'Implement Dynamics' (Symmetric Implement Layout checked, Section Width (ft): 10.00), and 'Job Specific Defaults' (Application Type: Liquid, Target App. Rate Preset #1: 21.40 gal/ac, Target App. Rate Preset #2: 25.80 gal/ac, Target App. Rate Preset #3: 18.70 gal/ac, Tip Constant: 0.00, Ground Speed Override: 7.00 mph). At the bottom is the 'Input Output Module (IOM) Pressure Sensor' section (Maximum Pressure Rating: 145.00 psi, Low Pressure Alarm: 10.00 psi, High Pressure Alarm: 130.00 psi).

Defining Implement Types

Under the Basic Properties section the user defines Implement Type by selecting the type of application pattern that most closely represents the users system.

- ▶ **Straight** – the boom sections have no length and are on a line a fixed distance from antenna
- ▶ **Spreader** – a virtual line is created in line with the delivery disks from which the application section or sections can vary in length and can be at different distances from the line
- ▶ **Staggered** – a virtual line is created in line with section one (1) from which the application section or sections have no length and can be at different distances from the line

Sections are numbered from left to right while facing in the machine's forward direction.

Figure 41: Implement Type – Straight

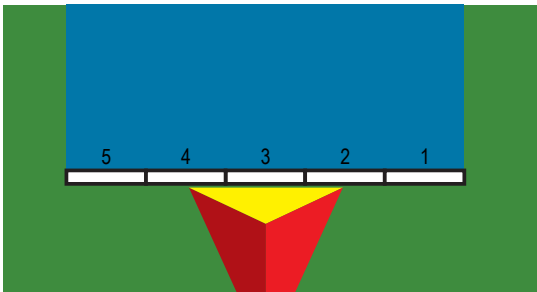

Figure 42: Implement Type – Spreader

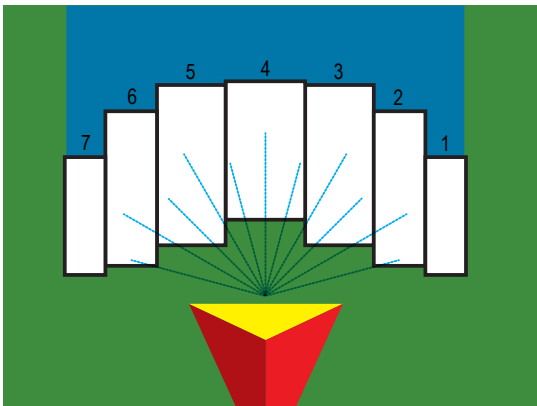
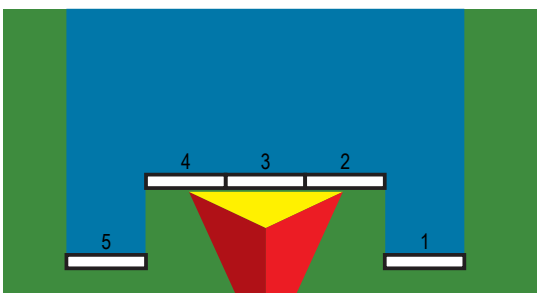

Figure 43: Implement Type – Staggered



Straight Implement Type

Basic Properties

- ▶ **Description** – names the Machine Settings profile
- ▶ **GNSS Antenna Height** – measures the antenna height from the ground - range is 0.0 to 32.81 feet / 0.0 to 10.0 meters
- ▶ **Guidance Width** – enters the distance between the guidelines - range is 3.28 to 246.06 feet / 1.0 to 75.0 meters
- ▶ **Implement Type** – selects **Straight** as the layout of the sections for the applied product location
- ▶ **Lateral Implement Offset Direction ②** – selects the lateral direction (left or right) from the centerline of the machine to the center of the implement while facing in the machine's forward direction
- ▶ **Lateral Implement Offset Distance ②** – defines the lateral distance from the centerline of the machine to the center of the implement - range is 0.00 to 164.04 feet / 0.00 to 50.00 meters
- ▶ **In-line Implement Offset Direction ①** – selects whether the implement is located in front of or behind the GNSS antenna as the vehicle moves in a forward direction
- ▶ **In-line Implement Offset Distance ①** – defines the in-line distance from the GNSS antenna to the implement – range is 0.00 to 164.04 feet / 0.00 to 50.00 meters
- ▶ **Number of Implement Sections** – selects the number of implement sections – range is 1 to 15 sections
- ▶ **Tank/Bin Capacity** – enters the capacity of the tank or bin - range is 0.00 to 264,172.052 gallons / 0.00 to 1,000,000.00 liters
- ▶ **Automatic Section Control (ASC)** – when enabled, Delay Time options, and Overlap percentage options become available
- ▶ **Aeros/DCM Rate Control** – when enabled, rate controller options become available

Figure 44: Implement Offset Distance and Direction

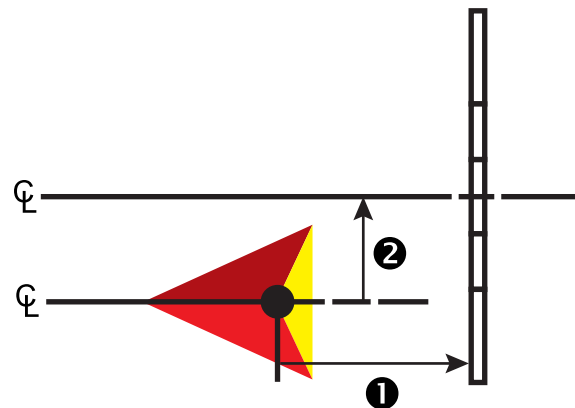

Unit Overrides

- ▶ Volume – selects unit of measurement to override the volume units from Fieldware Link options. This override only affects this Machine Settings profile

Implement Dynamics

- ▶ Delay On Time [when ASC is enabled] – used to set the time when the section will switch on when entering an area that has not been applied - range is 0 to 10 seconds

NOTE: If the application turns on too soon when entering an unapplied area, decrease the Delay On time. If the application turns on too late, increase the Delay On time.

- ▶ Delay Off Time [when ASC is enabled] – used to set the time when the section will switch off when entering an area that has been applied - range is 0 to 10 seconds

NOTE: If the application turns off too soon when entering an unapplied area, decrease the Delay Off time. If the application turns off too late, increase the Delay Off time.

- ▶ Symmetric Implement Layout – used to establish if sections are paired and therefore share the same Section Width values
- ▶ Section Width – used to enter the width of each section of the implement. Each section can be a different width – range for each section is 0.0 to 246.06 feet / 0.0 to 75.0 meters

NOTE: Total for all sections must be greater than 3.28 feet / 1.0 meter

NOTE: Sections are numbered from left to right while facing in the machine's forward direction.

Job Specific Defaults

- ▶ Overlap [when ASC is enabled] – selects the amount of overlap allowed when the sections are turned on and off - options are 0%, 50%, and 100%

Figure 45: Overlap Illustration for Straight Implement Type

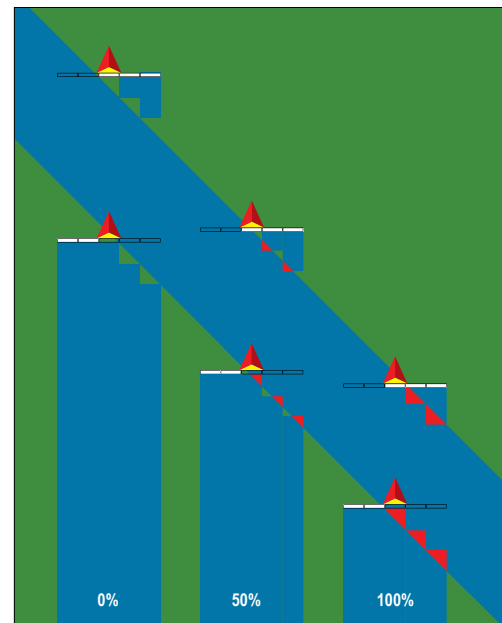

- ▶ Application Type – enters the type of product to be applied - options are liquid or granular
- ▶ Target Application Rate Preset – presets application rate for up to three (3) Target Application Rates - range is 0.00 to 100000
- ▶ Tip Constant – sets an application rate according to the current TeeJet tip – range 0.00 to 100.00
- ▶ Ground Speed Override (GSO) – sets the minimum speed used for automatic application rate control. When the vehicle speed falls below this setting, GSO speed is used to control the application rate, rather than the actual ground speed - range is 0.00 to 223.69 mph / 0.00 to 360.00 km/h

Input Output Module (IOM) Pressure Sensor

- ▶ Maximum Pressure Rating – used to establish the maximum pressure rating of the pressure sensor as recommended by the manufacturer - range is 1.45 to 435.11 psi / 0.00 to 30.00 bar
- ▶ Low Pressure Alarm – used to enter the user determined low pressure point at which the alarm will sound - range is 0.00 to 1450.38 psi / 0.00 to 100.00 bar
- ▶ High Pressure Alarm – used to enter the user determined high pressure point at which the alarm will sound - range is 0.00 to 1450.38 psi / 0.00 to 100.00 bar

Figure 46: Straight Implement Type

Description: Straight
 Implement Type: Straight
 Number of Implement Sections: 5
 Total Width (ft): 50.00

Basic Properties

Description:

GNSS Antenna Height: ft

Guidance Width: ft

Implement Type:

Lateral Implement Offset Direction:

Lateral Implement Offset Distance: ft

In-line Implement Offset Direction:

In-line Implement Offset Distance: ft

Number of Implement Sections:

Tank/Bin Capacity: gal

Automatic Section Control Aeros/DCM Rate Contr

Unit Overrides

Volume:

Implement Dynamics

Delay On Time: sec

Delay Off Time: sec

Symmetric Implement Layout

Section Width (ft)

1	<input type="text" value="10.00"/>
2	<input type="text" value="10.00"/>
3	<input type="text" value="10.00"/>
4	<input type="text" value="10.00"/>
5	<input type="text" value="10.00"/>

Job Specific Defaults

Overlap:

Application Type:

Target App. Rate Preset #1: gal/ac

Target App. Rate Preset #2: gal/ac

Target App. Rate Preset #3: gal/ac

Tip Constant:

Ground Speed Override: mph

Input Output Module (IOM) Pressure Sensor

Maximum Pressure Rating: psi

Low Pressure Alarm: psi

High Pressure Alarm: psi

Spreader Implement Type – TeeJet Option

NOTE: When loading this profile type onto a console without a Smartcable or SDM on the system, only values for Section 1 will be used. All other section or ASC information will be retained in the background as unused parts of the profile.

Loading a spreader implement type onto a console that has not had the spreader ASC feature unlocked is not permitted.

The machine settings for multiple-section spreader applications are machine dependent. Please consult with the spreader manufacturer, and not TeeJet, for these machine specific settings.

Basic Properties

- ▶ Description – names the Machine Settings profile
- ▶ GNSS Antenna Height – measures the antenna height from the ground - range is 0.0 to 32.81 feet / 0.0 to 10.0 meters
- ▶ Guidance Width – enters the distance between the guidelines - range is 3.28 to 246.06 feet / 1.0 to 75.0 meters
- ▶ Implement Type – used to select **Spreader** as the layout of the sections for the applied product location
- ▶ Lateral Implement Offset Direction **2** – selects the lateral direction (left or right) from the centerline of the machine to the center of the implement while facing in the machine's forward direction
- ▶ Lateral Implement Offset Distance **2** – defines the lateral distance from the centerline of the machine to the center of the implement - range is 0.00 to 164.04 feet / 0.00 to 50.00 meters
- ▶ Antenna to Disks Distance **1** – enters the distance from the GNSS antenna to the delivery disks or dispersal mechanism – range is 0.0 to 164.04 feet / 0.0 to 50.0 meters
- ▶ Number of Implement Sections – selects the number of implement sections – range is 1 to 15 sections
- ▶ Tank/Bin Capacity – enters the capacity of the tank or bin - range is 0.00 to 264,172.052 gallons / 0.00 to 1,000,000.00 liters
- ▶ Automatic Section Control (ASC) – when enabled, Delay Time options, and Overlap percentage options become available
- ▶ Aeros/DCM Rate Control – when enabled, rate controller options become available

Unit Overrides

- ▶ Volume – selects unit of measurement to override the volume units from Fieldware Link options. This override only affects this Machine Settings profile

Figure 47: Lateral Offset Direction and Distance – Single Section

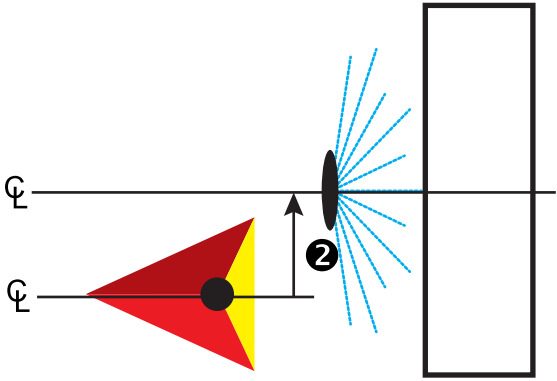
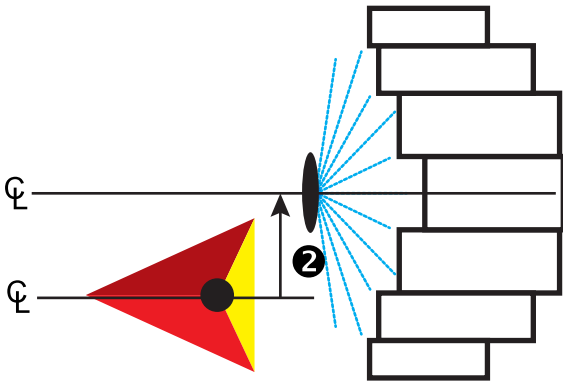

Figure 48: Lateral Offset Direction and Distance – Multiple Section



Implement Dynamics

- ▶ Setup Type – used to select either TeeJet spreader type
- ▶ Delay On Time [when ASC is enabled] – used to set the time when the section will switch on when entering an area that has not been applied - range is 0 to 10 seconds

NOTE: If the application turns on too soon when entering an unapplied area, decrease the Delay On time. If the application turns on too late, increase the Delay On time.

- ▶ Delay Off Time [when ASC is enabled] – used to set the time when the section will switch off when entering an area that has been applied - range is 0 to 10 seconds

NOTE: If the application turns off too soon when entering an unapplied area, decrease the Delay Off time. If the application turns off too late, increase the Delay Off time.

- ▶ Spread Offset Distance ③ – used to set the distance between the disks or dispersal mechanism and where product initially hits the ground on Section 1 – range is 0.0 to 246.06 feet / 0.0 to 75.0 meters
- ▶ Symmetric Implement Layout – establishes if sections are paired and therefore share the same Section Width, Section Offsets, and Section Lengths values.

- ▶ Section Width – enters the width of each section of the implement – range for each section is 0.0 to 246.06 feet / 0.0 to 75.0 meters

NOTE: Total for all sections must be greater than 3.28 feet / 1.0 meter. Each section can be a different width.

NOTE: Sections are numbered from left to right while facing in the machine's forward direction.

- ▶ Section Lengths ⑤ – used to set the length of application in each section – range for each section is 0.0 to 246.06 feet / 0.0 to 75.0 meters.

NOTE: Each section can be a different length.

NOTE: Sections are numbered from left to right while facing in the machine's forward direction.

- ▶ Section Offsets ④ – used to set the offset distance from Section 1 (the Spread Offset line) to the leading edge of each section, Section 1 is always 0, all other sections can be different distances

NOTE: The Section Offsets option is only available when multiple sections are engaged.

Figure 49: Distances and Length – Single Section

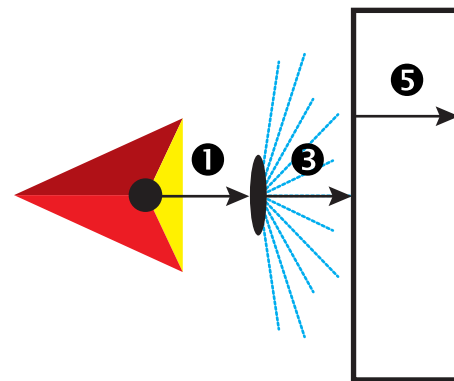
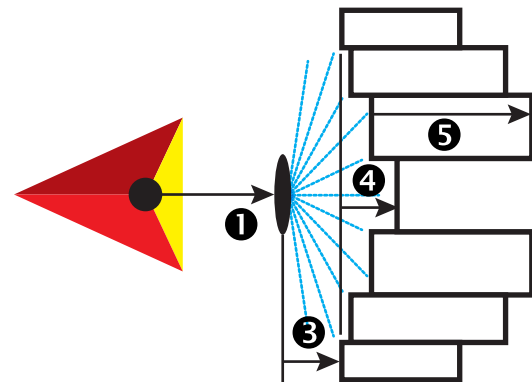

Figure 50: Distances and Length – Multiple Section



Job Specific Defaults

- ▶ Overlap [when ASC is enabled] – selects the amount of overlap allowed when the sections are turned on and off - options are 0%, 50%, and 100%

Figure 51: Overlap Illustration for Spreader Implement Type

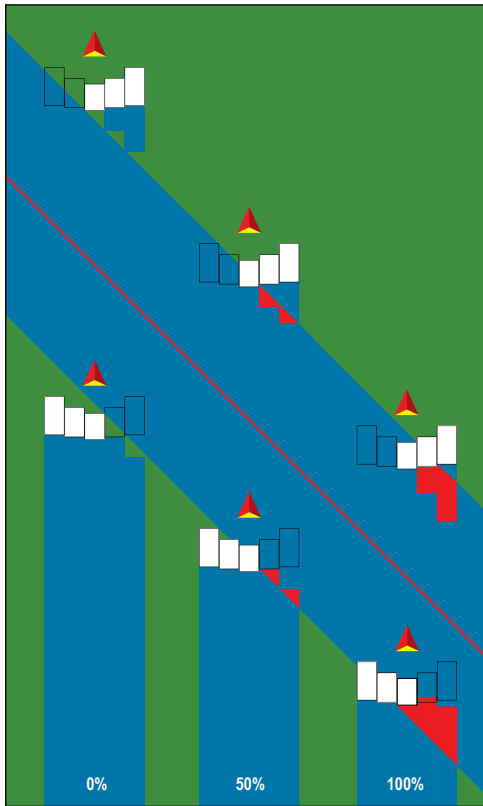

- ▶ Application Type – enters the type of product to be applied - options are liquid or granular
- ▶ Target Application Rate Preset – presets application rate for up to three (3) Target Application Rates - range is 0.00 to 100000
- ▶ Tip Constant – sets an application rate according to the current TeeJet tip – range 0.00 to 100.00
- ▶ Ground Speed Override (GSO) – sets the minimum speed used for automatic application rate control - when the vehicle speed falls below this setting, GSO speed is used to control the application rate, rather than the actual ground speed - range is 0.00 to 223.69 mph / 0.00 to 360.00 km/h

Input Output Module (IOM) Pressure Sensor

- ▶ Maximum Pressure Rating – used to establish the maximum pressure rating of the pressure sensor as recommended by the manufacturer - range is 1.45 to 435.11 psi / 0.00 to 30.00 bar
- ▶ Low Pressure Alarm – used to enter the user determined low pressure point at which the alarm will sound - range is 0.00 to 1450.38 psi / 0.00 to 100.00 bar

- ▶ High Pressure Alarm – used to enter the user determined high pressure point at which the alarm will sound - range is 0.00 to 1450.38 psi / 0.00 to 100.00 bar

Figure 52: Spreader Implement Type

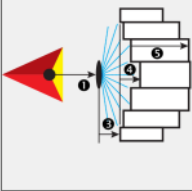

Change Image

Description: Spreader-TeeJet
 Implement Type: Spreader
 Number of Implement Sections: 7
 Total Width (ft): 23.00

Basic Properties

Description: Spreader-TeeJet

GNSS Antenna Height: 5.00 ft

Guidance Width: 60.00 ft

Implement Type: Spreader

Lateral Implement Offset Direction: Right

Lateral Implement Offset Distance: 0.00 ft

Antenna to Disks Distance: 10.00 ft

Number of Implement Sections: 7

Tank/Bin Capacity: 0.00 gal

Automatic Section Control Aeros/DCM Rate Contr

Unit Overrides

Volume: gallons (gal)

Implement Dynamics

Setup Type: TeeJet

Delay On Time: 2.00 sec

Delay Off Time: 2.00 sec

Spread Offset Distance: 4.50 ft

Symmetric Implement Layout

	Section Width (ft)	Section Lengths (ft)	Section Offsets (ft)
1	2.00	4.00	0.00
2	3.00	5.00	0.50
3	4.00	5.00	1.00
4	5.00	4.00	2.00
5	4.00	5.00	1.00
6	3.00	5.00	0.50
7	2.00	4.00	0.00

Job Specific Defaults

Overlap: 50%

Application Type: Granular

Target App. Rate Preset #1: 0.00 lb/ac

Target App. Rate Preset #2: 0.00 lb/ac

Target App. Rate Preset #3: 0.00 lb/ac

Tip Constant: 0.00

Ground Speed Override: 7.00 mph

Input Output Module (IOM) Pressure Sensor

Maximum Pressure Rating: 1.45 psi

Low Pressure Alarm: 0.00 psi

High Pressure Alarm: 0.00 psi

Spreader Implement Type – OEM

Basic Properties

- ▶ Description – names the Machine Settings profile
- ▶ GNSS Antenna Height – measures the antenna height from the ground - range is 0.0 to 32.81 feet / 0.0 to 10.0 meters
- ▶ Guidance Width – enters the distance between the guidelines - range is 3.28 to 246.06 feet / 1.0 to 75.0 meters
- ▶ Implement Type – selects **Spreader** as the layout of the sections for the applied product location
- ▶ Lateral Implement Offset Direction **2** – selects the lateral direction (left or right) from the centerline of the machine to the center of the implement while facing in the machine's forward direction
- ▶ Lateral Implement Offset Distance **2** – defines the lateral distance from the centerline of the machine to the center of the implement - range is 0.00 to 164.04 feet / 0.00 to 50.00 meters
- ▶ Antenna to Disks Distance – enters the distance from the GNSS antenna to the delivery disks or dispersal mechanism - range is 0.0 to 164.04 feet / 0.0 to 50.0 meters
- ▶ Number of Implement Sections – selects the number of implement sections – range is 1 to 15 sections
- ▶ Tank/Bin Capacity – enters the capacity of the tank or bin - range is 0.00 to 264,172.052 gallons / 0.00 to 1,000,000.00 liters
- ▶ Automatic Section Control (ASC) – when enabled, Delay Time options, and Overlap percentage options become available
- ▶ Aeros/DCM Rate Control – when enabled, rate controller options become available

Unit Overrides

- ▶ Volume – selects unit of measurement to override the volume units from Fieldware Link options. This override only affects this Machine Settings profile

Implement Dynamics

- ▶ Setup Type – selects **OEM** spreader type
- ▶ Start Distance – sets the start distance when exiting an applied area (consult spreader manufacturer for value)
- ▶ Stop Distance – sets the stop distance when entering an applied area
NOTE: Consult spreader manufacturer for start and stop distances.
- ▶ Symmetric Implement Layout – used to establish if sections are paired and therefore share the same Section Width, Section Offsets, and Section Lengths values

- ▶ Section Width – used to enter the width of each section of the implement – range for each section is 0.0 to 246.06 feet / 0.0 to 75.0 meters

NOTE: Total for all sections must be greater than 3.28 feet / 1.0 meter. Each section can be a different width.

NOTE: Sections are numbered from left to right while facing in the machine's forward direction.

- ▶ Section Start Offsets – sets the offset distance from Section 1 to the leading edge of each section, Section 1 is always 0 - all other sections can be different distances
- ▶ Section Stop Offsets – sets the offset distance from Section 1 to the trailing edge of each section - each section can be a different distance

NOTE: Consult spreader manufacturer for section start and stop offset values. Sections are numbered from left to right while facing in the machine's forward direction.

Job Specific Defaults

- ▶ Overlap [when ASC is enabled] – selects the amount of overlap allowed when the sections are turned on and off - options are 0%, 50%, and 100%
- ▶ Application Type – enters the type of product to be applied - options are liquid or granular
- ▶ Target Application Rate Preset – presets application rate for up to three (3) Target Application Rates - range is 0.00 to 100000
- ▶ Tip Constant – sets an application rate according to the current TeeJet tip – range 0.00 to 100.00
- ▶ Ground Speed Override (GSO) – sets the minimum speed used for automatic application rate control - when the vehicle speed falls below this setting, GSO speed is used to control the application rate, rather than the actual ground speed - range is 0.00 to 223.69 mph / 0.00 to 360.00 km/h

Input Output Module (IOM) Pressure Sensor

- ▶ Maximum Pressure Rating – used to establish the maximum pressure rating of the pressure sensor as recommended by the manufacturer - range is 1.45 to 435.11 psi / 0.00 to 30.00 bar
- ▶ Low Pressure Alarm – used to enter the user determined low pressure point at which the alarm will sound - range is 0.00 to 1450.38 psi / 0.00 to 100.00 bar
- ▶ High Pressure Alarm – used to enter the user determined high pressure point at which the alarm will sound - range is 0.00 to 1450.38 psi / 0.00 to 100.00 bar

Figure 53: Spreader Implement Type – OEM

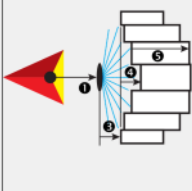

Description: Spreader-TeeJet

Implement Type: Spreader

Number of Implement Sections: 7

Total Width (ft): 23.00

Change Image

Basic Properties

Description:

GNSS Antenna Height: ft

Guidance Width: ft

Implement Type:

Lateral Implement Offset Direction:

Lateral Implement Offset Distance: ft

Antenna to Disks Distance: ft

Number of Implement Sections:

Tank/Bin Capacity: gal

Automatic Section Control Aeros/DCM Rate Contr

Unit Overrides

Volume:

Implement Dynamics

Setup Type:

Delay On Time: sec

Delay Off Time: sec

Spread Offset Distance: ft

Symmetric Implement Layout

Section	Section Width (ft)	Section Lengths (ft)	Section Offsets (ft)
1	<input type="text" value="2.00"/>	<input type="text" value="4.00"/>	<input type="text" value="0.00"/>
2	<input type="text" value="3.00"/>	<input type="text" value="5.00"/>	<input type="text" value="0.50"/>
3	<input type="text" value="4.00"/>	<input type="text" value="5.00"/>	<input type="text" value="1.00"/>
4	<input type="text" value="5.00"/>	<input type="text" value="4.00"/>	<input type="text" value="2.00"/>
5	<input type="text" value="4.00"/>	<input type="text" value="5.00"/>	<input type="text" value="1.00"/>
6	<input type="text" value="3.00"/>	<input type="text" value="5.00"/>	<input type="text" value="0.50"/>
7	<input type="text" value="2.00"/>	<input type="text" value="4.00"/>	<input type="text" value="0.00"/>

Job Specific Defaults

Overlap:

Application Type:

Target App. Rate Preset #1: lb/ac

Target App. Rate Preset #2: lb/ac

Target App. Rate Preset #3: lb/ac

Tip Constant:

Ground Speed Override: mph

Input Output Module (IOM) Pressure Sensor

Maximum Pressure Rating: psi

Low Pressure Alarm: psi

High Pressure Alarm: psi

Staggered Implement Type

NOTE: When loading this profile type onto a console without a Smartcable or SDM on the system, only values for Section 1 will be used and the implement type will be set to "Straight". All other section or ASC information will be retained in the background as unused parts of the profile.

Basic Properties

- ▶ Description – names the Machine Settings profile
- ▶ GNSS Antenna Height – measures the antenna height from the ground - range is 0.0 to 32.81 feet / 0.0 to 10.0 meters
- ▶ Guidance Width – enters the distance between the guidelines - range is 3.28 to 246.06 feet / 1.0 to 75.0 meters
- ▶ Implement Type – selects **Staggered** as the layout of the sections for the applied product location.
- ▶ Lateral Implement Offset Direction ② – selects the lateral direction (left or right) from the centerline of the machine to the center of the implement while facing in the machine's forward direction
- ▶ Lateral Implement Offset Distance ② – defines the lateral distance from the centerline of the machine to the center of the implement - range is 0.00 to 164.04 feet / 0.00 to 50.00 meters
- ▶ In-line Section 1 Offset Direction ① – selects whether Section 1 (the zero-point of the Section Offsets) is located in front of or behind the GNSS antenna as the vehicle moves in a forward direction
- ▶ In-line Section 1 Offset Distance ① – defines the in-line distance from the GNSS antenna to Section 1 (the zero-point of the Section Offsets)
- ▶ Number of Implement Sections – selects the number of implement sections – range is 1 to 15 sections
- ▶ Tank/Bin Capacity – enters the capacity of the tank or bin - range is 0.00 to 264,172.052 gallons / 0.00 to 1,000,000.00 liters

Figure 54: Offset Directions and Distances – in front of section 1

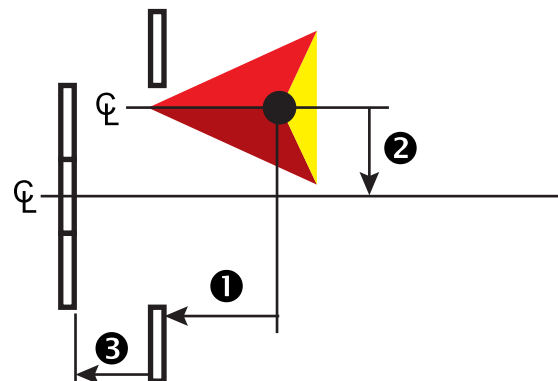
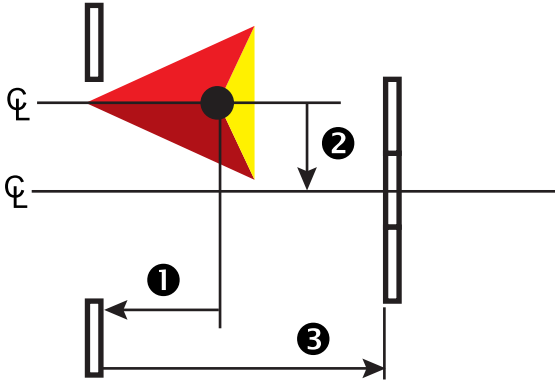

Figure 55: Offset Directions and Distances – behind section 1



Unit Overrides

- Volume – selects unit of measurement to override the volume units from Fieldware Link options. This override only affects this Machine Settings profile

Implement Dynamics

- Delay On Time [when ASC is enabled] – used to set the time when the section will switch on when entering an area that has not been applied - range is 0 to 10 seconds

NOTE: If the application turns on too soon when entering an unapplied area, decrease the Delay On time. If the application turns on too late, increase the Delay On time.

- Delay Off Time [when ASC is enabled] – used to set the time when the section will switch off when entering an area that has been applied - range is 0 to 10 seconds

NOTE: If the application turns off too soon when entering an unapplied area, decrease the Delay Off time. If the application turns off too late, increase the Delay Off time.

- Symmetric Implement Layout – used to establish if sections are paired and therefore share the same Section Width and Section Offsets values
- Section Width – used to enter the width of each section of the implement – range for each section is 0.0 to 246.06 feet/ 0.0 to 75.0 meters

NOTE: Total for all sections must be greater than 3.28 feet / 1.0 meters. Each section can be a different width.

NOTE: Sections are numbered from left to right while facing in the machine's forward direction.

- Section Offsets (E) – used to set the offset distance from Section 1 (the In-Line Section 1 Offset Distance line) to each section. A positive offset value will move the section behind Section 1. A negative offset value will move the section in front of Section 1. Section 1 is always 0. All other sections can be different distances.

NOTE: The Section Offsets option is only available when multiple sections are engaged.

Job Specific Defaults

- Overlap [when ASC is enabled] – selects the amount of overlap allowed when the sections are turned on and off - options are 0%, 50%, and 100%

Figure 56: Overlap Illustration for Staggered Implement Type

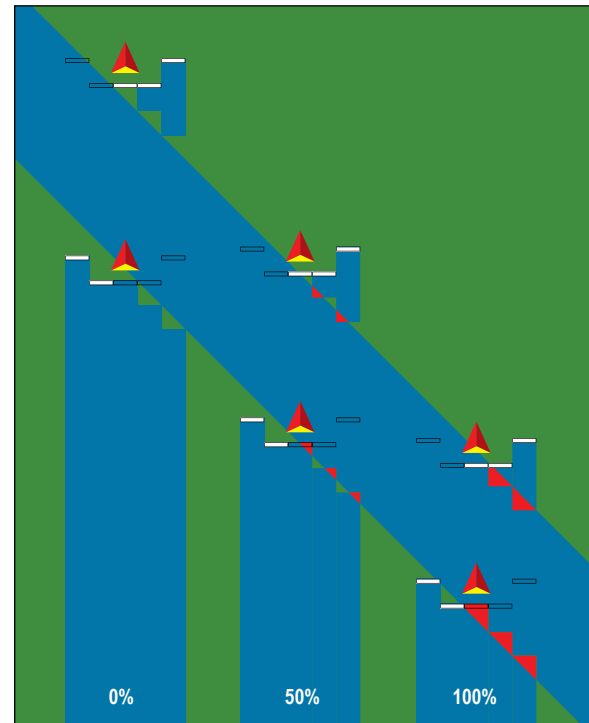

- Application Type – enters the type of product to be applied - options are liquid or granular
- Target Application Rate Preset – presets application rate for up to three (3) Target Application Rates - range is 0.00 to 100000
- Tip Constant – sets an application rate according to the current TeeJet tip – range 0.00 to 100.00
- Ground Speed Override (GSO) – sets the minimum speed used for automatic application rate control - when the vehicle speed falls below this setting, GSO speed is used to control the application rate, rather than the actual ground speed - range is 0.00 to 223.69 mph / 0.00 to 360.00 km/h

Input Output Module (IOM) Pressure Sensor

- Maximum Pressure Rating – used to establish the maximum pressure rating of the pressure sensor as recommended by the manufacturer - range is 1.45 to 435.11 psi / 0.00 to 30.00 bar
- Low Pressure Alarm – used to enter the user determined low pressure point at which the alarm will sound - range is 0.00 to 1450.38 psi / 0.00 to 100.00 bar

- High Pressure Alarm – used to enter the user determined high pressure point at which the alarm will sound - range is 0.00 to 1450.38 psi / 0.00 to 100.00 bar

Figure 57: Staggered Implement Type

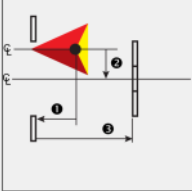

Description: Staggered
 Implement Type: Staggered
 Number of Implement Sections: 5
 Total Width (ft): 50.00

[Change Image](#)

Basic Properties

Description:

GNSS Antenna Height: ft

Guidance Width: ft

Implement Type:

Lateral Implement Offset Direction:

Lateral Implement Offset Distance: ft

In-line Section 1 Offset Direction:

In-line Section 1 Offset Distance: ft

Number of Implement Sections:

Tank/Bin Capacity: gal

Automatic Section Control Aeros/DCM Rate Contr

Unit Overrides

Volume:

Implement Dynamics

Delay On Time: sec

Delay Off Time: sec

Symmetric Implement Layout

	Section Width (ft)	Section Offsets (ft)
1	<input type="text" value="10.00"/>	<input type="text" value="0.00"/>
2	<input type="text" value="10.00"/>	<input type="text" value="20.00"/>
3	<input type="text" value="10.00"/>	<input type="text" value="20.00"/>
4	<input type="text" value="10.00"/>	<input type="text" value="20.00"/>
5	<input type="text" value="10.00"/>	<input type="text" value="0.00"/>

Job Specific Defaults

Overlap:

Application Type:

Target App. Rate Preset #1: gal/ac

Target App. Rate Preset #2: gal/ac

Target App. Rate Preset #3: gal/ac

Tip Constant:

Ground Speed Override: mph

Input Output Module (IOM) Pressure Sensor

Maximum Pressure Rating: psi

Low Pressure Alarm: psi

High Pressure Alarm: psi

Client Profile

A Client profile stores detailed information about a Client and/or business. The Client name can be seen on the Console when importing a Job associated with it.

- ▶ Profile image and information quick view
- ▶ Name – lists detailed information such as Title, Full Name, Suffix and Display As preference
- ▶ Business – lists business information such as business name, job name and tax ID
- ▶ Address – records address information
- ▶ Contact – records contact information and sets contact preferences - click the Go To  button to send an e-mail or access their website
- ▶ Notes – records specific information not mentioned in the predefined fields
- ▶ Associated Profile(s) – displays associated profiles - double-click the image to open the associated profile

Figure 58: Client Profile Sample on Console

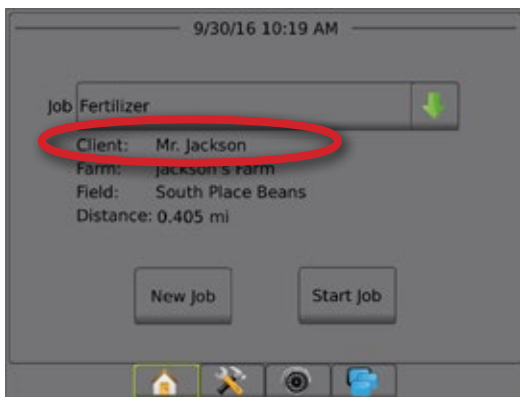



Figure 59: Client Profile Sample in Fieldware Link



[Change Image](#)

Business: Jackson Farms, Inc.
 Care of: Mr. Jackson
 Business Phone: 213-789-1478

Care of

Title

First

Middle

Last

Suffix

Display as

Business

Business Client

Business

Job Name

Tax ID

Address

Street 1

Street 2

City / Town

State / Province / County

Zip Code

Country

Contact

Preference

Home Phone

Cell Phone

Business Phone

Fax

Pager

E-mail 

Website 

Notes

Office hours are 5:00 pm to 9:00 pm - M-F

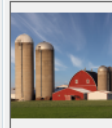

← Associated Profile(s)
 (double click the image to open the associated profile)

Jackson's Farm

Farm Profile

A Farm profile stores specific physical details about a Farm.

- ▶ Profile image and information quick view
- ▶ Description – names the Farm profile
- ▶ Area – records measurements of a piece of ground specified by three (3) options: Mapped, Tillable and Legal (user defined properties – not pulled from Jobs on the console)
- ▶ Notes – records specific information not mentioned in the predefined fields
- ▶ Associated Profile(s) – displays associated profiles - double-click the image to open the associated profile

Figure 60: Farm Profile Sample on Console

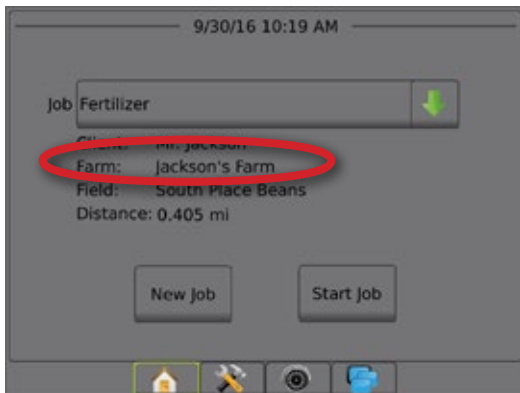
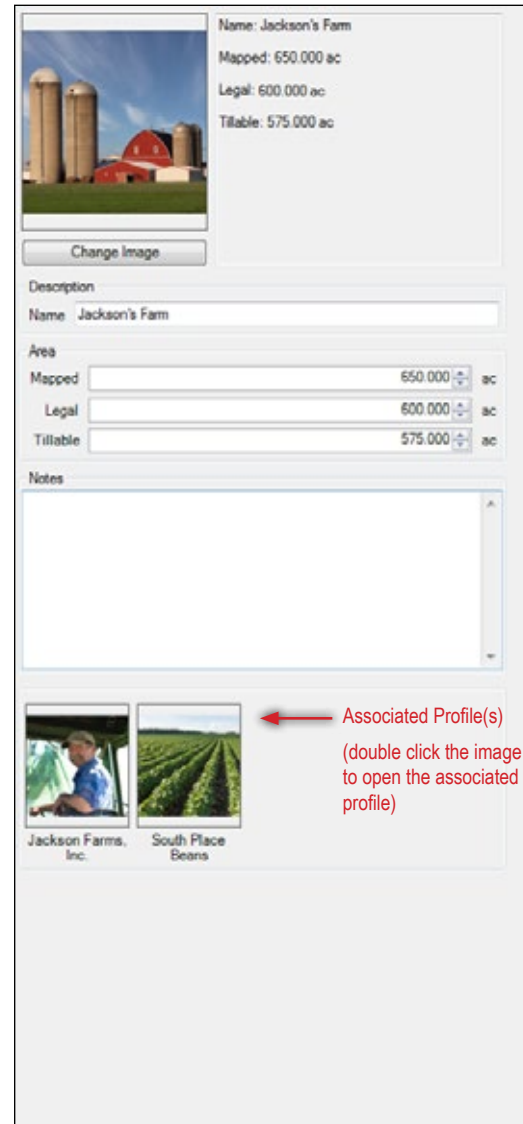

Figure 61: Farm Profile Sample in Fieldware Link



Field Profile

A Field profile stores descriptive and physical information about a field.

NOTE: All values entered in any “Name” fields under Farm Association or Legal sections of a Field profile will be the same throughout the entire Catalog in all Field profiles.

- ▶ Profile image and information quick view
- ▶ Description – name the profile
- ▶ Area – measurement of a piece of ground specified by three (3) options: Mapped, Tillable and Legal (user defined properties – not pulled from Jobs on the console)
- ▶ Farm Association Information – User defined entries.
- ▶ Legal Information – User defined entries.
- ▶ Notes – a place to record specific information not mentioned in the predefined fields
- ▶ Associated Profile(s) – displays associated profiles - double-click the image to open the associated profile

Figure 62: Field Profile Sample on Console

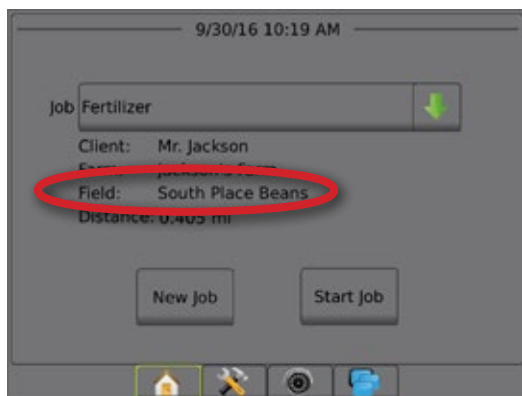

Figure 63: Field Profile Sample in Fieldware Link

The screenshot shows a web-based configuration page for a field profile. At the top left is a photo of a field with a 'Change Image' button below it. To the right of the photo, the profile name is 'South Place Beans' and three area values are listed: 'Mapped: 650.000 ac', 'Legal: 600.000 ac', and 'Tillable: 575.000 ac'. Below this is a 'Description' section with a text input field containing 'South Place Beans'. The 'Area' section contains three input fields for 'Mapped', 'Legal', and 'Tillable', each with a numeric value and a unit of 'ac'. There are 'Update' and 'View' buttons for the boundary. The 'Farm Association' section contains several input fields for 'Name' and 'Value' with labels like 'County', 'FSA Farm #', 'Farm #', 'Tract #', and 'Land Class'. The 'Legal' section contains similar input fields for 'Section #', 'Township #', and 'Range #'. There is also a 'Description' field. At the bottom is a 'Notes' section with a scrollable text area. Below the notes are two small images: 'Jackson's Farm' and 'Fertilizer'. A red arrow points to these images with the text: 'Associated Profile(s) (double click the image to open the associated profile)'.

IMPORTING/EXPORTING

Profiles for Jobs and Machine Settings can be imported or exported to a USB drive for use with the Matrix Pro, Matrix Pro GS or Aeros consoles. See the appropriate user manual specific to the console software version for details on importing and exporting (called transfer) on the console.

To open the Port Profiles tab:

1. Click Port Profiles  toolbar option or View -> Port Profiles menu option.
2. Select the console model from the drop-down menu:
 - ▶ Matrix Pro 570/840 v2.xx – Includes both Matrix Pro and Matrix Pro GS consoles running software version 2.xx. Machine Settings are unsupported and will not be included in a port.
 - ▶ Matrix Pro 570/840 v3.xx – Includes consoles running software version 3.xx and newer. All settings are supported.
 - ▶ Aeros or Matrix Pro 570/840 v4.xx – Includes consoles running software version 4.xx and newer. All settings are supported.
3. Select the USB drive.
4. Click **OK**.

Figure 64: Import/Export

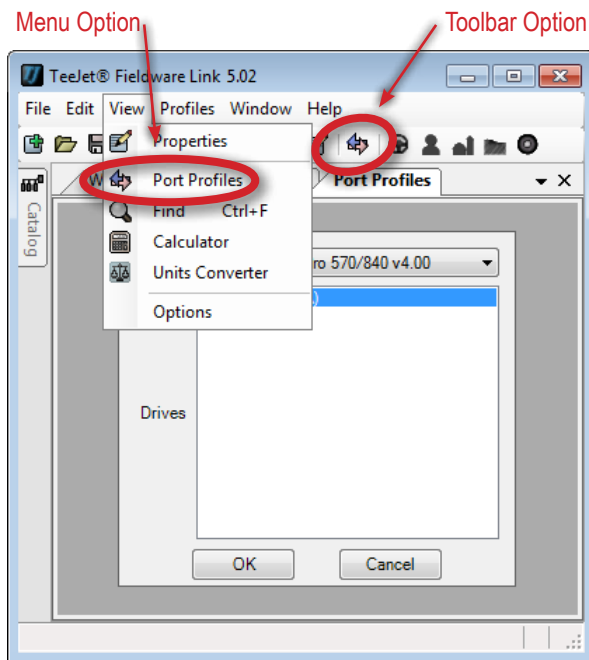
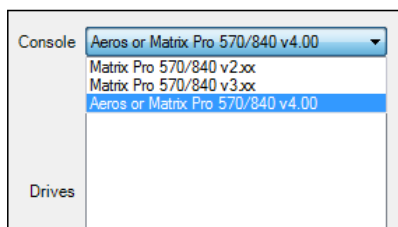

Figure 65: Port Drop-down Menu Options



Exporting Profiles to a Console

NOTE: Exporting a Job profile or a Client/Farm/Field profile containing a Job profile to a USB drive will remove the Job from the Catalog.

To export a profile to the Matrix Pro, Matrix Pro GS, or Aeros:



1. Access the Port Profiles  button.
2. On the catalog, highlight the profile to be exported.
 - ◀ Machine Settings, copy a specific profile
 - ◀ Job, move a specific Job
 - ◀ Field, move all Jobs associated with the selected Field.
 - ◀ Farm, move all Jobs associated with the selected Farm.
 - ◀ Client, move all Jobs associated with the selected Client.
3. Click Export Profile button  or click and drag the profile to the import/export tab.
4. Repeat steps 1 to 2 as needed for other profiles.
5. Click **Done**.
6. Remove USB drive.
7. Insert USB drive into Matrix Pro, Matrix Pro GS or Aeros console.
8. Follow instructions for the specific console software version.

Figure 66: Exporting Profiles to the Console



Jobs with Associated Machine Settings

If a Job profile has Machine Settings associated, a copy of the Machine Settings will also be exported. Along with transferring the Job profile to the Matrix Pro GS, or Aeros v4.xx and newer console, the Machine Settings profile may be transferred into the Matrix Pro GS, or Aeros.

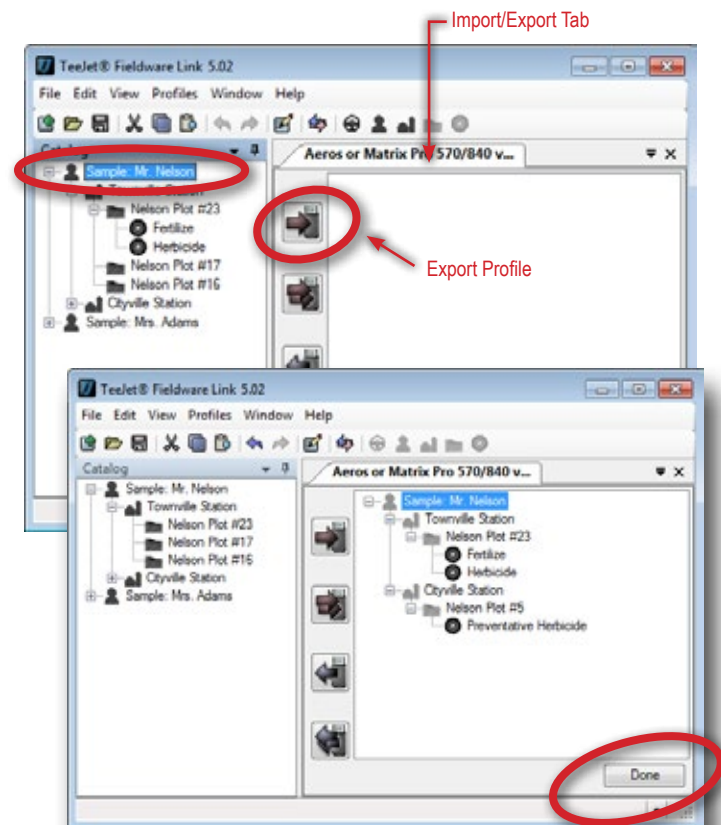
NOTE: When exporting and importing, stored information may not be visible on console. This information is not deleted, instead it is kept in the background until imported back into Fieldware Link.

Figure 67: Job Application Settings

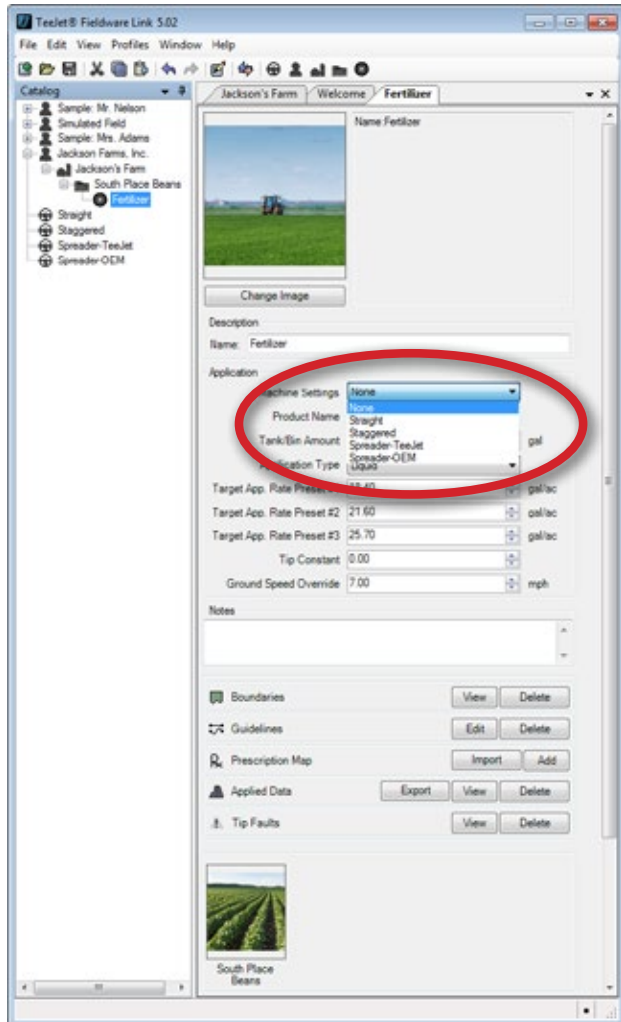
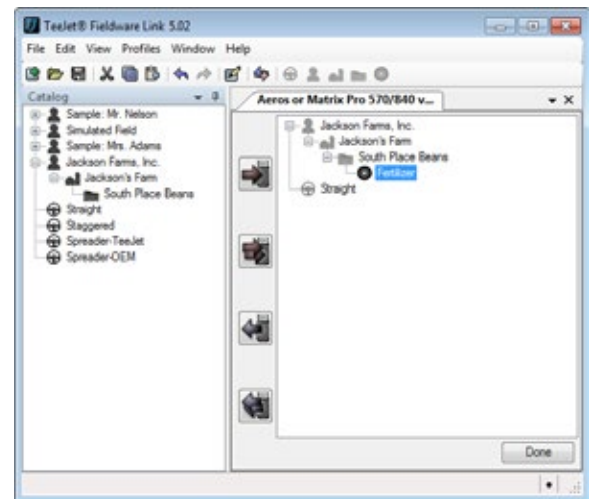

Figure 68: Exporting Job with Associated Machine Settings





Importing Profiles from the Console

If a Job (or Jobs) being imported has not been created or edited in Fieldware Link, it will be placed in a new Client (named "Unknown") within the catalog. The imported Job(s) can be manually moved to a different Client, Farm or Field; or the new Client, Farm and Field can be edited and saved.

Changing the description of a Job or Machine Settings profile does not change how it is recognized by the Matrix Pro, Matrix Pro GS or Aeros console. If you change the name and port the profile to the Matrix Pro, Matrix Pro GS, or Aeros console, it will override the previous profile with the renamed profile.



NOTE: Porting a profile from a USB drive to the catalog will remove it from the USB drive.

To import a profile back into the catalog:

1. Follow instructions for the specific console software version to transfer the profiles to a USB drive.
2. Access the Port Profiles  button.
3. From the USB drive window, highlight the profiles to be merged.
 - ◀The Machine Settings profile, to move a specific profile.
 - ◀The Job, to move a specific Job.
 - ◀The Field, to move all Jobs associated with the selected Field.
 - ◀The Farm, to move all Jobs associated with the selected Farm.
 - ◀The Client, to move all Jobs associated with the selected Client.
4. Either click the MERGE SELECTED button , right-click and choose MERGE  or click and drag to the catalog*.
5. Repeat steps 1 to 2 as needed for other profiles (only one can be selected at a time).
6. Click **DONE**.
7. Remove USB drive.

NOTE: *Clicking and dragging into the catalog will place the Job where dropped – not where it was associated on the USB drive.

To merge all Jobs back into the catalog:

1. Follow instructions for the specific console software version to transfer the profiles to a USB drive.
2. Access the Port Profiles  tab.
3. Click Merge All Into Catalog  button.
4. Click **Done**.
5. Remove the USB drive.

NOTE: If the user fails to click the **Done** button to complete a transfer, a warning window will pop up to inform the user of possible damaged to data.

Figure 69: Warning Message

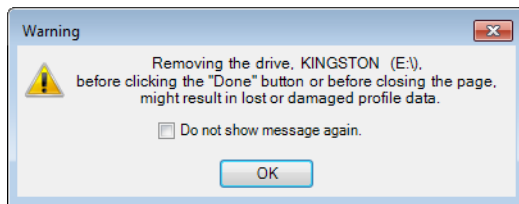

Figure 70: Importing Job Data from the Console

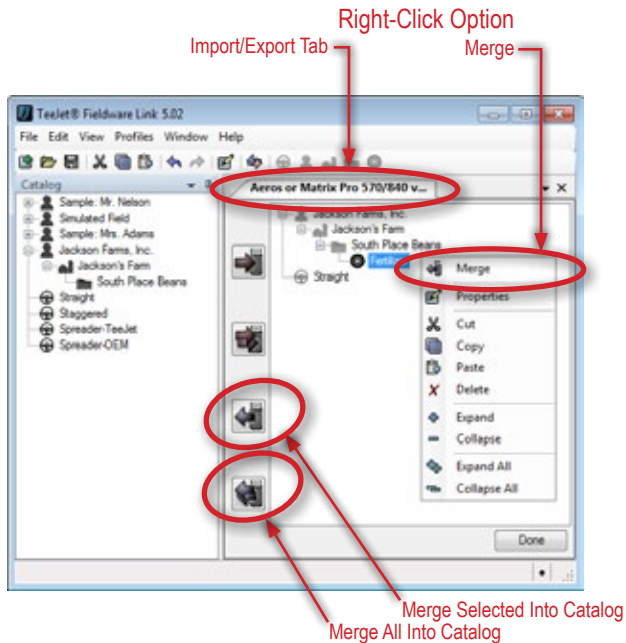
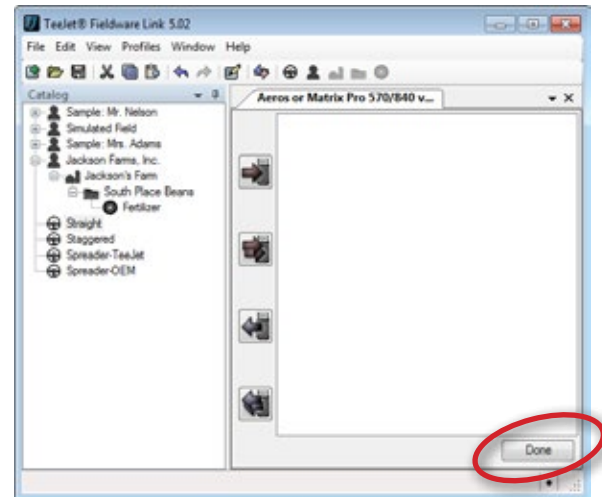

Figure 71: Completing a Transfer by clicking the Done button.



APPLICATION MAPPING

ACCESSING MAPS

To access a map:

1. View a Job Profile with mapping data from the catalog.
2. Select from the following:
 - ▶ Boundaries – select **View** to view the boundary(s) on a map and use the Measure Distances tool
 - ▶ Guidelines – select **Add** to open the existing boundary or map in the location of the deleted boundary to add new guideline information or **Edit** to edit an existing guideline(s) on a map or add a straight AB or curved AB guideline(s)
 - ▶ Prescription Maps – select **Add** to open the existing boundary to add prescription information to the existing boundary or **Edit** to edit the existing prescription map
 - ▶ Applied Data – select **View** to view the applied data on a map
 - ▶ Tip Faults – select **View** to view the tip faults on a map
3. Click the SAVE button  if edits have been made to a guideline or prescription map.

Figure 72: Example of Options on a Job Profile



OVERVIEW

Boundaries, guidelines, applied data, and prescription mapping can be copied from one job to another, eliminating the need to re-record field boundaries and information. The ability to reuse guidelines means work patterns and directions can be duplicated exactly for subsequent jobs.

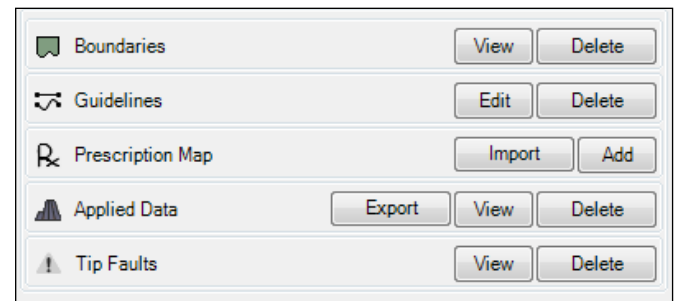
There are five maps available:

- ▶ Boundaries – application boundaries establish areas where product is and is not applied while using ASC or BoomPilot. On the Matrix Pro G, Matrix Pro GS or Aeros console, boundaries can be established in all guidance modes. One exterior boundary and up to five (5) interior boundaries can be stored at one time. A boundary cannot be drawn; it must be established on a console or provided in a third-party prescription map.
- ▶ Guidelines – AB guidelines, Azimuth guidelines, next pass guidelines, and NextRow guidelines are each available depending on the current guidance mode on the Matrix Pro G, Matrix Pro GS or Aeros console. Up to 25 established guidelines can be stored in the console per job.
- ▶ Prescription Maps – map files consisting of geospatially defined application rate zones which provide information to the rate controller for use in applying product.
- ▶ Applied Data – applied data is a record of areas covered by the implement and how much and where product has been applied
- ▶ Tip Faults – when a Tip Flow Monitor Kit is present on an Aeros system, a Tip Flow Monitor is available. After the tips are balanced, the system will monitor all the tips and their the flow rate if their respective boom section is turned on. The flow rate of each tip must be within the percentage range. If any tip is outside this range, an error will be generated, and the user will need to inspect the tip that is at fault. These faults are recorded and available to be viewed on a map.

Map Screen Overview

The mapping utility allows viewing and editing of many map details. Each map offers a different set of options specific to that map type.

- Map image
 - Zoom In/Zoom Out – use the mouse wheel
 - Move Map – right-click and drag
- Map Editing Tools
 - Guidelines – adds new straight AB or curved AB guidelines; edit existing guidelines; measure distance on the map
 - Prescription Maps – cut existing boundary or region into new regions; fill region; measure distance on the map
- Location – displays the Longitude/Latitude coordinates of the cursor on the map
- Bottom Tabs
 - Guidelines – lists each guideline; when scrolled over, guideline is highlighted on the map; when selected, guideline details are displayed
 - Prescription Maps – lists each prescription area; when scrolled over, area is highlighted on the map; when selected, map and region details are displayed
 - Applied Maps – lists each applied area; when scrolled over, applied area(s) is highlighted on the map; when selected, map and region details are displayed
 - Tip Faults – lists each tip fault; when scrolled over, tip fault is highlighted on the map; when selected, fault details are displayed
- Map and Region Details
 - Guidelines – allows editing of the name or to delete the selected guideline
 - Prescription Maps – displays map details; allows editing to region details and minimum/maximum rate colors
 - Applied Maps – displays map details; allows editing to region details and minimum/maximum rate colors
 - Tip Faults – displays fault name
- Save Map Profile – when unsaved changes have been detected, click the Save  button.

Figure 73: Prescription Maps Example Overview



Menu Bar

Boundary Map

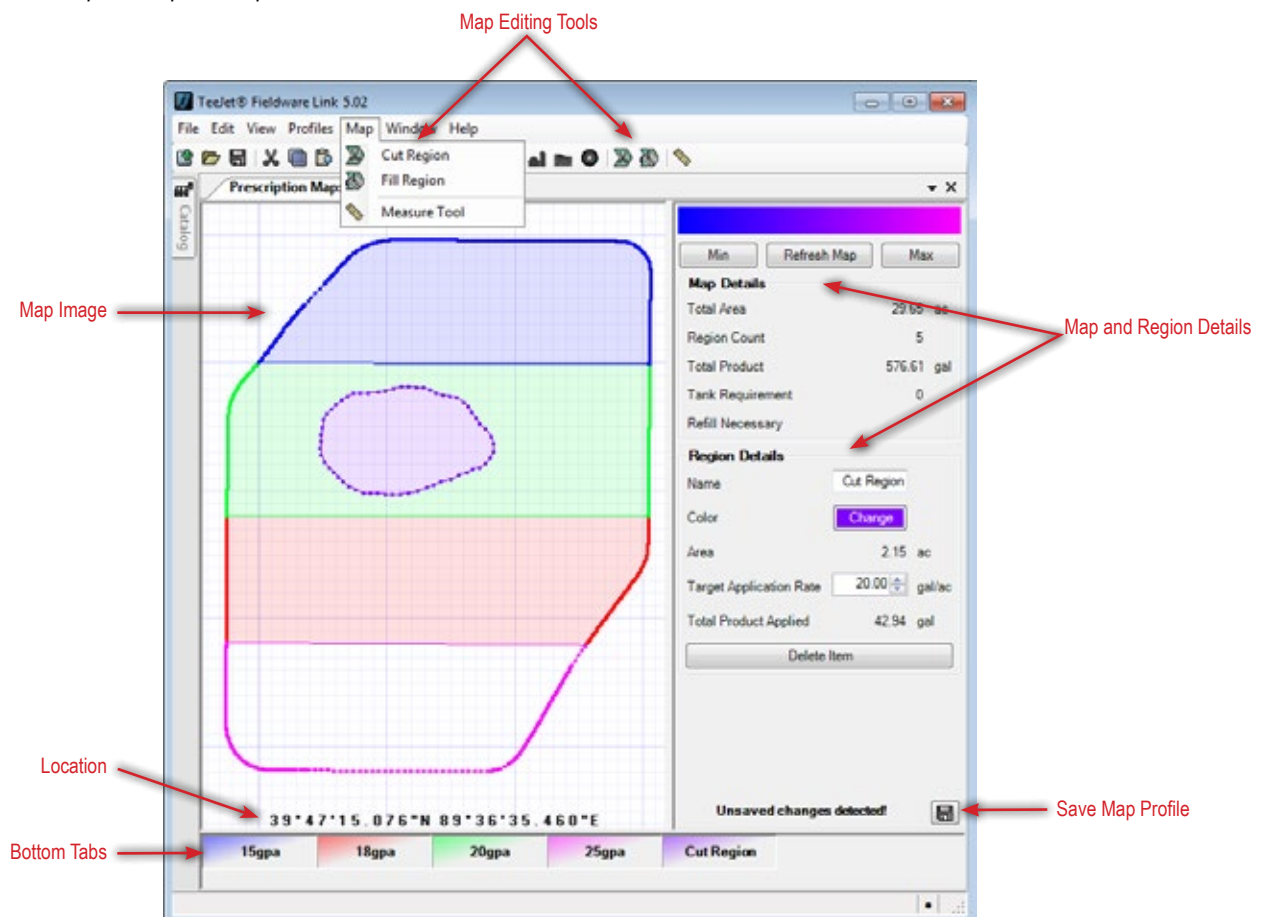
The Boundary Map menu provides basic tools for editing maps.

Figure 74: Boundary Map Menu

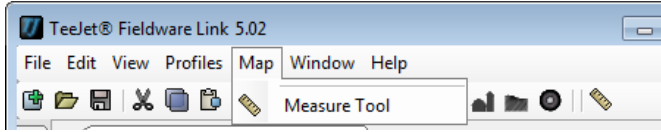



Table 10: Boundary Map Menu Options

Icon	Description
	Measure Distances – measures distances on the map

Guidelines Map

The Guidelines Map menu provides basic tools for editing maps.

Figure 75: Guidelines Map Menu

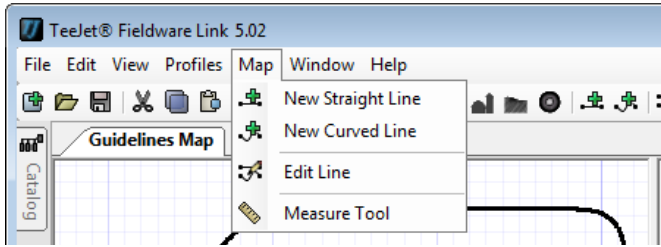





Table 11: Guidelines Map Menu Options

Icon	Description
	Create New Straight Line – draws two points connected by a straight line
	Create New Curved Line – draws curved line that can have multiple points connecting on a curve or with straight lines
	Edit Line – changes the location of points on a guideline
	Measure Distances – measures distances on the map

Prescription Map

The Prescription Map menu provides basic tools for creating and editing maps.

Figure 76: Prescription Map Menu

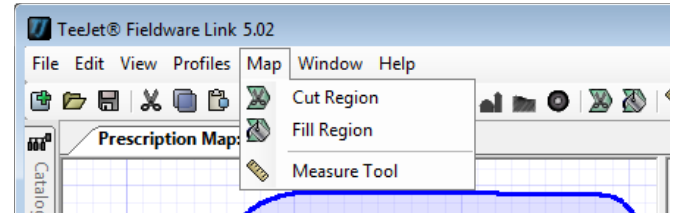





Table 12: Prescription Map Menu Options

Icon	Description
	Cut Region – draws a region to be removed from
	Fill Region – XXXX
	Measure Distances – measures distances on the map

Applied Data Map

The Applied Data Map menu provides basic tools for editing maps.

Figure 77: Applied Data Map Menu

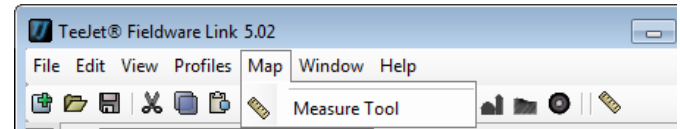



Table 13: Applied Data Map Menu Options

Icon	Description
	Measure Distances – measures distances on the map

Tip Faults Map

The Tip Faults Map menu provides basic tools for editing maps.

Figure 78: Tip Faults Map Menu

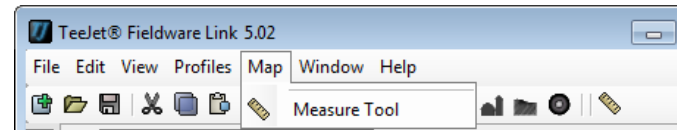



Table 14: Tip Faults Map Menu Options

Icon	Description
	Measure Distances – measures distances on the map

BOUNDARY MAP

Application boundaries establish areas where product is and is not applied while using ASC or BoomPilot. On the Matrix Pro G, Matrix Pro GS or Aeros console, boundaries can be established in all guidance modes. One exterior boundary and up to five (5) interior boundaries can be stored at one time. A boundary cannot be drawn; it must be established on a console or provided in a supported format prescription map.

- ▶ View – select to view the boundary(s) on a map and use the Measure Distances tool
- ▶ Delete – select to delete all boundaries in the current job profile

View

Select to view the boundary(s) on a map.

Figure 79: View

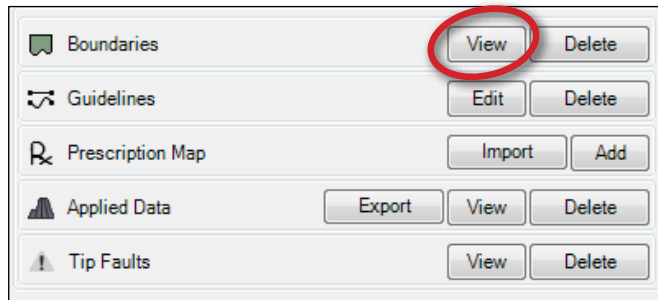
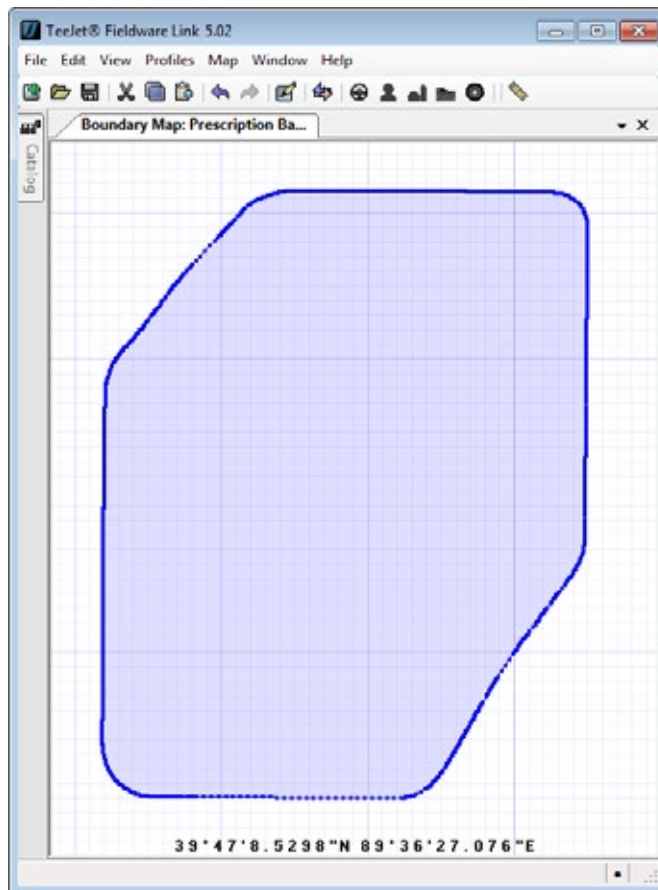

Figure 80: Boundary Map



Measure Distances Tool

Select to measure distances on the boundary map.

Figure 81: Measure Distances Tool

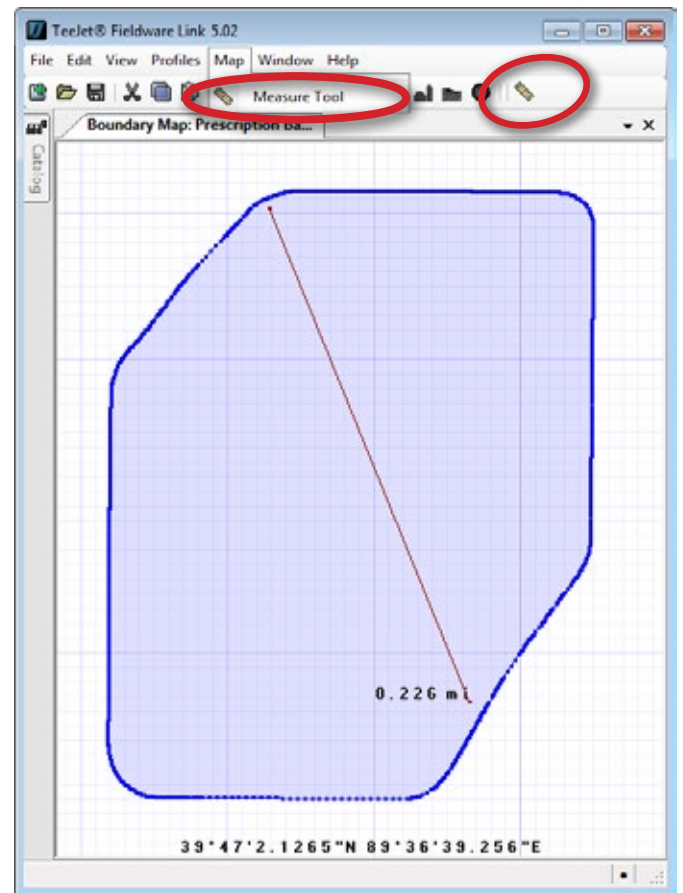

Delete

Select to delete all boundaries in the current job profile

Figure 82: Delete

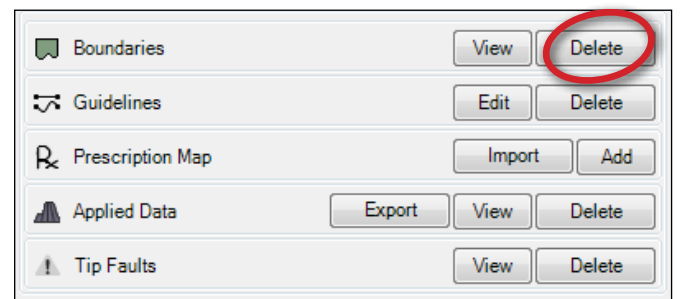

GUIDELINES MAP

AB guidelines, Azimuth guidelines, next pass guidelines, and NextRow guidelines are each available depending on the current guidance mode on the Matrix Pro G, Matrix Pro GS or Aeros console. Up to 25 established guidelines can be stored in the console per job.

- ▶ Add – select to open the existing boundary or map in the location of the deleted boundary to add new guideline information
- ▶ Edit – select to edit an existing guideline(s) on a map or add a straight AB or curved AB guideline(s)
- ▶ Delete – select to delete all guidelines in the current job profile

Add or Edit

Select **Add** to open the existing boundary or map in the location of the deleted boundary to add new guideline information.

Select **Edit** to edit an existing guideline(s) on a map or add a straight AB or curved AB guideline(s).

Figure 83: Add

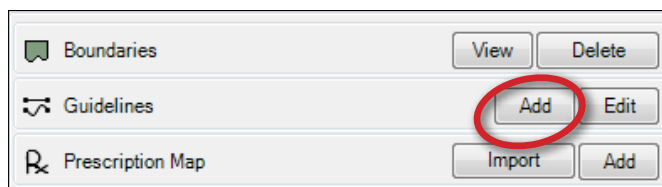
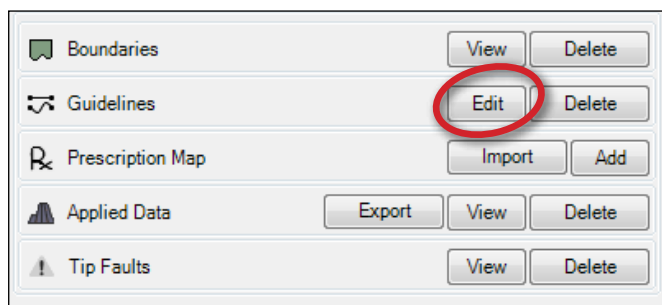

Figure 84: Edit



New Straight AB Guideline

A straight line will have two point connected by a straight line.



1. Select Map->New Straight Line or CREATE NEW STRAIGHT LINE button .
2. Click Point A on the map.
3. Click Point B on the map.
4. Press Enter key on the keyboard.
5. Rename the guideline, if desired.
6. Select SAVE CHANGES button .

Figure 85: Straight AB Guideline Tool



New Curved AB Guideline

A curved line can have multiple points that can connect on a curve or with straight lines. Curved guidance is recommended not to exceed 30° within the AB guideline. While working in a bounded area, the guidance pattern extending beyond the established A Point Bs will be straight-line guidance.

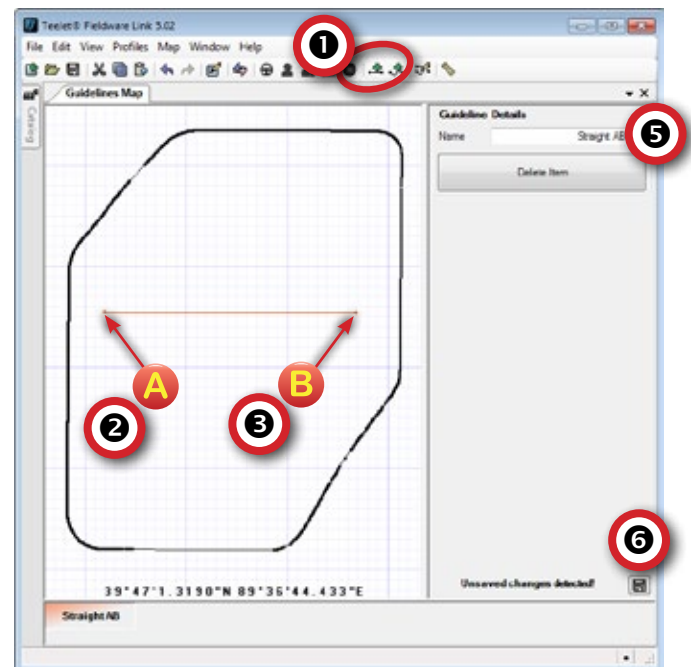

1. Select Map->New Curved Line or CREATE NEW CURVED LINE button .
2. Click Point A on the map.
 - To create a straight line between two points, click and release the point.
 - To create a curved line between two points, click and hold the cursor while drawing the curved line.
3. To set the Point B, press Enter key on the keyboard.
4. Rename the guideline, if desired.
5. Select SAVE CHANGES button .

Figure 86: Curved AB Guideline Tool



Edit Guideline

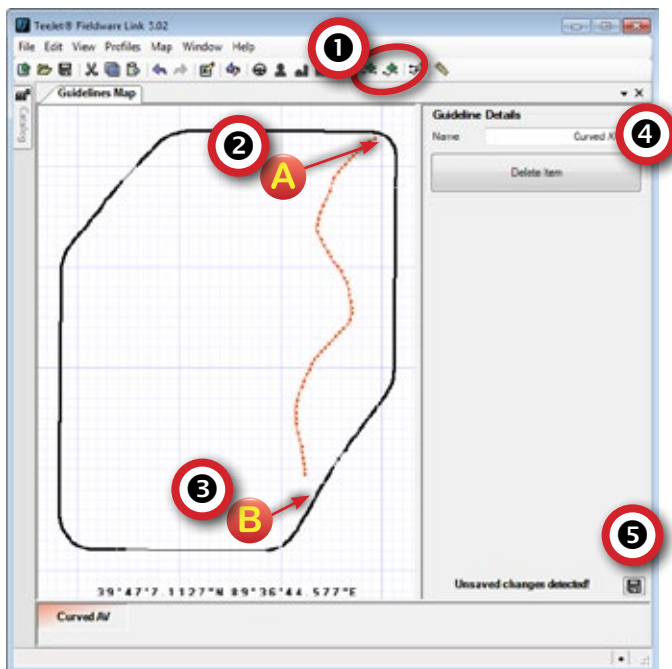

1. Select Map->Edit Line or EDIT LINE button .
2. Select point on existing line.
 - Straight AB Line – click and drag Point A or Point B to the new location on the map.
 - Curved AB Line – click and drag any point on the line to the new location on the map.
3. Select SAVE CHANGES button .

Figure 87: Edit Guideline Tool



Measure Distances Tool

Select to measure distances on the guideline map.

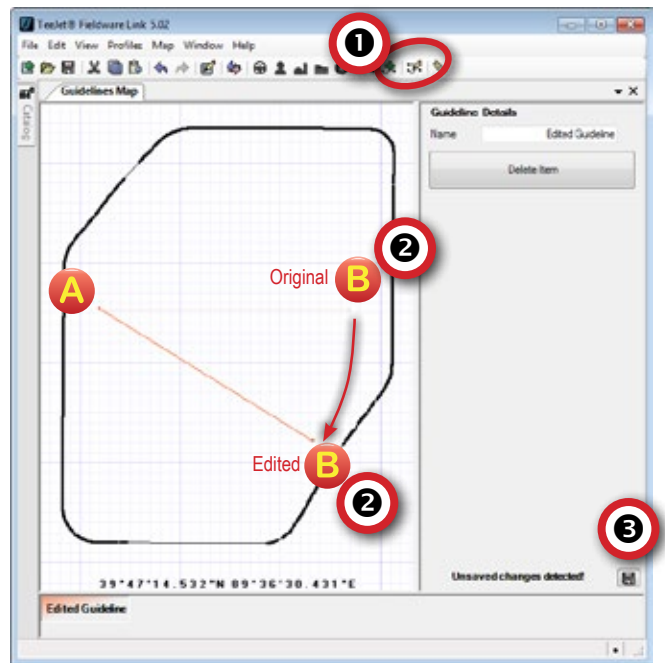
Figure 88: Measure Distances Tool

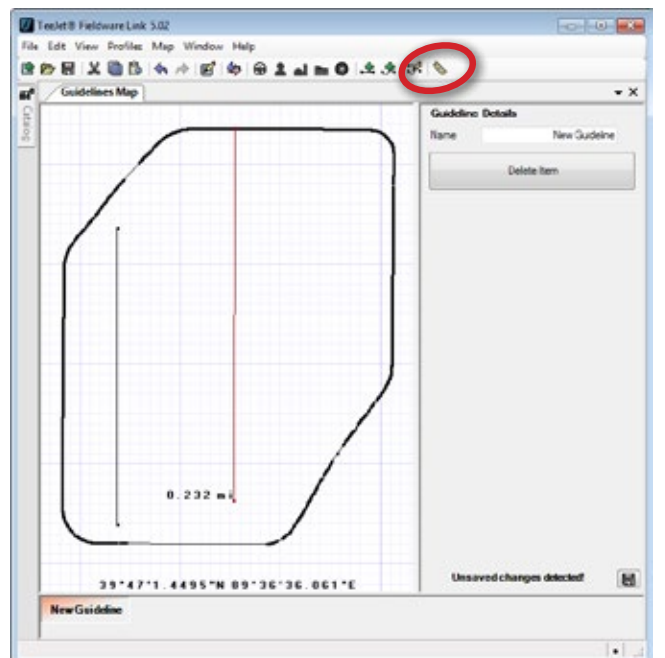

Guideline Details

The guideline details section gives the options to rename or delete selected guidelines. Click on a guideline from the Bottom Tabs to rename or delete.

To rename a guideline:

1. Click on a guideline from the Bottom Tabs.
2. Click in the Name box to edit the name.
3. Select SAVE CHANGES button .

To delete a guideline:

1. Click on a guideline from the Bottom Tabs.
2. Click **Delete Item**.
3. Select SAVE CHANGES button .

Figure 89: Guideline Details



Delete

Select to delete all guidelines in the current job profile.

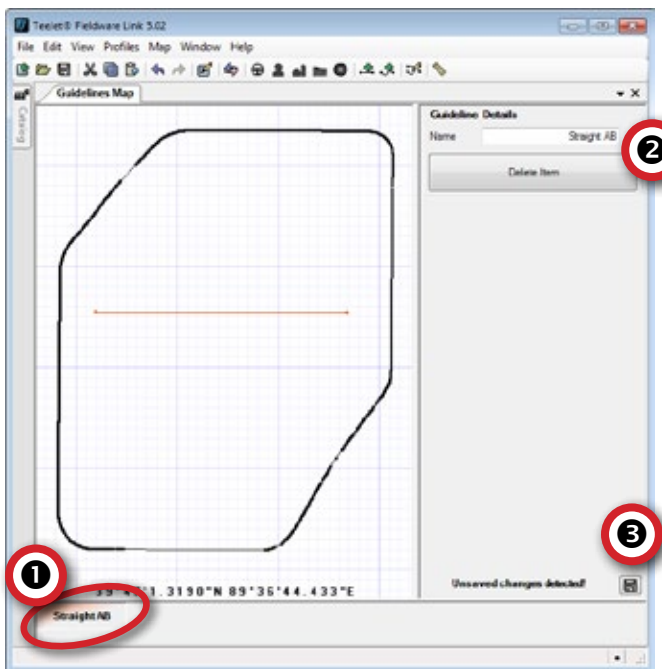
Figure 90: Delete

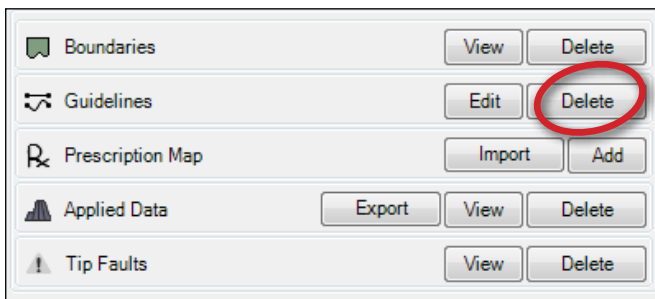

PRESCRIPTION MAPS

Prescription Map Files consist of geospatially defined application rate zones which provide information to the rate controller for use in applying product. To add a prescription map to a Job the user may import the map from a supported format or manually create the map using the drawing tools of Fieldware Link.



NOTE: USE FIELDWARE CONVERT

If a prescription map does not need to be edited, only to be converted to a TeeJet format to be used in a TeeJet job, use Fieldware Convert instead of Fieldware Link.

Fieldware Convert can be downloaded at www.teejet.com/support/software.

Prescription map data is loaded into the console when properly placed into a valid TeeJet Job.

Only single channel/single product prescriptions are supported. Multi-product VRA is not supported.

Prescription application only works for Aeros and Matrix Pro GS consoles connected to a controller supporting VRA.

- ▶ Import – select to load an existing prescription map from a supported format
- ▶ Add – select to manually create a prescription map based on an existing boundary in the Job
- ▶ Edit – select to edit a prescription map already existing within a Job
- ▶ Delete – select to delete the existing prescription map

Figure 91: Prescription Map Options

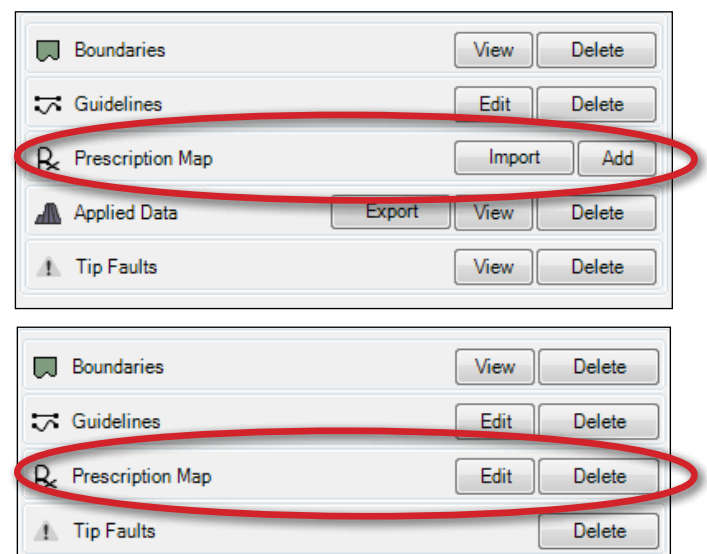

Import

Using Fieldware Link is one of two methods allowed to import a prescription map into a job. If a prescription map does not need to be edited, only to be converted to a TeeJet format to be used in a TeeJet job, use Fieldware Convert instead of Fieldware Link.

To import a prescription exported from an Ag GIS/FMIS requires the following:

- The user has properly created a Job into which the prescription map file can be imported
- The format is supported by Fieldware Link
 - TeeJet Application Rate Management (*.arm)
 - ESRI™ Shapefile (*.shp)
 - ISOXML (taskdata.xml)
- The prescription file contains only a VRA application for a single channel/product only

For more details on each of these file types, see “Appendix B – Supported FMIS Data Details”.

ISOXML/ARM

When converting an ISO-11783 ISOXML or Mid-Tech/TeeJet ARM file, use the following procedure:

1. Open a new or existing Job that does not already have a prescription map associated with it.
2. Click Prescription Map **Import**.
3. Select the Map File Type.
 - ▶ TeeJet Application Rate Management
 - ▶ ISOXML
4. Highlight the map file; click **Open**.
5. Manually edit the map as needed.

Figure 92: Import

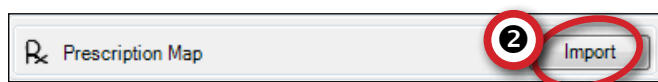
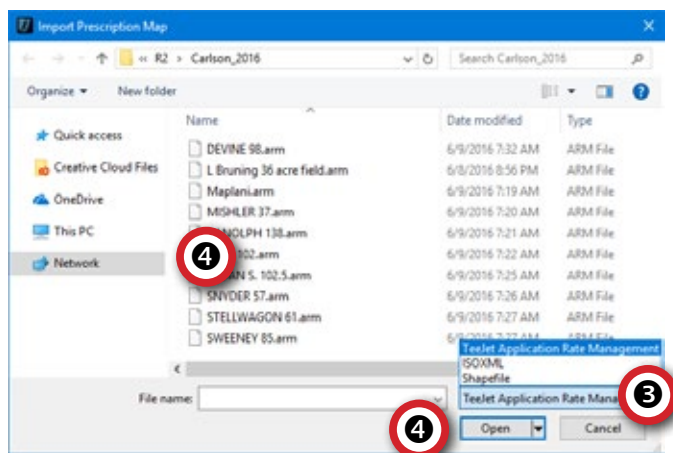

Figure 93: Import Prescription Map



SHP

When converting an ISO-11783 ISOXML or Mid-Tech/TeeJet ARM file, use the following procedure:

1. Open a new or existing Job that does not already have a prescription map associated with it.
2. Click Prescription Map **Import**.
3. Select the Map File Type **Shapefile**.
4. Highlight one or more map files (use the Shift and Control keys + mouse clicks to select one or more files); click **Open**.
5. Adjust Shape Database Field attributes accordingly. See Shape Database Fields Variation 1, Variation 2 or Variation 3 as examples; click **Submit**.
6. Manually edit the map as needed.

Figure 94: Import

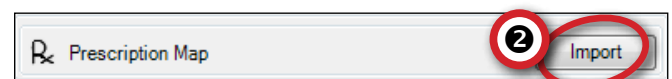
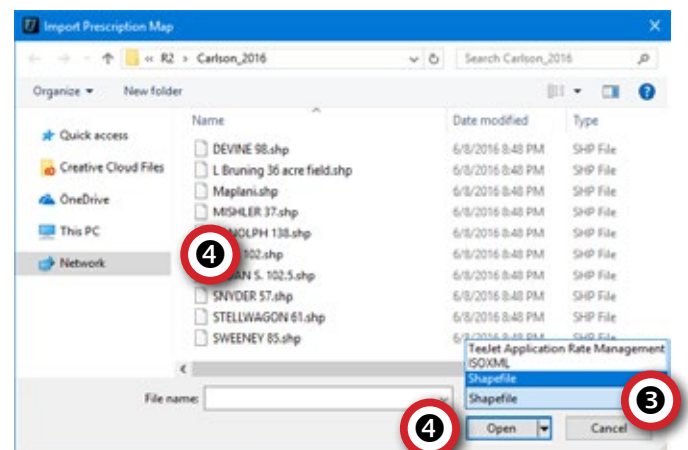

Figure 95: Import Prescription Map



Shape Database Fields

A user MUST identify three things when converting a SHP file; the product's Name, the product's application Units (e.g. pounds/acre), and the product's application rate values.

Variation 1

DBF field names match those pre-defined by the TeeJet Shape Import instructions; "Prod_Name", "Prod_Unit", "Prod_Rate"

This results in an "autofill" of the Product information fields.

Figure 96: Field Names Match Pre-defined Information

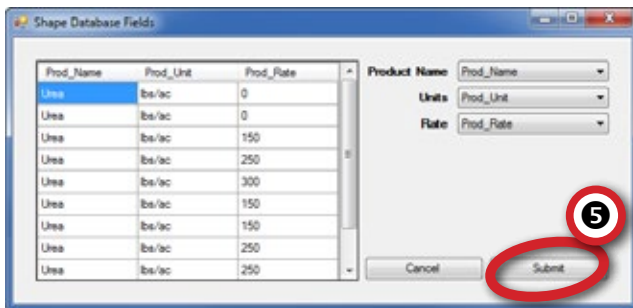

Variation 2

DBF field names DO NOT match those pre-defined by the TeeJet Shape Import instructions.

1. Select proper field names identifying the Field's "Product Name", "Unit" and "Rate" data.

NOTE: In this case, if all SHP files have the same DBF field names (column names) then when multiple files are selected for conversion, after establishing them once, the same choices are used on subsequent conversions when more than one SHP has been selected for conversion.

Figure 97: Field Names DO NOT Match Pre-defined Information

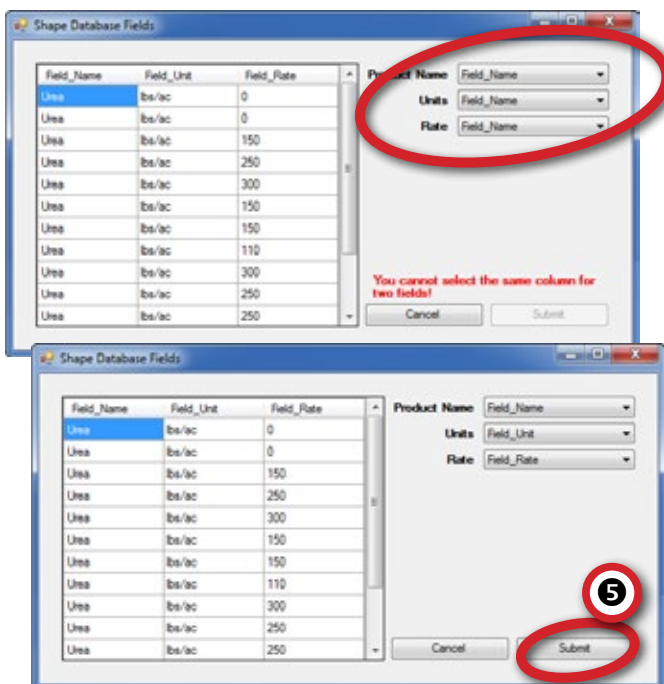

Variation 3

Only a single DBF Field containing the Product Rates is provided.

Identify the Field's "Product Name" and "Unit" data:

1. Select Product Name: **Mix** to change selection to **Custom**.
2. Enter a custom product name in the Custom Name text box.
3. Select Units: **Mix** to change selection to **Custom**.
4. Select an application unit type for the product from the drop-down menu.

The "Rate" drop down dialogue automatically chooses the DBF field named Mix to get the rate values.

NOTE: This variation has extensions if more than one DBF field (column) exists but only one of them contains the required information.

Figure 98: Single Field Containing the Product Rates

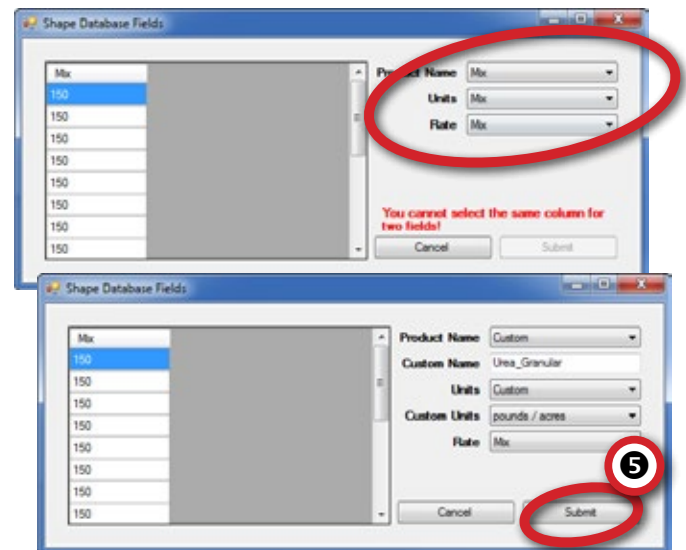

Add or Edit

Add – Manually Creating a Prescription

Fieldware Link allows the user to manually create prescription rate zones based on an existing boundary.

- User must first create a job and add a boundary file to it; without the boundary file, Fieldware Link does not know what coordinates to use when creating the polygon rate zones
- User is restricted to a maximum of 255 different rates in the prescription file
- User can create as many polygons as they desire so long as the number of different rates to apply is 255 or less

NOTE: each polygon must have a rate assigned. Different polygons can have the same rate which allows for more polygons than rates.

Select **Add** to open the existing boundary to add prescription information to the existing boundary.

Figure 99: Add Prescription Information to Existing Boundary

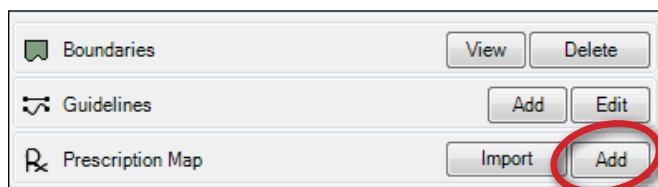

Edit – Editing an Existing Prescription

Fieldware Link allows the user to manually edit existing prescription files and individual rate polygons. This could aid the user if there is a need to change rate values or delete application polygons from the prescription. Or if the application grid imported was not trimmed to the boundary.

Select **Edit** to edit the existing prescription map.

Figure 100: Edit



Cut Region

Cut region allows a boundary or an existing region on the map to be divided or a internal polygon to be created.

To divide a region:

1. Select Map->Cut Region or CUT REGION button .
2. Using the left mouse button, draw a division line across the boundary or region.
3. A blank region tab will appear in the Bottom Tabs.
4. Select the new region tab to rename the region, if desired, using the Region Details options.

5. Select SAVE CHANGES button .

Figure 101: Cut Region Tool – Divide Region

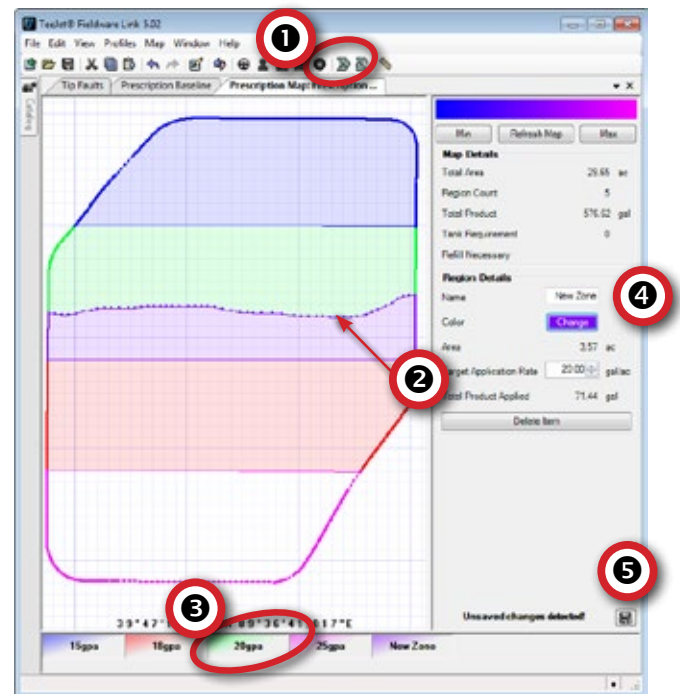

To create an internal polygon:



1. Select Map->Cut Region or CUT REGION button .
2. Using the left mouse button, draw an Internal Polygon out of an existing region.
 - Internal Polygons cannot extend over multiple regions.
 - Internal Polygons will not have any Region Properties until it has been filled. See the Fill Region section for details.
3. Select SAVE CHANGES button .

Figure 102: Cut Region Tool – Internal Polygon



Fill Region

Fill region allows an internal polygon on the map to be changed to a designated region.

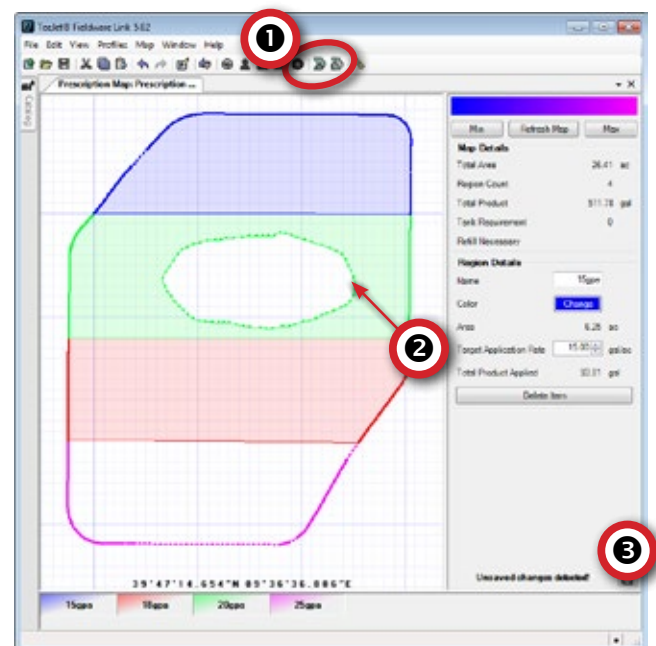

1. Select Map->Fill Region or FILL REGION button .
2. Click on the unfilled internal polygon.
3. A **New Zone** tab will appear in the Bottom Tabs.
4. Select the new region tab to rename the region, if desired, using the Region Details options.
5. Select SAVE CHANGES button .

Figure 103: Fill Region Tool



Measure Distances Tool

Select to measure distances on the prescription map.

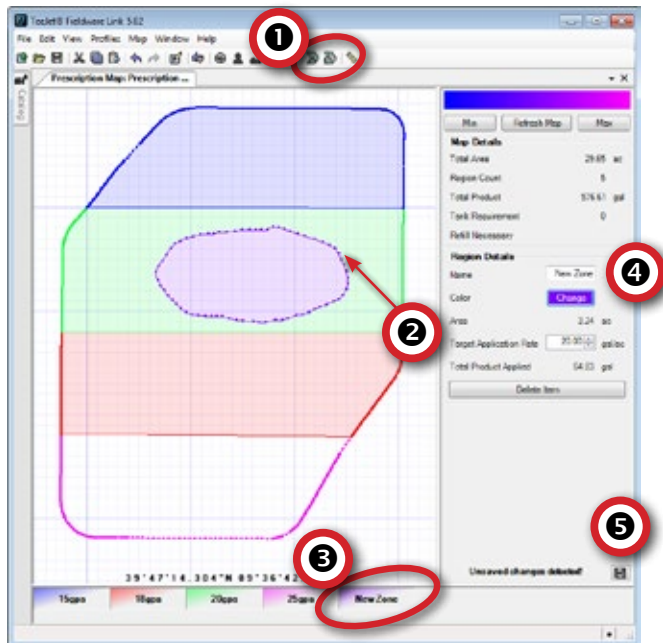
Figure 104: Measure Distances Tool

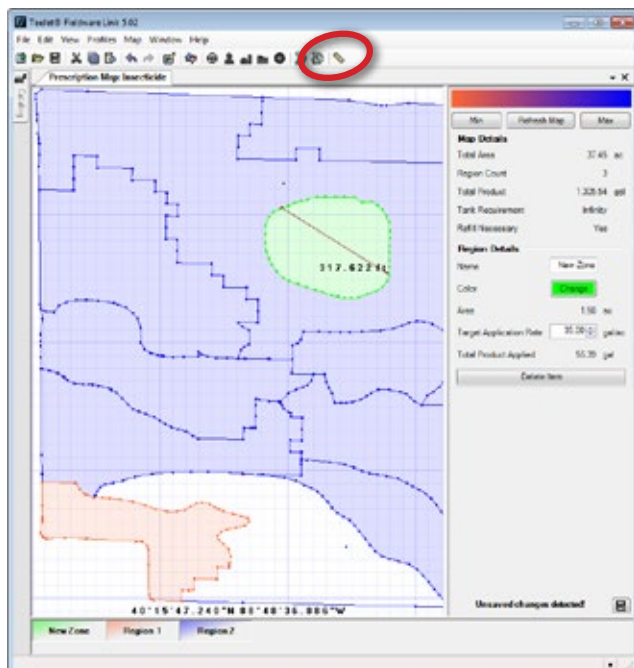

Color Range Selection

Above Map Details, select corresponding display colors for mapping maximum/minimum rate limits. Using the Min/Max selector will override any regional color selections.

1. Select:
 - ▶ Minimum Rate Color – used to set the color for the minimum rate
 - ▶ Maximum Rate Color – used to set the color for the maximum rate
2. Select **Refresh Map**.

Figure 105: Color Range Selection Options

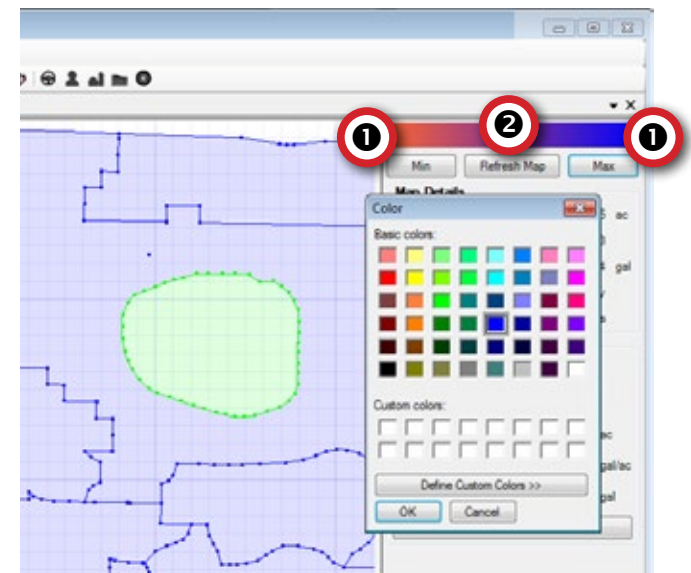

Map Details

The map details section displays applied data details including total area covered, number of application rate regions, total product applied, tank requirements and if tank refills are necessary.

Figure 106: Map Details

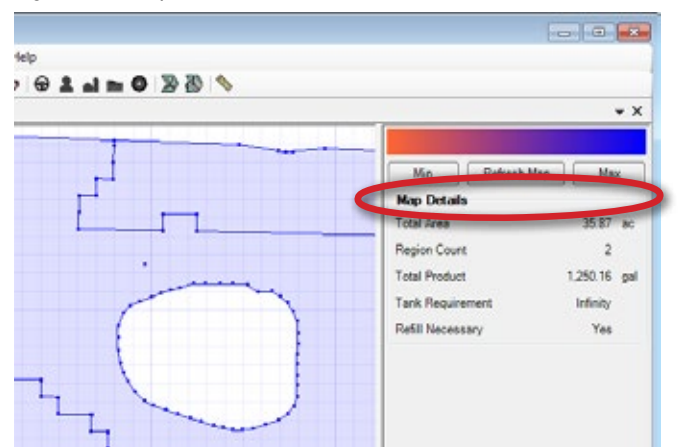

Region Details

The region details section gives the options to rename, override individual region color, adjust the region's application rate, delete a region or internal region, or view information including region area and region's total applied product. Click on a region from the Bottom Tabs to rename, recolor, adjust rates or delete a region or internal region.

To rename a region:

1. Click on a region from the Bottom Tabs.
2. Click in the Name box to edit the name.
3. Select SAVE CHANGES button .

To adjust the region's application rate:

1. Click on a region from the Bottom Tabs.
2. Click the Target Application Rate UP/DOWN buttons to edit the rate.
3. Click **Refresh Map** to update the minimum/maximum colors to reflect the rate change.
4. Select SAVE CHANGES button .

To delete a region:

1. Click on a region from the Bottom Tabs.
2. Click **Delete Item**.
3. Select SAVE CHANGES button .

To delete an internal polygon:

1. Click on the internal polygon's Bottom Tab or a region from the Bottom Tabs that contains the internal polygon.
2. Click **Delete Item** or **Delete (xxx points)** in the Internal Polygons section.
3. Select SAVE CHANGES button .

Figure 107: Region Details



Delete

Select to delete all prescription map data in the current job profile.

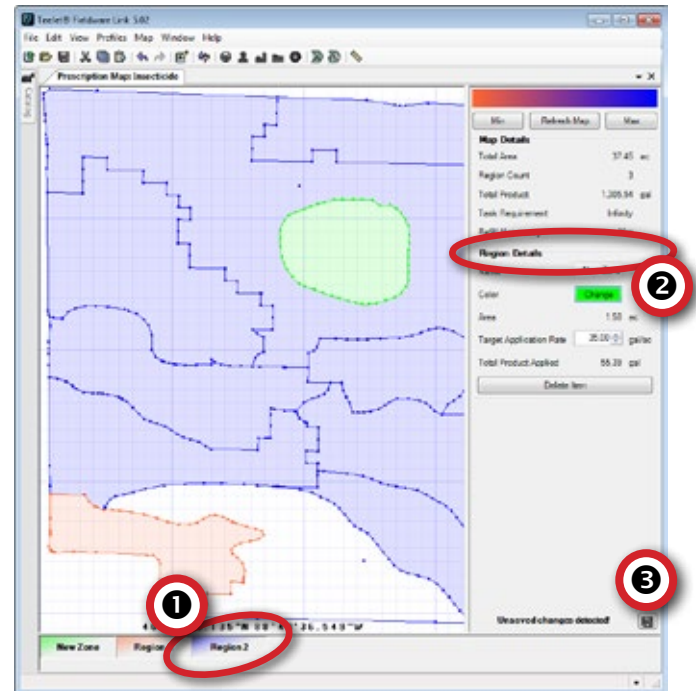
Figure 108: Delete

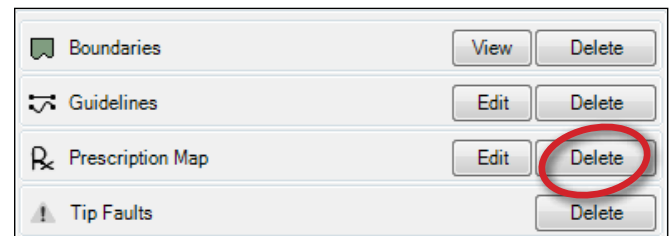

APPLIED DATA MAP

Applied data is a record of areas covered by the implement and how much and where product has been applied.

- ▶ Export – select to export the applied data record to an XML file to be used for other external mapping options
- ▶ View – select to view the applied data on a map and use the Measure Distances tool
- ▶ Delete – select to delete all applied data in the current job profile

Export

Select to export the applied data record to an XML file to be used for other external mapping options.

Figure 109: Export

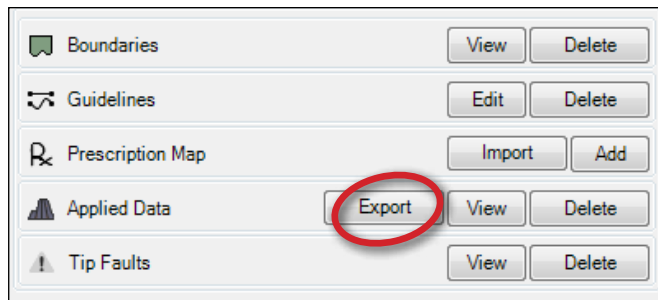

View

Select to view the applied data on a map and use the Measure Distances tool.

Figure 110: View

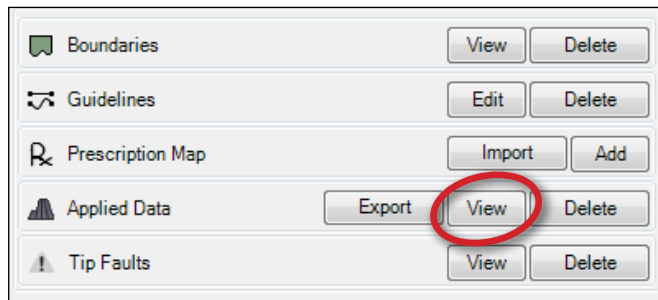
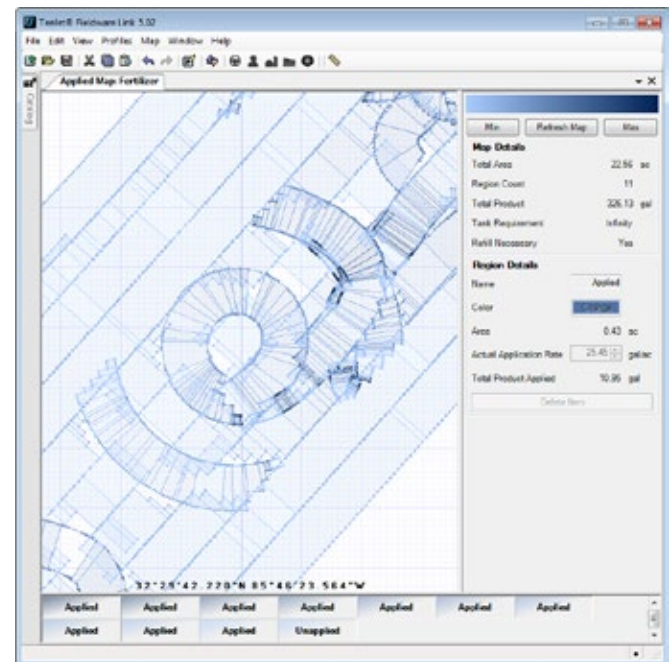

Figure 111: Applied Data Map



Measure Distances Tool

Select to measure distances on the applied data map.

Figure 112: Measure Distances Tool

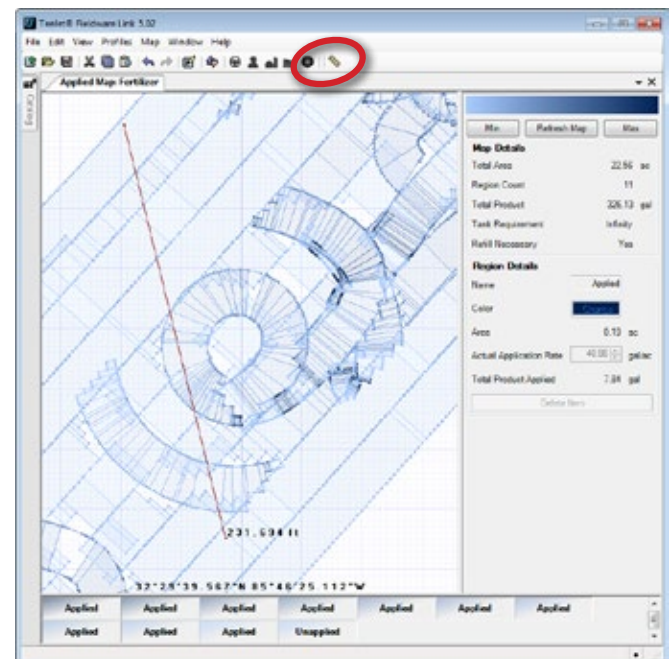

Color Range Selection

Above Map Details, select corresponding display colors for mapping maximum/minimum rate limits. Using the Min/Max selector will override any regional color selections.

1. Select:
 - ▶ Minimum Rate Color – used to set the color for the minimum rate
 - ▶ Maximum Rate Color – used to set the color for the maximum rate
2. Select **Refresh Map**.

Figure 113: Color Range Selection Options

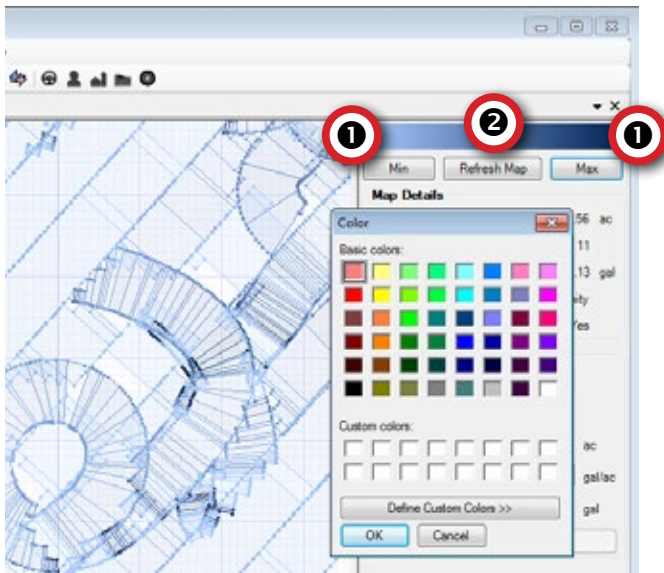

Map Details

The map details section displays applied data details including total area covered, number of application rate regions, total product applied, tank requirements and if tank refills are necessary.

Figure 114: Map Details

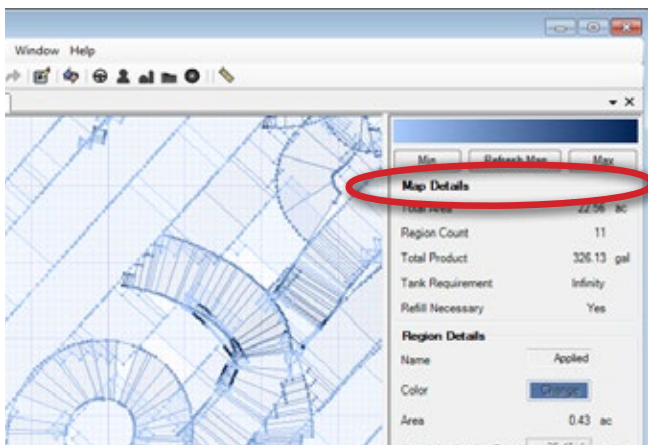

Region Details

The region details section displays name, region color, region area, region application rate and region's total applied product. Click on a region from the Bottom Tabs to see details.

Figure 115: Region Details

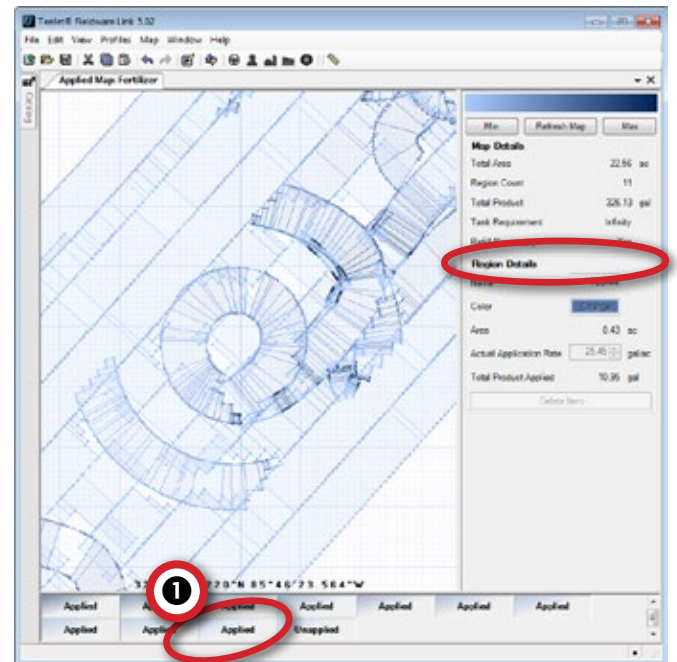

Delete

Select to delete all applied data in the current job profile.

Figure 116: Delete

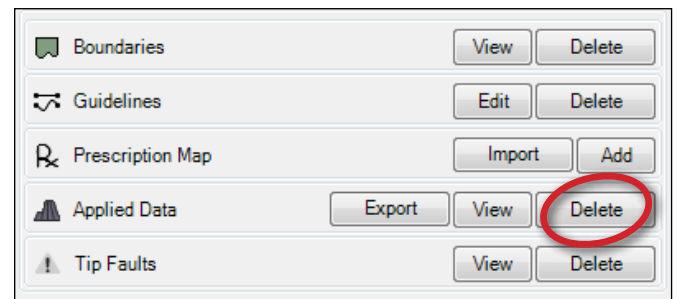

TIP FAULTS MAP

When a Tip Flow Monitor Kit is present on an Aeros system, a Tip Flow Monitor is available. After the tips are balanced, the system will monitor all the tips and their the flow rate if their respective boom section is turned on. The flow rate of each tip must be within the percentage range. If any tip is outside this range, an error will be generated, and the user will need to inspect the tip that is at fault. These faults are recorded and available to be viewed on a map.

- ▶ View – select to view the tip faults on a map and use the Measure Distances tool
- ▶ Delete – select to delete all tip faults in the current job profile

View

Select to view the tip faults on a map.

Figure 117: View

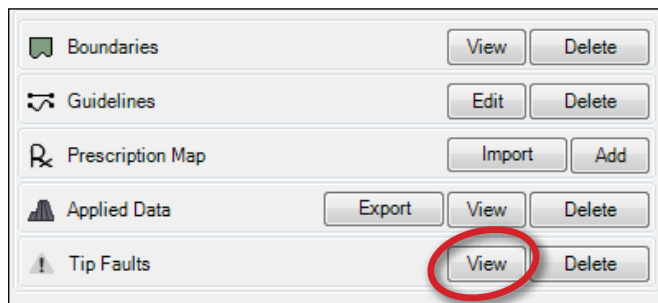
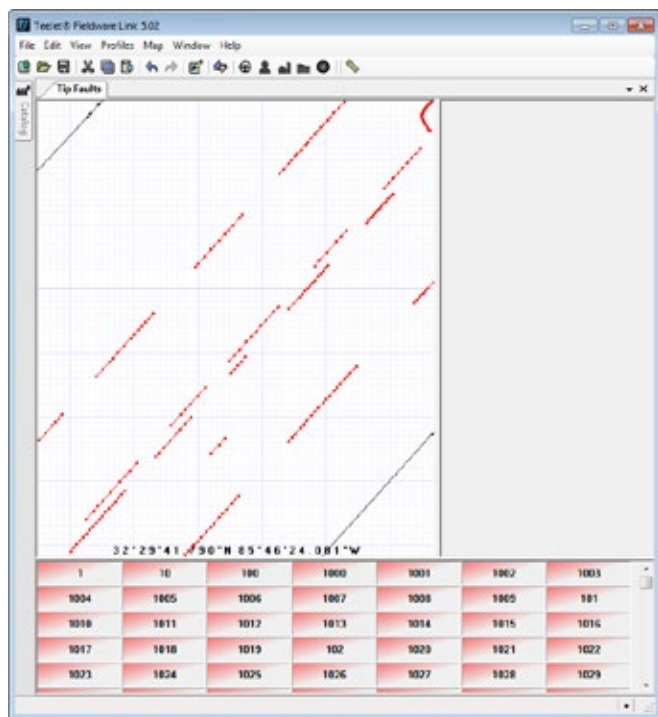

Figure 118: Tip Faults Map



Measure Distances Tool

Select to measure distances on the boundary map.

Figure 119: Measure Distances Tool

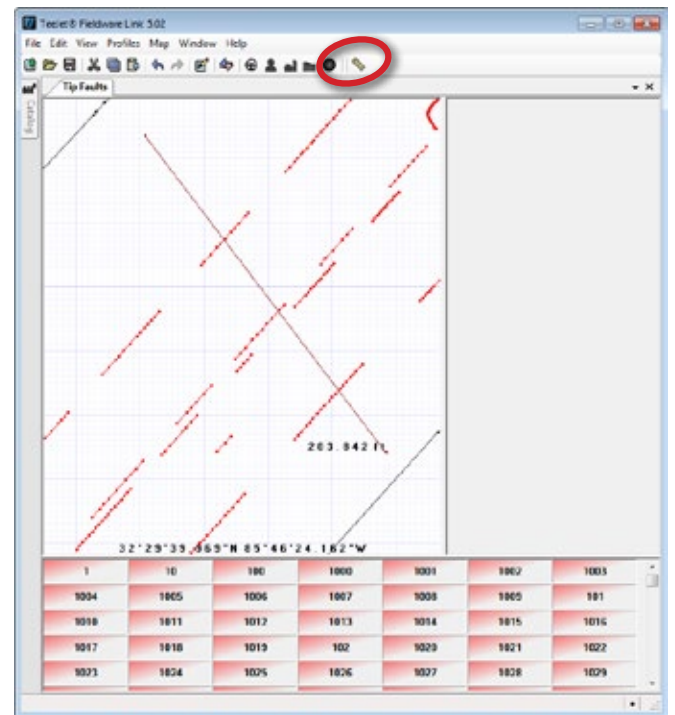

Delete

Select to delete all tip faults in the current job profile

Figure 120: Delete

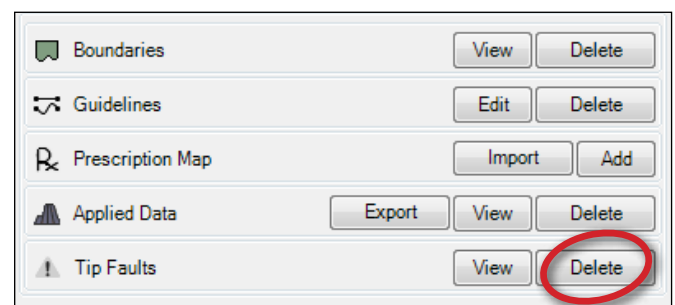

MAPS ON A CONSOLE

GNSS-based product application mapping is available on the Matrix Pro GS or Aeros in Vehicle View or Field View, in any guidance mode when a rate controller is on the system. Mapping can record areas covered by the implement (Coverage) or how much product has been applied and where (Application), and can direct single- and variable-rate product application (Preset Target Rate and Prescription, respectively).

- ▶ Coverage Map [viewable as part of the application map] – shows areas covered by the implement, regardless of whether product was applied
- ▶ Prescription Map – pre-loaded map that provides information to the rate controller for use in applying product
- ▶ Application Map – shows how much product has been applied and where, using color to indicate level in proportion to preset or automatically set maximum and minimum levels
- ▶ Target Rate Map [not available to be seen in Fieldware Link] – shows the application rate that the rate controller attempted to achieve at each location

Boundaries, guidelines, applied data, and prescription mapping can be copied from one job to another, eliminating the need to re-record field boundaries and information. The ability to reuse guidelines means work patterns and directions can be duplicated exactly for subsequent jobs.

APPENDIX A – CONFIGURATION SETTINGS

This appendix lists the Matrix Pro console, Aeros console, and Fieldware Link software menu settings, and also provides the following:

- Settings that can be made in the Matrix Pro console, Aeros console, or using the Fieldware Link software.
- Settings that are included when exported to a profile from the Matrix Pro console, Aeros console, or using the Fieldware Link software.

Symbol Key

In the following tables, these symbols indicate whether settings are available during an active Job:

- ✓ Available
- ✗ Not Available
- ◀ Retained from console with profile
- ▶ Retained from Fieldware Link with profile

Configuration Settings

Configuration Settings		Can be edited in			Saved to exported profile in		
		Matrix Pro	Aeros 9040	Fieldware Link	Matrix Pro	Aeros 9040	Fieldware Link
	Machine Type	✓	✓	✗	✓	✓	◀
	GNSS Antenna Height.....	✓	✓	✓	✓	✓	✓
	Implement Type	✓	✓	✓	✓	✓	✓
	Symmetric Implement Layout.....	✓	✓	✓	✓	✓	✓
	Multiple Section Output Modules.....	v4.33 ▶	✓	✗	✓	✓	◀
	Number of Implement Sections	✓	✓	✓	✓	✓	✓
	Guidance Width.....	✓	✓	✓	✓	✓	✓
	Application/Working Width.....	✓	✓	✓	✓	✓	✓
	Droplet Size Monitor.....	✓	✓	✗	✓	✓	◀
Tip Selection	Current Tip.....	✓	✓	✗	✓	✓	◀
	Tip Preset.....	✓	✓	✗	✓	✓	◀
	Tip Spacing.....	✗	✓	✗	✗	✓	◀
	Ground Speed Override	✗	◀ v4.21	✗	✗	✓	◀
	Applied Alert	✓	✓	✗	✓	✓	◀
	Entry Time	✓	✓	✗	✓	✓	◀
	Exit Time.....	✓	✓	✗	✓	✓	◀
	Allow BoomPilot In Reverse	✓	✓	✗	✓	✓	◀
	BoomPilot Start Mode.....	✓	✓	✗	✓	✓	◀
	BoomPilot Icon	✓	✓	✗	✓	✓	◀
Implement	Reverse Signal Delay	✓	✓	✗	✓	✓	◀
Straight Mode	In-Line Implement Offset Direction	✓	✓	✓	✓	✓	✓
	In-Line Implement Offset Distance	✓	✓	✓	✓	✓	✓
	Lateral Implement Offset Direction.....	✓	✓	✓	✓	✓	✓
	Lateral Implement Offset Distance	✓	✓	✓	✓	✓	✓
	Connection Point In-Line Offset Direction	✗	v4.31 ▶	✗	✗	✓	◀
	Connection Point In-Line Offset Distance.....	✗	v4.31 ▶	✗	✗	✓	◀
	Connection Point Lateral Offset Direction	✗	v4.31 ▶	✗	✗	✓	◀
	Connection Point Lateral Offset Distance.....	✗	v4.31 ▶	✗	✗	✓	◀
	Overlap	✓	✓	✓	✓	✓	✓
	Delay On/Off Times	✓	✓	✓	✓	✓	✓
Spreader Mode	Setup Type: TeeJet	✓	✓	✓	✓	✓	✓
	Antenna to Disks Distance	✓	✓	✓	✓	✓	✓
	Lateral Implement Offset Direction	✓	✓	✓	✓	✓	✓
	Lateral Implement Offset Distance	✓	✓	✓	✓	✓	✓
	Overlap.....	✓	✓	✓	✓	✓	✓
	Delay On/Off Times	✓	✓	✓	✓	✓	✓
	Spread Offset Distance	✓	✓	✓	✓	✓	✓
	Section Offsets	✓	✓	✓	✓	✓	✓
Section Lengths.....	✓	✓	✓	✓	✓	✓	

 Configuration Settings		Can be edited in			Saved to exported profile in		
		Matrix Pro	Aeros 9040	Fieldware Link	Matrix Pro	Aeros 9040	Fieldware Link
Implement (continued)	Spreader Setup Type: OEM	✓	✓	✓	✓	✓	✓
	Mode Antenna to Disks Distance	✓	✓	✓	✓	✓	✓
	(continued) Lateral Implement Offset Direction	✓	✓	✓	✓	✓	✓
	Lateral Implement Offset Distance	✓	✓	✓	✓	✓	✓
	Start/Stop Distances	✓	✓	✓	✓	✓	✓
	Section Start/Stop Offsets	✓	✓	✓	✓	✓	✓
	Staggered In-line Section 1 Offset Direction	✓	✓	✓	✓	✓	✓
	Mode In-line Section 1 Offset Distance	✓	✓	✓	✓	✓	✓
	Lateral Implement Offset Direction	✓	✓	✓	✓	✓	✓
	Lateral Implement Offset Distance	✓	✓	✓	✓	✓	✓
	Overlap	✓	✓	✓	✓	✓	✓
	Delay On/Off Times	✓	✓	✓	✓	✓	✓
Section Offsets	✓	✓	✓	✓	✓	✓	
Mapping and Guidance	Mapping Location	v4.31 ▶	v4.31 ▶	✘	✓	✓	◀
	Location Name	v4.31 ▶	v4.31 ▶	✘	✓	✓	◀
	Mapping Location In-Line Offset Direction	v4.31 ▶	v4.31 ▶	✘	✓	✓	◀
	Mapping Location In-Line Offset Distance	v4.31 ▶	v4.31 ▶	✘	✓	✓	◀
	Mapping Location Lateral Offset Direction	v4.31 ▶	v4.31 ▶	✘	✓	✓	◀
	Mapping Location Lateral Offset Distance	v4.31 ▶	v4.31 ▶	✘	✓	✓	◀
	Guidance Width	✓	✓	✓	✓	✓	✓
	Guidance Sensitivity	✘	v4.11 ▶	✘	✓	✓	◀
	Display Mode	v4.11 ▶	✘	✘	✓	✓	◀
	LED Spacing	v4.11 ▶	✘	✘	✓	✓	◀
	External Lightbar	v4.31 ▶	v4.31 ▶	✘	✓	✓	◀
	External Lightbar LED Brightness	v4.31 ▶	v4.31 ▶	✘	✓	✓	◀
External Lightbar Text Brightness	v4.31 ▶	v4.31 ▶	✘	✓	✓	◀	
External Cross Track	v4.31 ▶	v4.31 ▶	✘	✓	✓	◀	
External Swath Number	v4.31 ▶	v4.31 ▶	✘	✓	✓	◀	
External Speed	v4.31 ▶	v4.31 ▶	✘	✓	✓	◀	
External Actual Rate	v4.31 ▶	v4.31 ▶	✘	✓	✓	◀	
External Target Rate	v4.31 ▶	v4.31 ▶	✘	✓	✓	◀	
External Applied Product	v4.31 ▶	v4.31 ▶	✘	✓	✓	◀	
Sensors	IOM Pressure Maximum Pressure Rating	✓	✓	✓	✓	✓	✓
	Sensor Low Pressure Alarm	✓	✓	✓	✓	✓	✓
	High Pressure Alarm	✓	✓	✓	✓	✓	✓
Tip Flow Monitor	Tip Alarm Percentage	✘	✓	✘	✘	✓	◀
	Tip Alarm Delay	✘	✓	✘	✘	✓	◀
	Number of Sections	✘	✓	✘	✘	✓	◀
	Number of Tips per Section 1–30	✘	✓	✘	✘	✓	◀
	Tip Balance Percentage	✘	✓	✘	✘	✓	◀
Tip Flow Monitor Balance	✘	✓	✘	✘	✓	◀	
ISOBUS	Machine Speed Broadcast	✘	v4.31 ▶	✘	✘	✓	◀
	Navigation Speed Broadcast	✘	v4.31 ▶	✘	✘	✓	◀
	Ground Speed Broadcast	✘	v4.31 ▶	✘	✘	✓	◀
	Speed Broadcast	✘	◀v4.21	✘	✘	✓	◀
	Time/Date Broadcast	✘	v4.11 ▶	✘	✘	✓	◀
	Universal Terminal (UT) Number	✘	v4.11 ▶	✘	✘	✓	◀
	Task Controller (TC) Number	✘	v4.11 ▶	✘	✘	✓	◀
	Number of UT Object Pools	✘	v4.11 ▶	✘	✘	✓	◀
Number of Isobus Control Functions	✘	v4.11 ▶	✘	✘	✓	◀	

 Configuration Settings		Can be edited in			Saved to exported profile in				
		Matrix Pro	Aeros 9040	Fieldware Link	Matrix Pro	Aeros 9040	Fieldware Link		
Control Channels	Device Setup	Dual Control Module (DCM) 1	x	◀ v4.21	x	x	✓	x	
		Product Control Channel 1	x	◀ v4.21	✓	x	✓	✓	
		TankMatic	x	◀ v4.21	✓	x	✓	✓	
		Product Control Channel 1*							
		TankMatic	Sensor Type	x	◀ v4.21	✓	x	✓	✓
			Minimum Tank Content.....	x	◀ v4.21	✓	x	✓	✓
		Maximum Tank Content.....	x	◀ v4.21	✓	x	✓	✓	
		Automatic Filling Offset.....	x	◀ v4.21	✓	x	✓	✓	
Product		Product Name.....	✓	✓	✓	✓	✓	✓	
		Actual Tank/Bin Amount.....	x	◀ v4.21	✓	x	✓	✓	
		Target Application Rate Preset #1-3	x	◀ v4.21	✓	x	✓	✓	
		Tip Constant	x	x	✓	▶	▶	✓	
		Product Density	x	◀ v4.21	x	x	✓	▶	
		Application Rate Step.....	x	◀ v4.21	x	x	✓	▶	
		Maximum Rate Color.....	✓	✓	x	✓	✓	▶	
		Minimum Rate Color.....	✓	✓	x	✓	✓	▶	
		Color Range	✓	✓	x	✓	✓	▶	
		Applied Rate Mapping Upper Limit.....	✓	✓	x	✓	✓	▶	
	Applied Rate Mapping Lower Limit.....	✓	✓	x	✓	✓	▶		
AutoSteer		Assisted/Auto Steering Enabled/Disabled	✓	✓	x	✓	✓	▶	
	Valve Setup	Valve Type	✓	✓	x	✓	✓	▶	
		Valve Frequency	✓	✓	x	✓	✓	▶	
		Minimum Left/Right Duty Cycle	✓	✓	x	✓	✓	▶	
		Maximum Left/Right Duty Cycle	✓	✓	x	✓	✓	▶	
	Steering Settings	Coarse Steering Adjustment.....	✓	✓	x	✓	✓	▶	
		Fine Steering Adjustment	✓	✓	x	✓	✓	▶	
		Deadband	✓	✓	x	✓	✓	▶	
		Lookahead.....	✓	✓	x	✓	✓	▶	
		Valve Test	✓	✓	x	✓	✓	▶	
	Valve Diagnostics	✓	✓	x	✓	✓	▶		
	Options	Steering Wheel Sensor.....	✓	✓	x	✓	✓	▶	
	Steering	Enabled/Disabled	✓	✓	x	✓	✓	▶	
	Angle	Sensor Calibration	✓	✓	x	✓	✓	▶	
	Sensor	On Line Calibration.....	✓	✓	x	✓	✓	▶	
Tilt Correction		Enabled/Disabled	✓	✓	x	✓	✓	▶	
		Field Level	✓	✓	x	✓	✓	▶	

APPENDIX B – SUPPORTED FMIS DATA DETAILS

The Fieldware Link application only supports the following FMIS prescription file formats:

- ISO-11783 ISOXML
- Mid-Tech/TeeJet ARM
- ESRI Shapefile (SHP)

ISO-11783 Part 10 ISOXML - “TASKDATA”

Fieldware Link can convert version 2.0 ISOXML prescription data into TeeJet Job format if it conforms to the following rules:

- ▶ Prescription data are single product only.
 - TASKDATA.xml files with multiple products assigned to a Treatment zone will only select and convert the first one encountered.
- ▶ TASKDATA.xml files may contain multiple single product prescription tasks (<TSK's).
 - Each <TSK found during the conversion process will get placed into a new unique Job within the TeeJetData folder structure.
- ▶ TASKDATA.xml prescription data supports the following:
 - Grid Type 1
 - Polygon based
 - Grid Type 2 with less than 255 unique rate values found in the Task's PDV elements.
- ▶ No limit to the number of polygons as long as the Grid Type 1/ Polygon unique rate limit of 255 is followed.
- ▶ Partfield Boundary elements are supported for all Part 10 versions up to 4.0.
 - This means the <PFD element's boundary description is supported for single bounding polygons with multiple parts or for multiple single boundary polygons assigned to a single <PFD element.
- ▶ “Straight Rate” Treatment Zone prescriptions that do not contain a <PLN or <GRD reference within the <TSK - <TZN are NOT supported.
 - Therefore, if a valid TASKDATA file includes a <TSK with a <TZN and uses the implied boundary polygon of the <PFD object, Fieldware Link will NOT attempt to convert it. Users must export a valid <TSK with a valid <TZN and <PLN.
- ▶ Only “Mass” and “Volume” based prescription Unit types are supported.
 - DDI's 0001 and 0006 in the <PDV elements
 - It should be understood that if other DDI's are found they will be converted and a Job created, it is that the target TeeJet console will NOT understand what to do as only DDI's 0001 and 0006 are handled.

- ▶ No attempt is made to fully comply with the 11783 Part 10 workflow.
 - Coding data are NOT maintained.
- This conversion is for prescription file support on the target TeeJet console only.
- Any generated Job tasks will not push their data into the console's system TASKDATA.xml file, and therefore, you should NOT expect to have all data when the Job is transferred out of the system after completion.

Mid-Tech/TeeJet ARM

Fieldware Link can convert Mid-Tech/TeeJet ARM data into TeeJet Job format if it conforms to the following rules:

- ▶ Single Product only
 - If more than one product exists within the ARM file it will be ignored.
- ▶ Must contain less than 255 unique rate values.
 - No limit to the number of polygons.

ESRI Shapefile (SHP)

Fieldware Link can convert ESRI Shapefile (SHP) data into TeeJet Job format if it conforms to the following rules:

- ▶ Single Product only.
 - Single Product SHP files must contain less than 254 unique rate values. (see TASKDATA.xml limits above for details)
 - No limit exists on the number of polygons, same as with TASKDATA.xml.
- ▶ SHP data must be in WGS84 Latitude-Longitude coordinates.
- ▶ SHP data must exist as a group of files of the same name and differing extensions.
 - Fieldware Link MUST have:
 - .SHP
 - .SHX
 - .DBF
 - The projection file (.PRJ) is optional, however, if present can only exist as the single form for GEOGCS WGS84.
 - GEOGCS[“GCS_WGS_1984”,DATUM[“D_WGS_1984”,SPHEROID[“WGS_1984”,6378137,298.257223563]],PRIMEM[“Greenwich”,0],UNIT[“Degree”,0.017453292519943295]]
 - All other SHP files will be ignored.

- ▶ The .DBF file must contain at least one field (table column) of numeric data linked to the .SHP polygons.
 - If more than one field of numeric data exists, the user will only be allowed to choose one.
 - If a Product Field exists with different Product names defined, only the first encountered name will be accepted.
 - ▶ The recommended .DBF file structure should contain three fields with the following labels:
 - Prod_Name
 - Prod_Unit
 - Prod_Rate
- See Appendix C for more details
- ▶ The Fieldware Link SHP file function does not handle Boundary Polygons in SHP format.
 - Such data will be ignored.
 - ▶ The Jobs created from SHP files are the prescriptions only. No boundaries.

Supported DBF Unit Type Abbreviations

The list below is strictly defined. The unit type column in the DBF file must match one of the below exactly in order to be utilized.

Volume
MetersCubed
Gallons
ImpGallons
FluidOunces
Liters
Quarts
FeetCubed
YardCubed

The unit type must be a ratio separated by a '/' character.

Some examples of proper unit types are:

- Gallons/Acres
- Kilograms/Hectares
- Liters/MetersSquared
- etc...

Mass
Grams
Pounds
Kilograms
Ounces
Ton
Tonne

Area
MetersSquared
Acres
Hectares
KilometersSquared
FeetSquared
Feet1KSquared
MilesSquared

Supported DBF Table Descriptions

Table 1: Example of minimal populated DBF in pseudo-table format:

Prod_Rate
15
15
0
15

The preferred contents of the DBF file should indicate the Product Name, Product Unit Type and Product rate information as pre-defined fields.

Table 2: Example of completely populated DBF in pseudo-table format:

Obj_ID	Shape	Prod_Name	Prod_Unit	Prod_Rate
1	polygon	Roundup Pro™	Gallons/Acres	15
2	polygon	Roundup Pro™	Gallons/Acres	15
3	polygon	Roundup Pro™	Gallons/Acres	0
4	polygon	Roundup Pro™	Gallons/Acres	15

The ObjID and Shape fields in the above table are surrogates for the ESRI "Attribute Table" view of the .DBF file.

Refer to Appendix B for Unit Type designators within the DBF file.

Supported Custom Unit Type Abbreviations

The list below is directly taken from Bugzilla PR 10400. It applies only to custom unit types, and the values may be translated.

Volume	Mass
Liters/Hectare	Kg/Hectare
Liters/Acre	Kg/Acre
Gallons/Acre	Metric Ton/Hectare
Gallons/1k SqFt	Pounds/Acre
fl oz/Acre	Pounds/1k SqFt
fl oz/1k SqFt	Ton/Acre (equal to "short tonnes/Acres")
	Ton/Hectare (equal to "short tonnes/Hectares")

APPENDIX C – ISO-11783 TASKDATA.XML EXAMPLE

Fieldware Link and Matrix PRO GS Guide

Instructions for using Fieldware Link to prepare jobs for VRA applications using ISOXML prescription files, Matrix Pro GS consoles, and compatible rate controllers. While Fieldware Link can be used to create detailed Machine profiles that can be transferred into Matrix Pro GS consoles, these instructions detail the minimum requirements to create jobs in Fieldware Link. The basic Machine profiles used in these examples will be transferred to the USB Drive when the VRA jobs are exported, but they should not be transferred/loaded into the Matrix Pro GS console. As an alternative, power users are welcome to build complete Machine profiles in Fieldware Link, use those profiles to create VRA jobs, and load both the Machine profiles and jobs into their Matrix Pro GS console.

Requirements:

- The TASKDATA.xml file to be imported can only contain a single (1) TSK.
 - If the TASKDATA.xml file contains more than one TSK, use Fieldware Convert to first create the desired Jobs.
- Please use Fieldware Link v5.02 or later for this work.
- It is recommended that the Matrix Pro GS console be running v4.30 or later.
- The Matrix Pro GS must be unlocked for the function 'Rate Control'.
- The Matrix Pro GS setting Configuration->Data->Options\Job Mode must be set to 'Advanced' in order to allow VRA applications.

1. BUILD A BASIC DRY FERTILIZER AND/OR BASIC LIQUID APPLICATOR/SPRAYER MACHINE PROFILE

NOTE: The "Application Type" MUST be set properly prior to importing the prescription file.

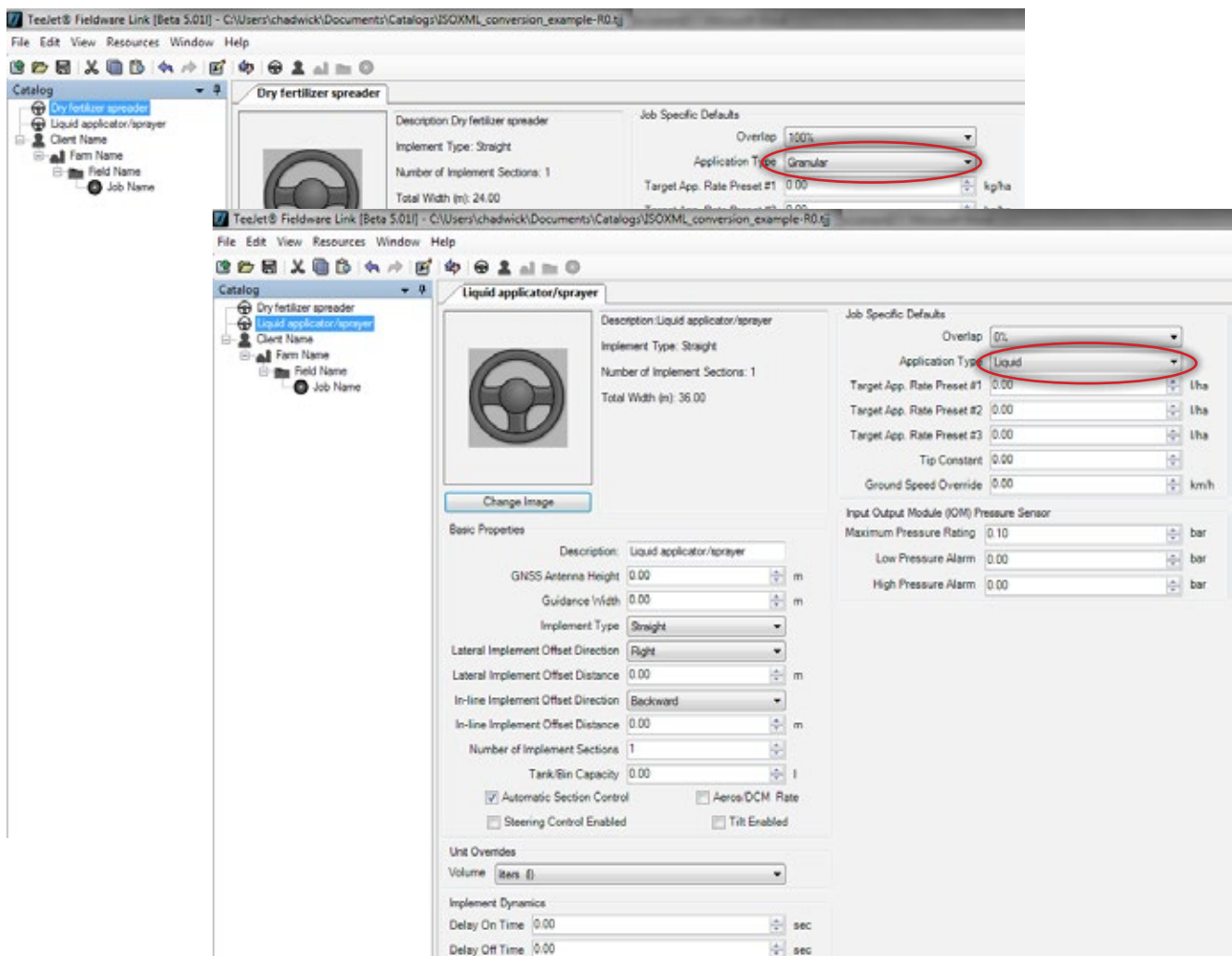

2. BUILD THE CLIENT/FARM/FIELD STRUCTURE

All jobs in Fieldware Link are organized in the industry standard Client/Farm/Field hierarchy. Build this structure as shown below, naming each Object in a manner that is easy for the user to recognize. Repeat as necessary for multiple Clients, Farms, and Fields. None of the values within each of the Client/Farm/Field tabs are critical or required to build a VRA job.

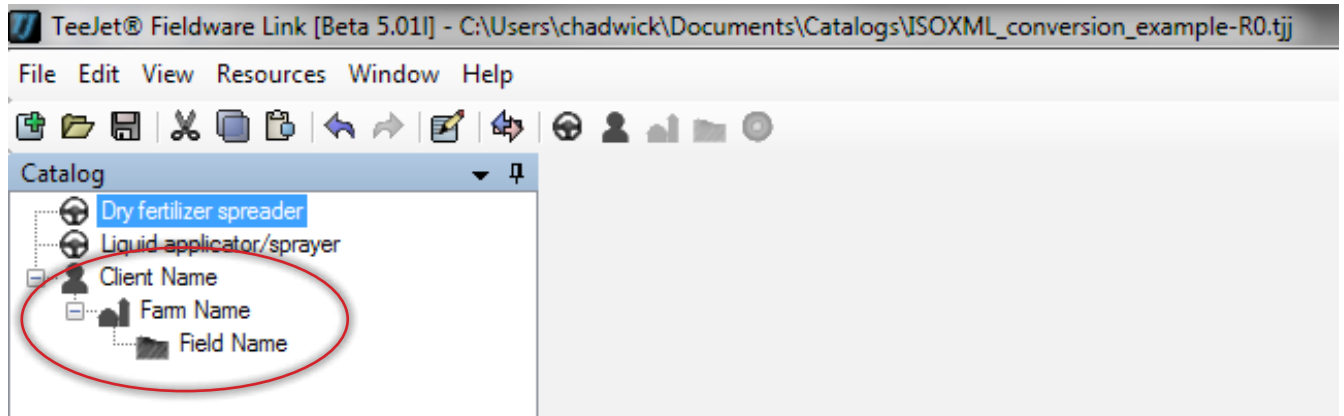

3. CREATE A JOB

Create a job within the appropriate field. It is critical at this point that the 'Machine Settings' selected is appropriate for the application planned. If the application will be for a dry fertilizer material, the machine selected from Step 1 above must be a dry fertilizer (granular) machine. If the application will be for a liquid material, the machine selected from Step 1 above must be a liquid applicator/sprayer.

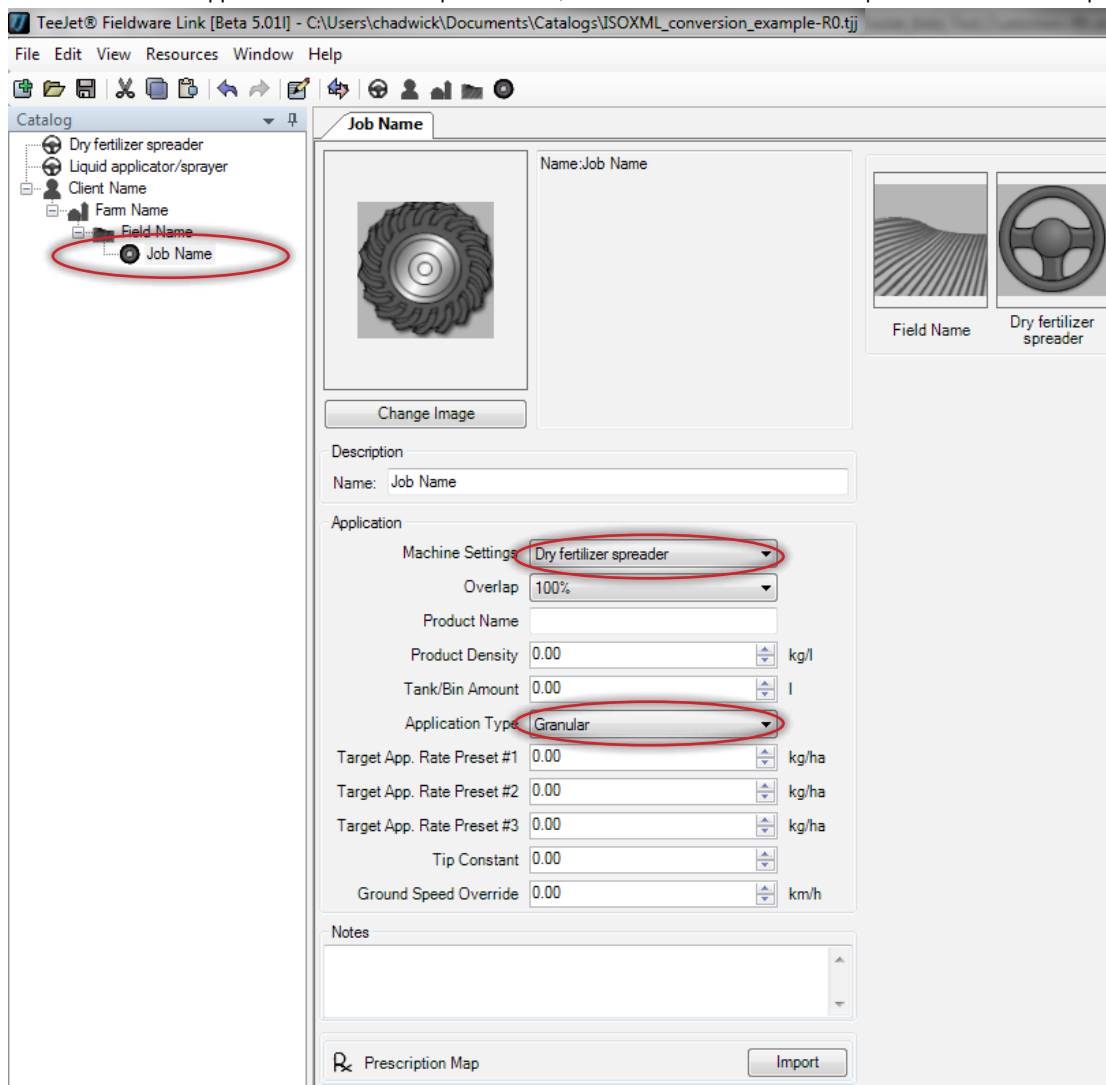

4. IMPORT THE ISOXML PRESCRIPTION FILE

Click on the 'Prescription Map' 'Import' button and navigate in Windows to the location where you have saved the ISOXML prescription files sent from your FMIS provider. Be sure to select 'ISOXML (taskdata.xml)' in the drop-down box to the right of the 'File name' selection box. The file you select will be named TASKDATA.XML.

Once selected, click on 'Open'.

NOTE: ISOXML files are commonly sent from the provider in a zipped file format. It is critical that you unzip (Extract) the zipped files before attempting to import them into Fieldware link. If you see the message 'The map you are attempting to open has no useable data' it is quite possibly because the files you are importing are still in a zipped format. Unzip (Extract) the files and try the import again.

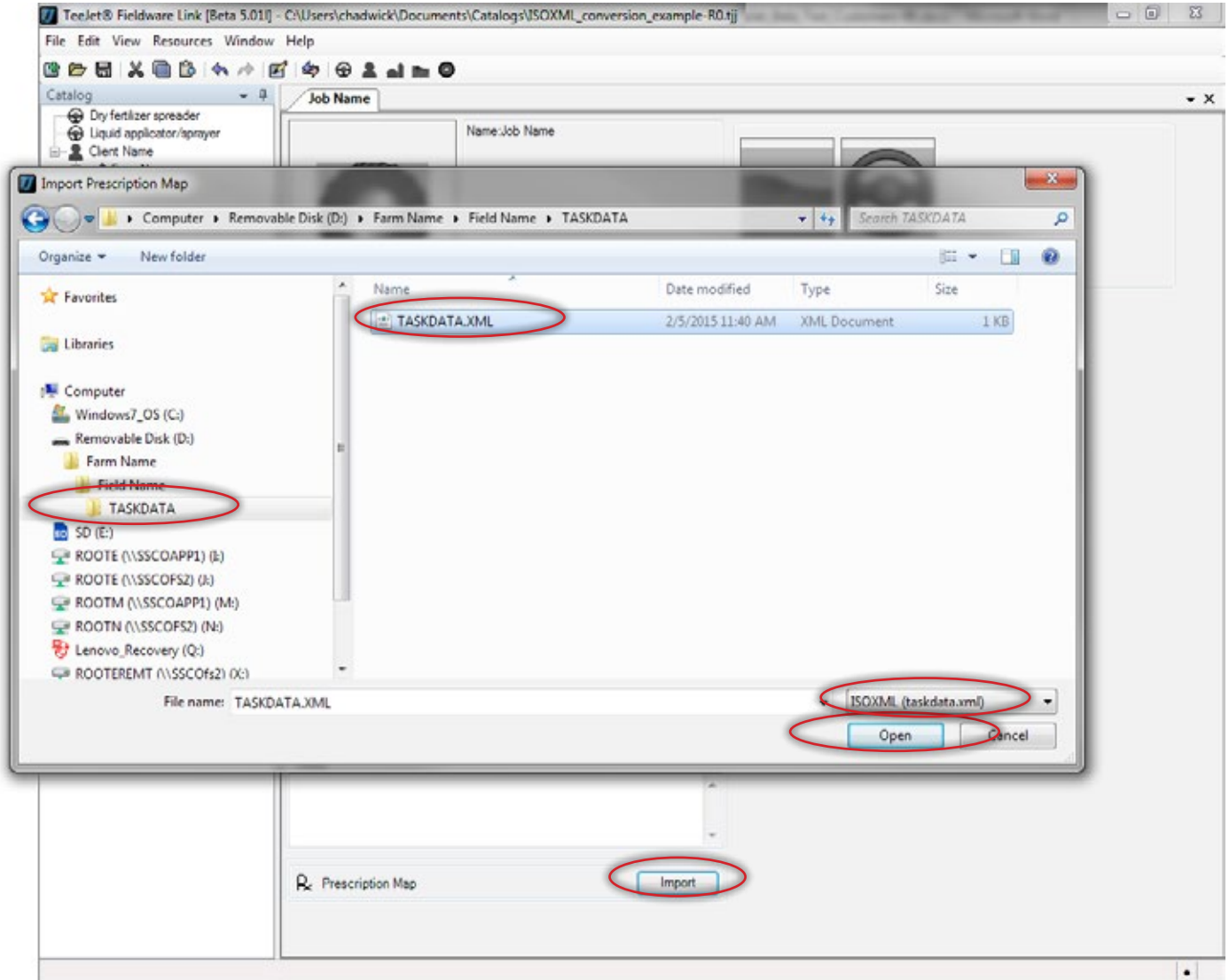

5. VERIFY THAT THE ISOXML FILE IMPORTS CORRECTLY AND THAT THE RATES ARE AS EXPECTED

The imported map appearance will vary depending on how it was produced by your FMIS provider. Click on the tabs at the bottom of the map, and verify that the rates shown in the right side panel are as expected.

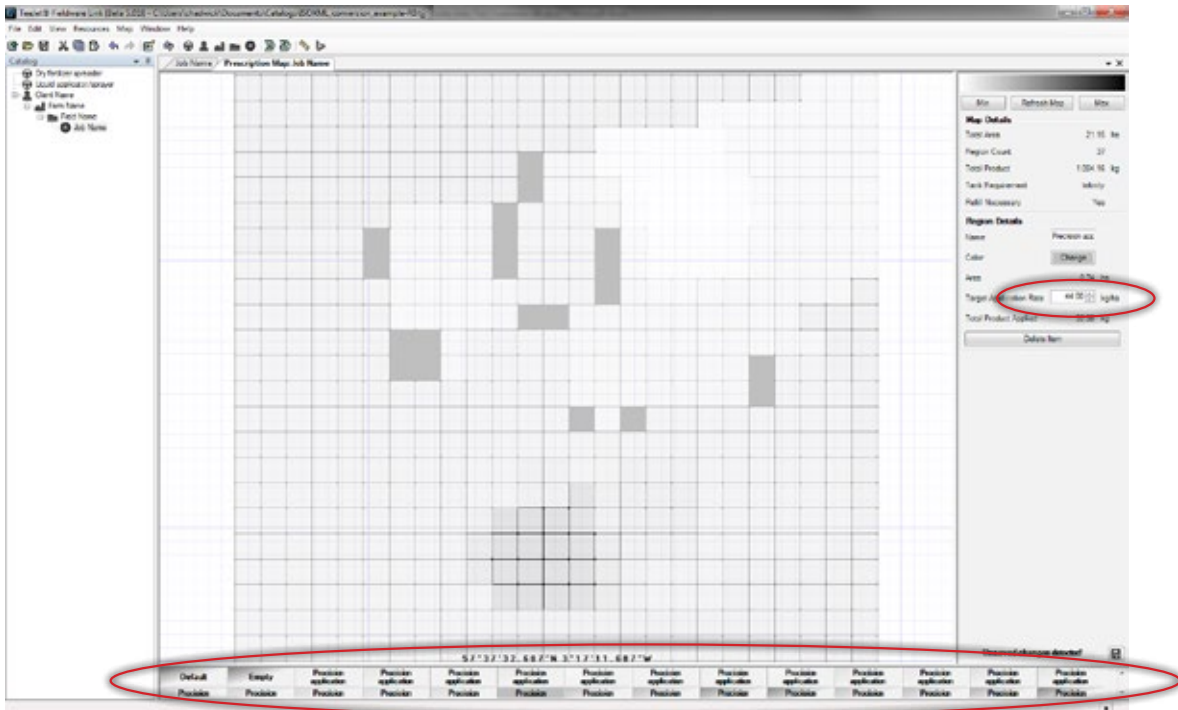

6. PREPARE TO EXPORT THE JOB TO A USB DRIVE

Click on the 'Port Profiles' to open the port window. Select the drive letter for the USB Drive (Thumb Drive) location on your computer that you want to port the job to. Be very sure to select 'Aeros or Matrix 570/840 v4.00' in the 'Console' drop-down box. Click OK.

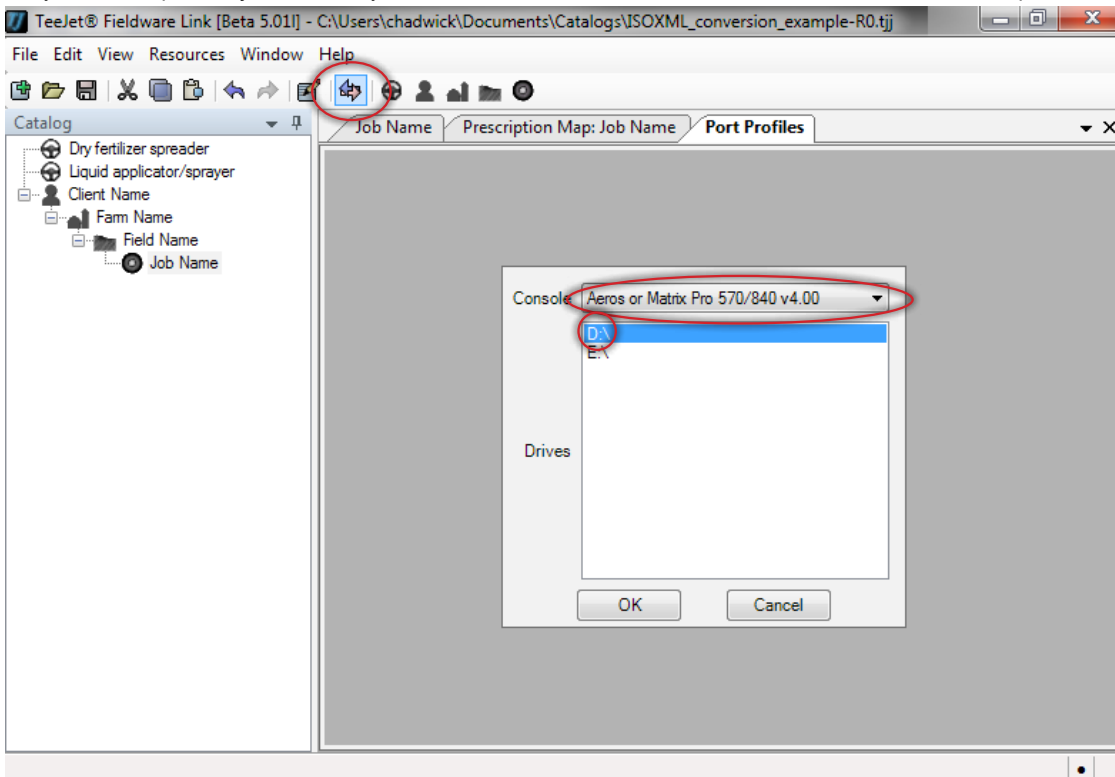

7. EXPORT JOB TO USB DRIVE

In the left pane select the job that you wish to export to the USB drive and click on the single right pointing brown arrow.

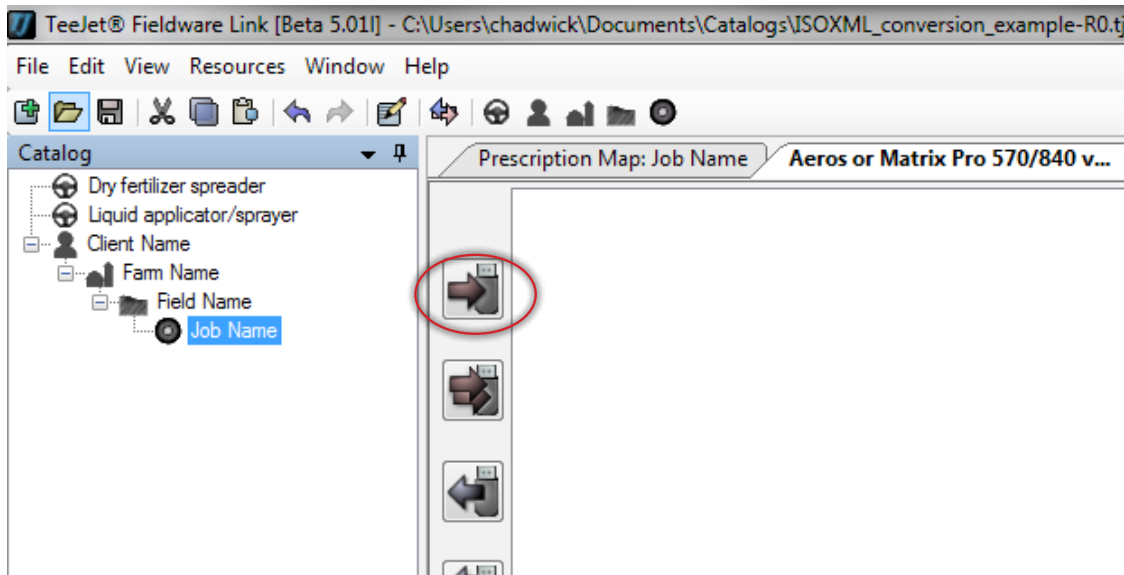

The job and appropriate Machine profile will now show in the right pane. Be very careful to click on the 'Done' button in the lower right corner of the right pane before removing the USB drive from the computer.

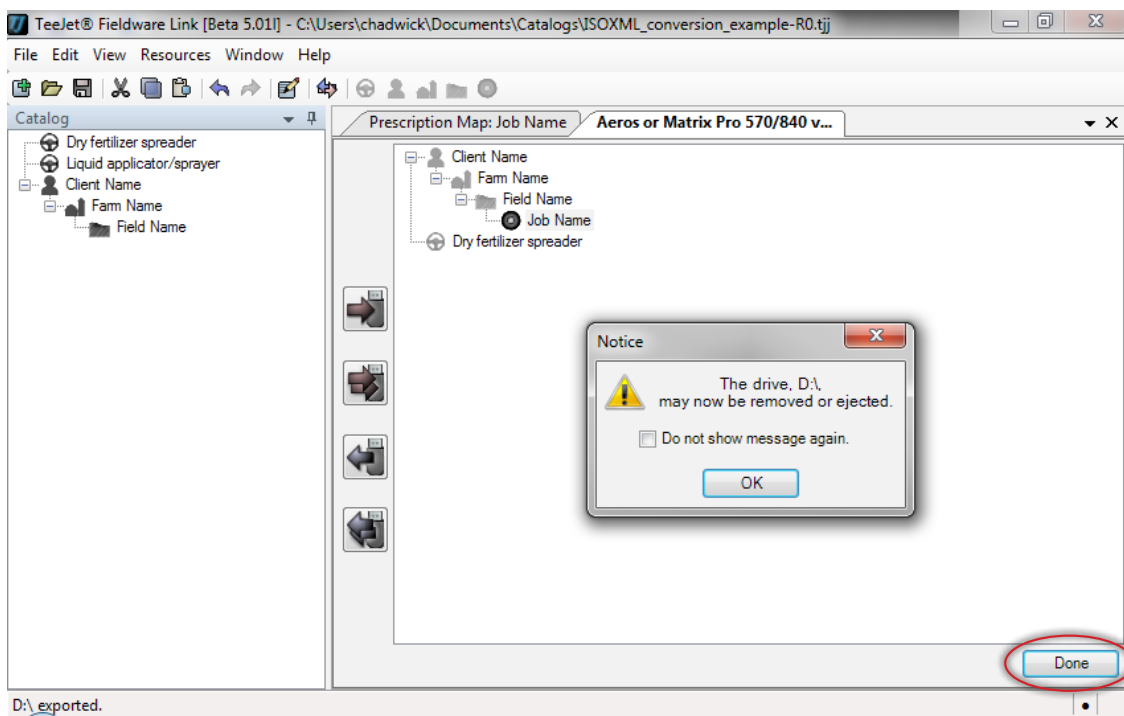

The following steps assume that the Matrix Pro GS already meets all the requirements listed at the start of this document, and that the GPS/GNSS and Implement configurations have already been set correctly for the application and implement being used.

8. IMPORT JOB INTO MATRIX PRO GS CONSOLE

Insert the USB Drive in the Matrix Pro GS console and navigate to Configuration->Data->Job Data->Transfer, and copy the job from 'USB Storage' to 'Internal Storage'

9. CONFIGURE MATRIX PRO GS FOR VRA (THIRD-PARTY RATE CONTROL)

Navigate to Configuration->Third-Party Rate Control, enable Third-Party Rate Control, and set each of the parameters as required for the controller. Your TeeJet contact may have to assist with this.

10. BEGIN APPLICATION

From the home page select the imported job from the 'Job' drop-down box, and begin the application.

FIELDWARE® LINK

U S E R M A N U A L

- Enhanced data organization with Fieldware Link application
 - Reuse guidelines and/or boundaries
 - Input job details such as names or images
 - Setup machine settings for specific vehicles and implements
 - Access and edit boundary, guideline, prescription, applied data and tip fault maps

MATRIX® PRO
MATRIX® PRO_{GS}
Aeros 9040



www.teejet.com

A Subsidiary of  **Spraying Systems Co.**

98-05244-EN R2 English
© TeeJet Technologies 2018