

# SENTRY 6141

## USER MANUAL

### ISOBUS Tip Flow Monitor

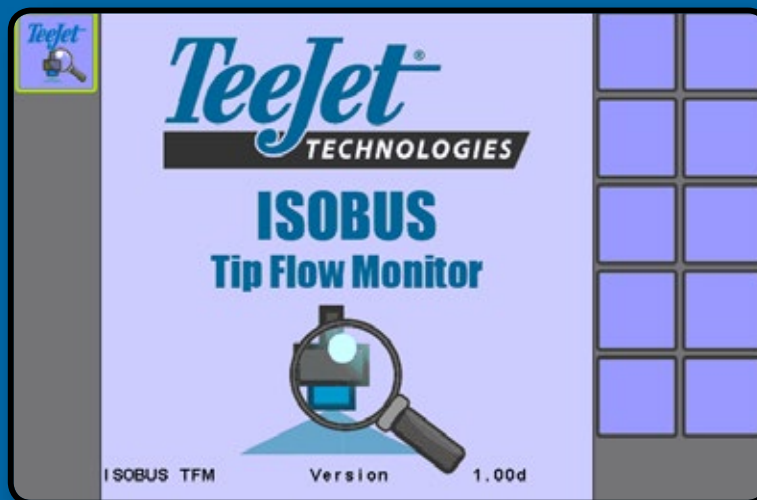

Software Version 1.00



A Subsidiary of  Spraying Systems Co.®

## **Copyrights**

© 2016 TeeJet Technologies. All rights reserved. No part of this document or the computer programs described in it may be reproduced, copied, photocopied, translated, or reduced in any form or by any means, electronic or machine readable, recording or otherwise, without prior written consent from TeeJet Technologies.

## **Trademarks**

Unless otherwise noted, all other brand or product names are trademarks or registered trademarks of their respective companies or organizations.

## **Limitation of Liability**

TEEJET TECHNOLOGIES PROVIDES THIS MATERIAL "AS IS" WITHOUT WARRANTY OF ANY KIND, EITHER EXPRESSED OR IMPLIED. NO COPYRIGHT LIABILITY OR PATENT IS ASSUMED. IN NO EVENT SHALL TEEJET TECHNOLOGIES BE LIABLE FOR ANY LOSS OF BUSINESS, LOSS OF PROFIT, LOSS OF USE OR DATA, INTERRUPTION OF BUSINESS, OR FOR INDIRECT, SPECIAL, INCIDENTAL, OR CONSEQUENTIAL DAMAGES OF ANY KIND, EVEN IF TEEJET TECHNOLOGIES HAS BEEN ADVISED OF SUCH DAMAGES ARISING FROM TEEJET TECHNOLOGIES SOFTWARE.

## Table of Contents

<b>PRODUCT OVERVIEW</b>	<b>1</b>
<b>SAFETY INFORMATION</b>	<b>1</b>
<b>COMPONENTS</b>	<b>2</b>
Boom Interface Module Harness Connection .....	4
<b>INSTALLATION</b>	<b>5</b>
<b>NOZZLE BODY WITH FLOW METER AND TIP SENSOR INTERFACE</b>	<b>5</b>
Flow Meter Assembly .....	5
<b>POWER</b>	<b>6</b>
Home Screen .....	6
<b>MAIN SETUP MODE</b>	<b>7</b>
<b>MACHINE</b>	<b>7</b>
Implement Parameters .....	7
<i>Tip Balance Allowance</i> .....	7
<i>Number of Boom Sections</i> .....	7
<i>Number of Tips per Section</i> .....	7
Alarm Configurations .....	8
<i>Tip Alarm Deviation Allowance</i> .....	8
<i>Tip Alarm Delay</i> .....	8
<b>USER INTERFACE</b>	<b>8</b>
User Preferred VT .....	8
<b>HELP</b>	<b>8</b>
Diagnostic .....	8
VT Data .....	8
TECU .....	9
About .....	9
<b>OPERATION</b>	<b>10</b>
<b>TIP BALANCE</b>	<b>10</b>
Initiating The Balancing Procedure .....	10
On Screen Indicators .....	11
Boom Sections .....	11
Status Box .....	11
Tip Flow Indicator .....	11
Buttons .....	11

# Sentry 6141 ISOBUS Tip Flow Monitor

---

## PRODUCT OVERVIEW

---

Congratulations on the purchase of your new ISOBUS Tip Flow Monitor built on the ISOBUS architecture. When used within the guidelines of this manual, the ISOBUS Tip Flow Monitor controller will be a reliable application tool.

This manual covers the functions of the ISOBUS Tip Flow Monitor.

Use with your existing UT

- Works seamlessly and displays on any ISOBUS UT
- Easy navigation menu and data rich display
- Automatic boom section control upgrade option
- Variable rate control available providing your UT has GPS and task control capability
- Add additional ISOBUS ECUs as your needs change
- Provides basic rate control
- Standardized plugs, cables and software simplify installation and connectivity and result in true “plug and play” technology. ISOBUS Tip Flow Monitor resides on the implement, reducing hardware in the cab

*Figure 1: ISOBUS Tip Flow Monitor Job Computer & Sample Console*

---

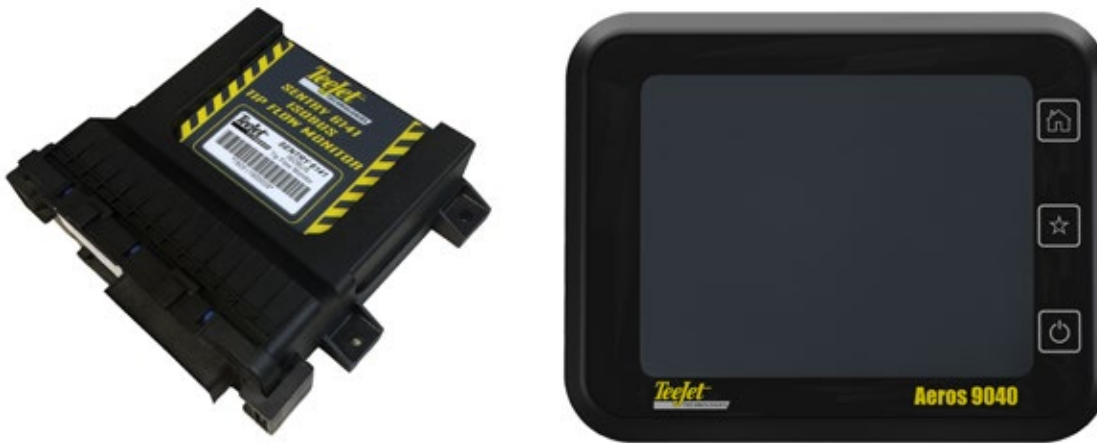

## SAFETY INFORMATION

---

TeeJet Technologies is not responsible for damage or physical harm caused by failure to adhere to the following safety requirements.

As the operator of the vehicle, you are responsible for its safe operation.

The Sentry 6141 ISOBUS Tip Flow Monitor is not designed to replace the vehicle's operator.

The Sentry 6141 ISOBUS Tip Flow Monitor is designed to support and improve efficiency while working in the field. The driver has full responsibility for the quality and work related results.

Photos and illustrations may vary from the actual components provided. This may be due to different installation options, operation modes or production models.

Always try to use original parts. Built to the highest standards of safety and reliability, TeeJet Technologies parts are to be used for this system as others might jeopardize the safety and function of the system. TeeJet is not responsible for any redesign or adaptations of the Sentry 6141 ISOBUS Tip Flow Monitor. Any changes to the Sentry 6141 ISOBUS Tip Flow Monitor voids the company warranty.

# Sentry 6141 ISOBUS Tip Flow Monitor

## COMPONENTS

Unpack the installation kit and identify the required parts for your installation.

Item	Part Number	Description	Quantity
A	78-05119	ISOBUS Tip Flow Monitor.....	1
B	45-09037	ISOBUS Tip Flow Monitor Interface (TFMI) Harness.....	1
C	78-05091	Boom Interface Module (BIM).....	1
D	45-10142*	Boom Interface Module (BIM) Harness .....	1
E	varies	Harness to Tip Sensor Interface Extension Cable..... varies 45-05857: 3'/1 m, 45-05858: 6'/1.8 m, 45-05859: 12'/3.6 m, 45-05864: 35'/10.7 m	
F	78-05104	Tip Sensor Interface.....	varies
G	78-05105	Dual Tip Sensor Interface .....	varies
H	57-00122	Nozzle Flow Meter .....	varies
I	45-05856	Terminator, End (Male) .....	1
J	45-05855	Terminator, Start (Female) .....	1

\*Actual harness may be machine specific.

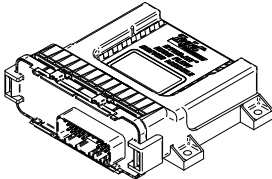
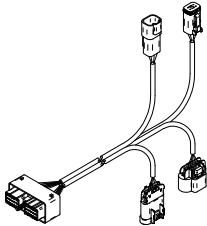
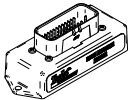
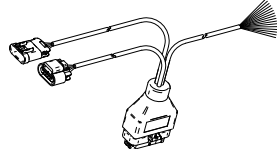
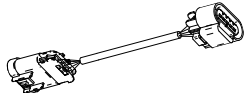
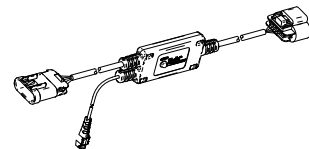
Item	Part #	Description	Illustration
A	75-05119	ISOBUS Tip Flow Monitor	
B	45-09037	ISOBUS Tip Flow Monitor Interface (TFMI) Harness	
C	78-05091	Boom Interface Module (BIM)	
D	45-10142	Boom Interface Module (BIM) Harness (Actual harness may be machine specific.)	
E	45-05857: 3'/1 m, 45-05858: 6'/1.8 m, 45-05859: 12'/3.6 m, 45-05864: 35'/10.7 m	Harness to Tip Sensor Interface Extension Cable	
F	78-05104	Single Tip Sensor Interface	

# Sentry 6141 ISOBUS Tip Flow Monitor

Item	Part #	Description	Illustration
G	78-05105	Dual Tip Sensor Interface	
H	57-00122	Nozzle Flow Meter	
I	45-05856	Terminator, End (male)	
J	45-05855	Terminator, Start (female)	

Figure 2: System Diagram



## Boom Interface Module Harness Connection

With each machine having a different possible switchbox configuration, With each machine having a different possible switchbox configuration, the location to T-Tap into the valve harness cannot be specified.. However, the following guidelines may provide some assistance in completing the installation.

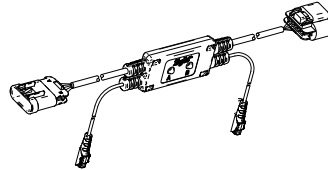
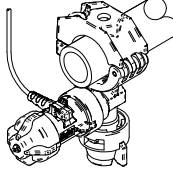
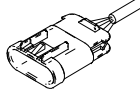
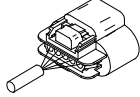
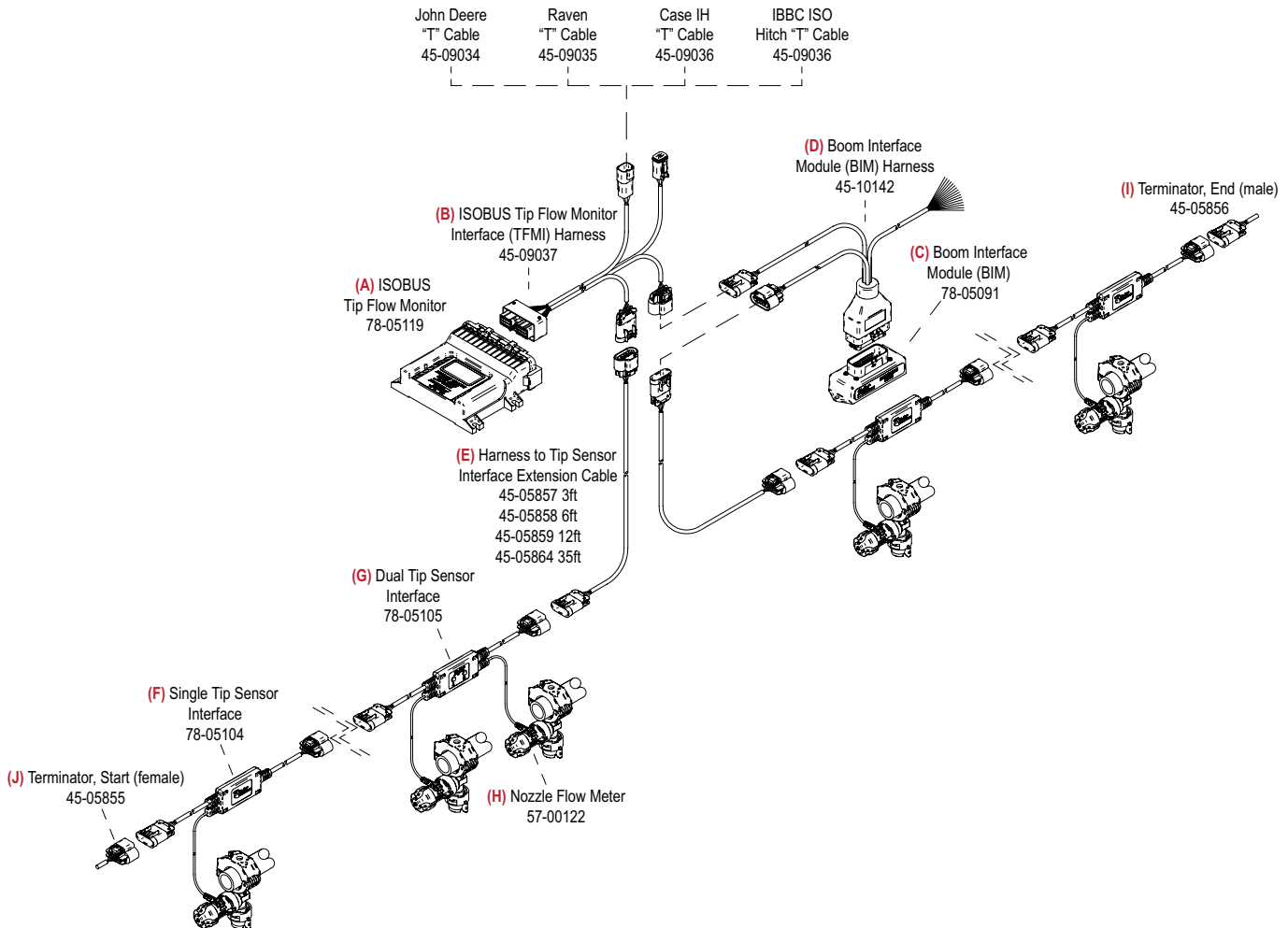
1. Identify boom section cable that runs from the Boom Switchbox to the boom valves.
2. Use a T-Tap (or similar product) to connect into the signal wire.

*NOTE: In some cases, the Boom Interface Module Harness wires can be connected directly to the switches inside the Switchbox using the proper spade terminal.*

3. Repeat this process for each individual boom section.

Figure 3: Boom Interface Module Harness Connection

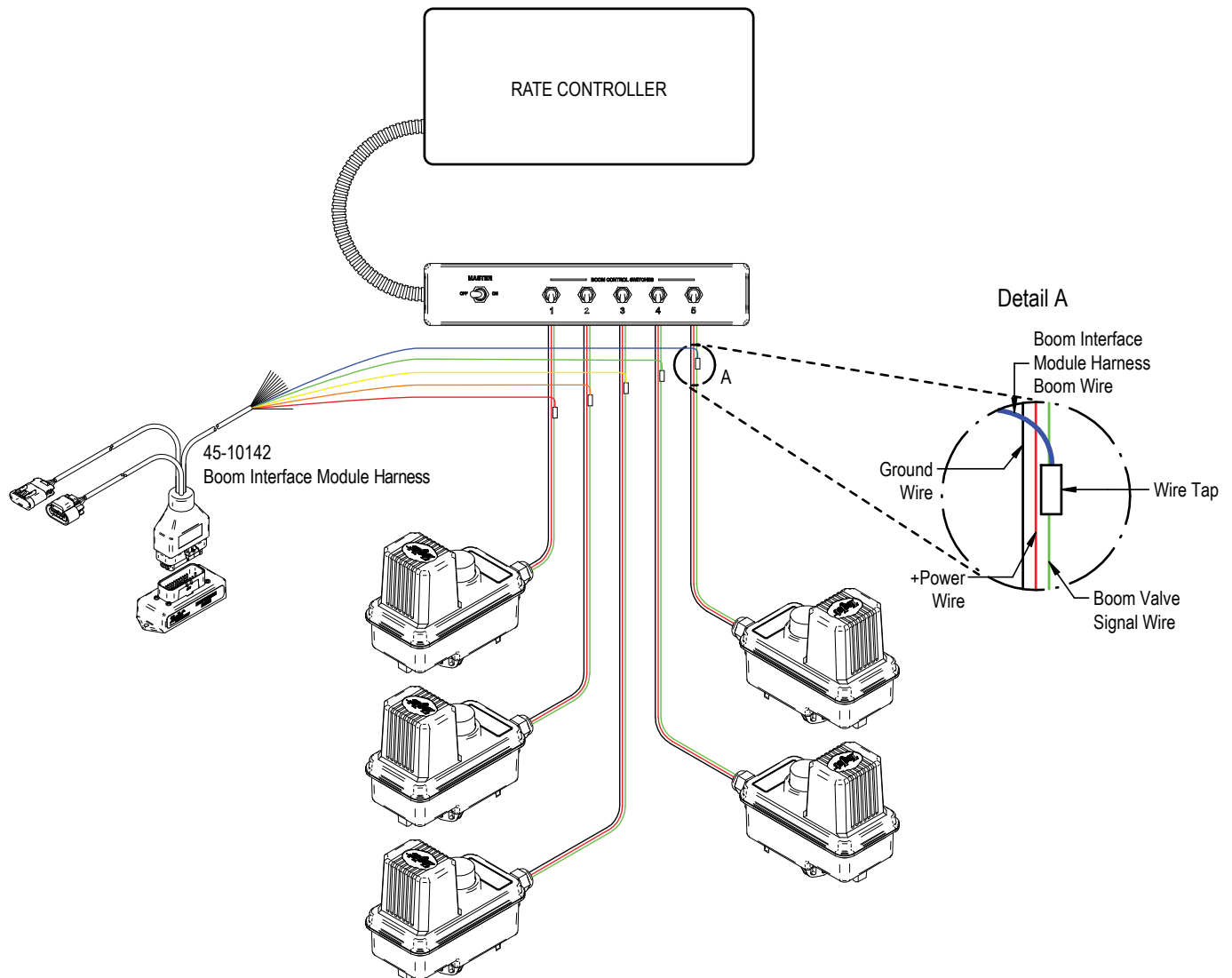

# Sentry 6141 ISOBUS Tip Flow Monitor

## INSTALLATION



If there are questions concerning the installation of the Sentry 6141 ISOBUS Tip Flow Monitor system on this vehicle, or due to the changes in component specifications the parts supplied in the kit are not exactly as presented in this document, please contact your dealer or TeeJet Customer service representative for clarification before installation. TeeJet Technologies is not responsible for misuse or incorrect installation of the system.

## NOZZLE BODY WITH FLOW METER AND TIP SENSOR INTERFACE

The turbine style flow meter used with the Sentry 6141 ISOBUS Tip Flow Monitor is compact, reliable and proven. The threaded connection allows the sensor to be added onto a wide range of standard TeeJet single and multiple outlet nozzle bodies. ChemSaver® diaphragm check valves remain in place allowing for positive spray tip shutoff. Ample clearance inside the flow meter means minimal flow restriction and generous free passage for particles contained in the spray solution. Long wearing materials are used in bearing surfaces to ensure a consistent flow reading and the flow meter sensor is mounted externally to prevent any direct contact with the spray solution for long-term reliability.

### Flow Meter Assembly

1. Remove end cap from nozzle body.
2. Attach end cap to flow meter (**H**).
  - ▶ The flow meter gasket has two different sides. The side with the larger center is to be inserted towards the sensor or inside the flow meter.
3. Attach flow meter to nozzle body. Hand tighten.
4. Loosely secure Tip Sensor Interface (**F or G**) close to nozzle body / flow meter assembly. Cable ties (not included) can be threaded through Tip Sensor Interface slots.
5. Push sensor of Tip Sensor Interface into slot on flow meter. Clips on flow meter should be in the grooves on the center of the sensor.
6. Secure Tip Sensor Interface.
7. Connect Start Terminator (**J**) to section 1 Tip Sensor Interface.
8. Connect each Tip Sensor Interface moving from left to right (while standing at the back of the machine).
  - ▶ Extension cables from Boom Interface Module Harness (**D**) and Tip Flow Monitor Interface Harness (**B**) will connect between two Tip Sensor Interfaces.
9. Connect End Terminator (**I**) to the last section's Tip Sensor Interface.

Figure 4: Flow Monitor Assembly

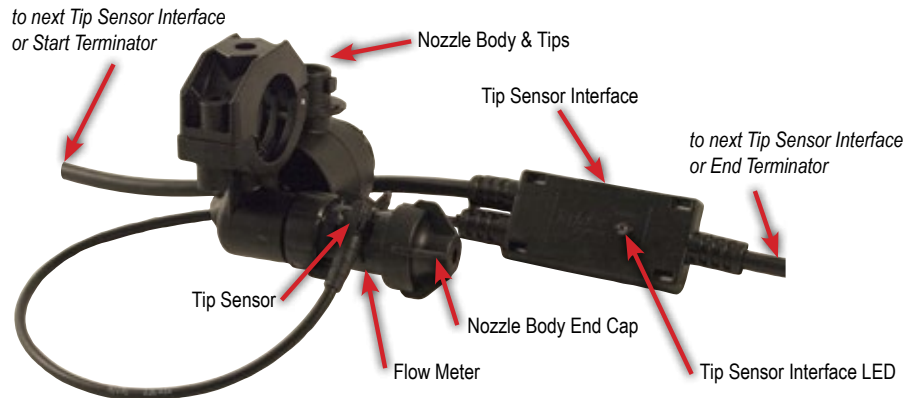

Figure 5: Flow Meter and Gasket Detail

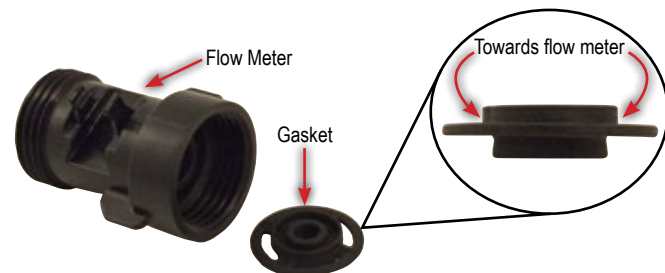
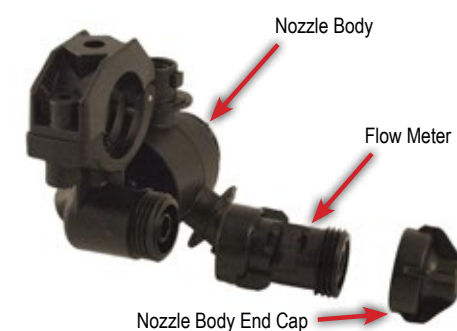

Figure 6: Nozzle Body with Flow Meter Assembly





# Sentry 6141 ISOBUS Tip Flow Monitor

Figure 7: Sensor & Clips

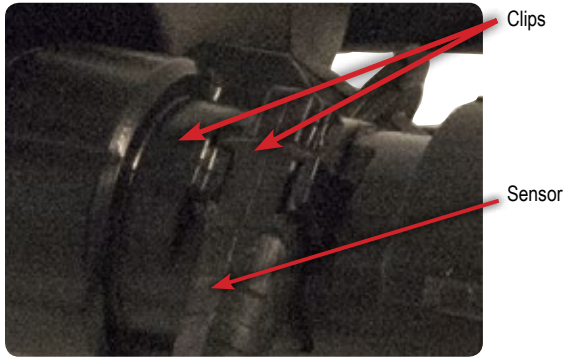
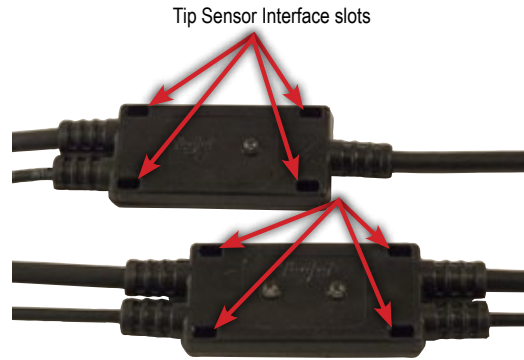

Figure 8: Tip Sensor Interface Slots



## POWER

On power up the ISOBUS Tip Flow Monitor (A) detects the number of Tip Sensor Interfaces (TSI) (F or G) located on each boom. The monitor then indicates the status of system components.

The Status Box displays if all tips are OK or if any errors are found.

During start up, LED's (see Figure 9) on each TSI turn on and turn off as each is detected and given a unique address. TSI unique addresses are assigned from left to right beginning at the Start Terminator.

- ▶ Sensor connected to the Start Terminator (female) (J) on the left side of the machine will be #1
- ▶ Sensor connected to the End Terminator (male) (I) on the right side of the machine will be the last sensor.

Figure 9: Tip Sensor Interface LEDs

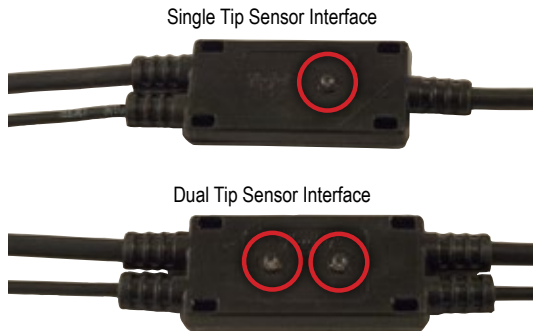
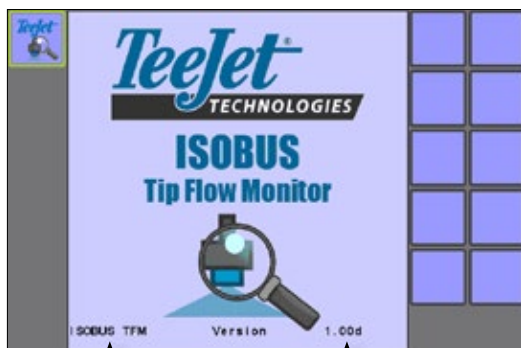

Figure 10: Splash Screen



Software

Software Version

## Home Screen

The errors that prevent the console from going into normal operation are now displayed on the Home Screen in a status box.

Figure 11: Home Screen

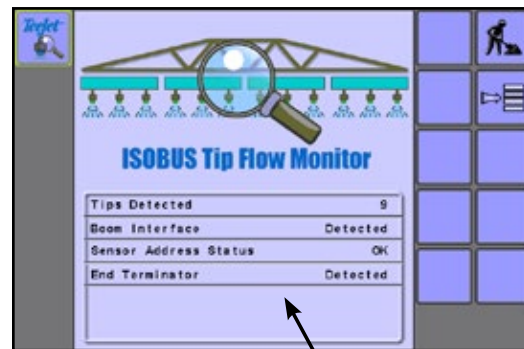

Status / Error Box

NOTE: Screen option may vary depending on enabled or disabled functions as well as function availability.

# Sentry 6141 ISOBUS Tip Flow Monitor

## MAIN SETUP MODE

If there are questions concerning the set up of Sentry 6141 ISOBUS Tip Flow Monitor, please contact your dealer or TeeJet customer service representative for clarification before operation. TeeJet Technologies is not responsible for misuse or incorrect operation of the system.

The main setup menu contains three options. Each of these options either directly access settings or additional menus.

Figure 12: Main Setup Screen

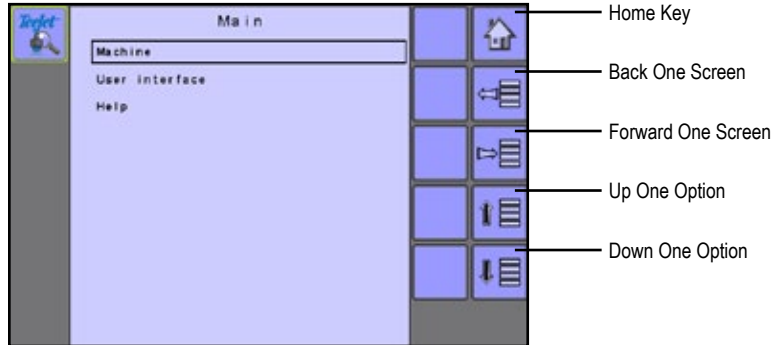

## MENU STRUCTURE

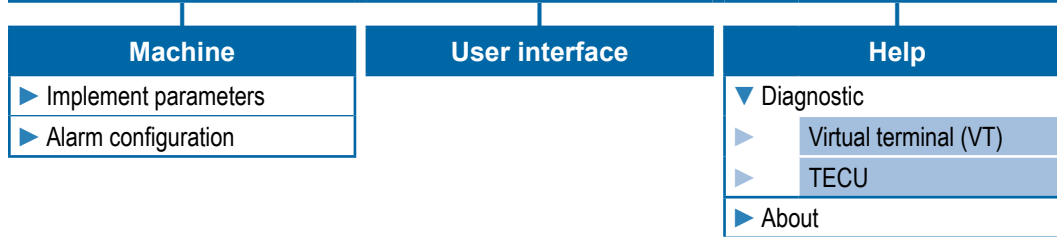

## MACHINE

Machine configures machine settings. Options include, Implement Parameters and Alarm Configurations.

1. From the Main Setup Screen , select MACHINE.
2. Select from:
  - ▶ Implement Parameters – establishes Tip Balance Allowance, Number of Boom Sections, and Number of Tips Per Section
  - ▶ Alarm Configurations – establishes alarm parameters

### Implement Parameters

Figure 13: Implement Parameters

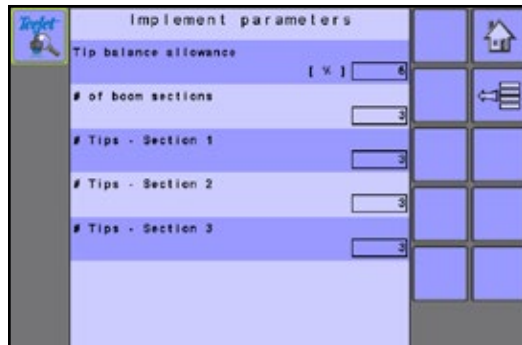

#### Number of Boom Sections

Enter the number of boom sections. The sections are numbered from left to right while standing in the forward facing direction of the machine and begin at the Start Terminator. Range is 1-15 sections.

#### Number of Tips per Section

Enter the number of tips on each boom section. Sections are numbered from left to right while standing in the forward facing direction of the machine and begin at the Start Terminator. Range is 1-120 tips.

#### Tip Balance Allowance

The tip balance allowance is the maximum flow deviation each tip is allowed from the boom average, without an alarm being triggered.

## Alarm Configurations

Figure 14: Alarm Configurations

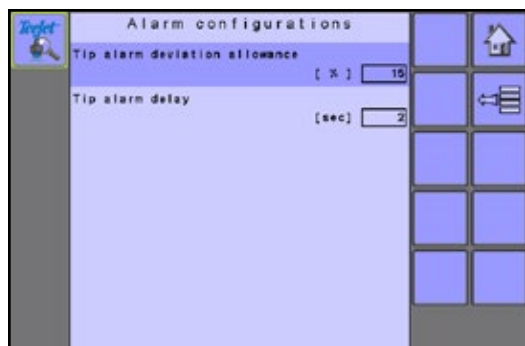

### Tip Alarm Deviation Allowance

 Sets the error reporting range for the tip sensors. If the flow rate of an individual tip falls below, or rises above this range, the console will generate an alarm. The value entered is the percentage above and below the average flow that a tip must exceed to trigger an alarm.

### Tip Alarm Delay

 Sets a time delay for the console to wait after an error has been encountered before sounding a tip alarm. If the error is corrected within this time, no alarm will sound or error will display on screen. Range is 1-10 seconds.

## USER INTERFACE

User Interface allows the operator to select the system universal terminal (UT) [referenced on screen as a virtual terminal (VT)].

1. From the Main Setup Screen , select USER INTERFACE.

Figure 15: User Preferred VT

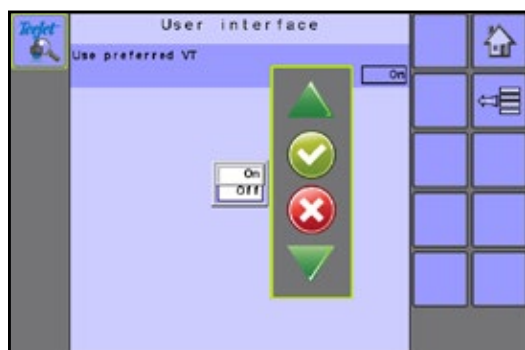

### User Preferred VT

Use Preferred VT sets the universal terminal preference to either on or off. If "On" is selected, the preferred UT will be used. If "Off" is selected, the system will arbitrarily select which UT to use (if more than one UT is available on the ISOBUS CAN).

*NOTE: This should always be set to "off" unless another UT is on the CAN bus.*

## HELP

The Help menu allows the operator to choose between Diagnostics and the display of information about serial number, CAN BUS information, etc. These menus are typically accessed upon Customer Service personnel request only.

1. From the Main Setup Screen , select HELP.
2. Select from:
  - ▶ Diagnostic – used to troubleshoot input/output of the controller (sensor or actuator).
  - ▶ About – provides information on the console such as software version, build number, etc.



*NOTE: Settings are NOT automatically saved when selected. The ACCEPT KEY  must be selected to save the setting. Select the ESCAPE KEY  to escape without saving settings and return to the previous menu.*

Figure 16: Help



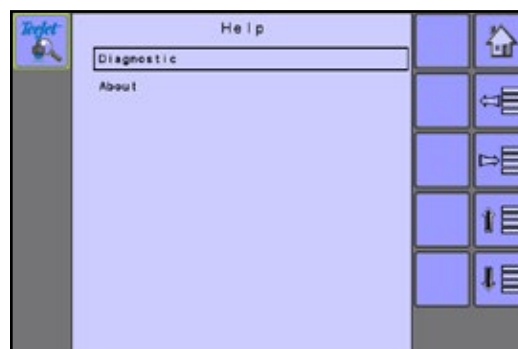

## Diagnostic

Troubleshoots input/output of the controller (sensor or actuator).

## VT Data

The Universal Terminal (UT) [formally known as Virtual Terminal (VT)] menu provides information regarding the virtual terminal controller (i.e., address version, etc.).

- If more than one UT is on the bus, switch between these by pressing the GO TO NEXT VT KEY .
- Press the DELETE OBJECT POOL KEY  to delete saved information on the UT. This forces the UT to upload all information from the ISOBUS Tip Flow Monitor on the next power cycle.

# Sentry 6141 ISOBUS Tip Flow Monitor

Figure 17: VT Data

VT Data	
Address VT:	30
ECU:	137
Part 6 version:	2
Status:	0
Softkey size X:	72
Y:	72
Virtual no:	54
Physical no:	10
Font Small:	54
Large:	1
Attributes:	54
Colour:	2
HW:	1
Data mask size:	480
	480

## TECU

The TECU is a control unit, residing on the tractor, that performs basic functions such as power handling, speed info, etc. The TECU data are displayed on this page.

Figure 18: TECU

TECU Data	
Ground based:	
Speed	11.3
Distance	1460
Direction	1
Wheel based:	
Speed	No data
Distance	No data
Direction	No data
Rear PTO:	
Actual Speed	No data
Local:	
Speed	No data
Distance	No data
Direction	No data

## About

The About screen provides information on the ISOBUS Tip Flow Monitor such as software version, build number, etc. This information may become useful in case of technical support.

Figure 19: About

About	
Software version	1.00
ECU board S/N	78051199999
ECU Board type/version	Type/Version
I/O board	Not detected
BUS ID	
PLP:	0 180: 1000648
180 11793, OEM name	TeeJet Technologies
180 11793, Man. code	108

## OPERATION

In Operation Mode, the system will monitor all the tips and their the flow rate if their respective boom section is turned on. The flow rate of each tip must be within the percentage range (entered in the Setup mode) of the boom's average. The LED on the Tip Sensor Interface (**H or I**) will also be illuminated corresponding to the tip or tips that are at fault.

## TIP BALANCE

Balancing the tips is required for the system to compare and monitor individual tips. The system will scan all the tips to get the flow rate. The flow rate of each tip must be within the tip balance percentage range of the average flow rate in order to balance successfully. If any tip is outside this range, an error will be generated, and the user will need to inspect the tip or flow meter for obstructions.

*NOTE: In order to maintain system accuracy, balancing the tips is required anytime a tip is changed. The console will not be able to detect small flow changes until a tip balancing is completed successfully.*

Figure 20: Tip Balance

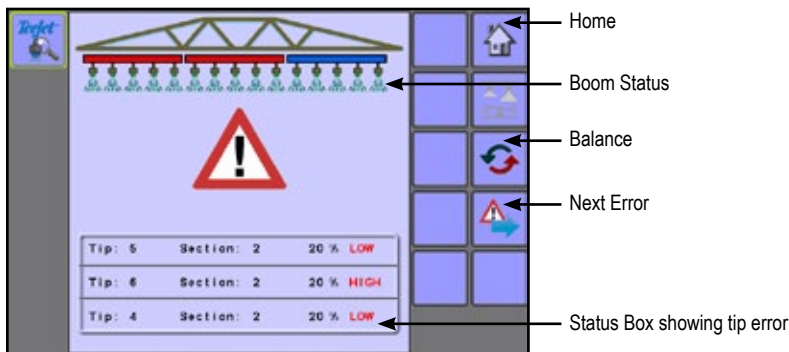
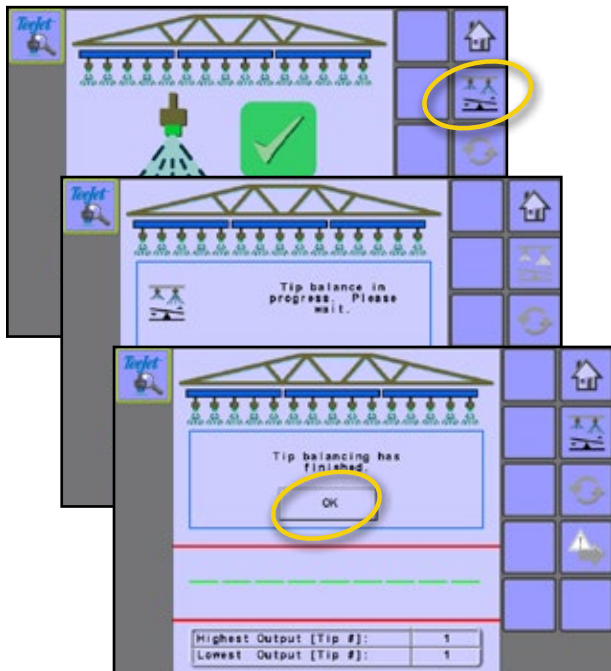





Figure 21: Tip Balance Process



### Initiating The Balancing Procedure

1. All boom sections must be on.
2. Press Work Button  on Home Screen.
3. Press BALANCE button  to start the balance check, a message box will appear.
4. If an error occurs, the alarm error chart appears with details. Inspect the tip(s) noted on the Status Box. The LED on the Tip Sensor Interface (**H or I**) will also be illuminated corresponding to the tip or tips that are at fault.



The NEXT ERROR button  is only enabled if more than three errors are found when balancing the tips.

5. After correcting the problem, press BALANCE button  to start new balance check.

# Sentry 6141 ISOBUS Tip Flow Monitor

## On Screen Indicators

### Boom Sections

- ▶ Blue Bar, Blue Spray – turned on 
- ▶ Red Tip, No Spray - turned off, empty, no spray 
- ▶ Red Bar, Blue Spray – a tip on that section has an error and needs to be inspected 

### Status Box

- ▶ Green Check Mark – shows all tips are operating normally
- ▶ Hazard Icon – an error occurred.
  - Tip Error – the Status Box will show the tip number(s) that is at fault with the percentage off.
  - System Error – the status box will show an error code

### Tip Flow Indicator

- ▶ Dashed Green Line – the average output of the entire boom.
- ▶ Solid Red Line – the tip alarm error reporting range.
- ▶ Blue Bar – variation from the boom's average. If it reaches the red line, an alarm will sound.

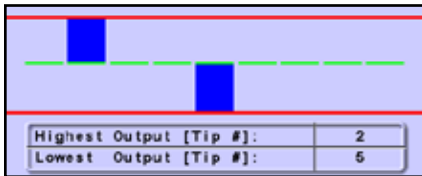

### Buttons



- ▶ Reset Error  – inactive unless an error occurs. It is then enabled to run the system again after checking the tips.
- ▶ Next Error  – only enabled if more than three errors are found when operating. It allows the user to cycle through the list of tips that need to be checked.
- ▶ Tip Balance  – press this button to balance tips.

Figure 22: Operation – All Tips OK

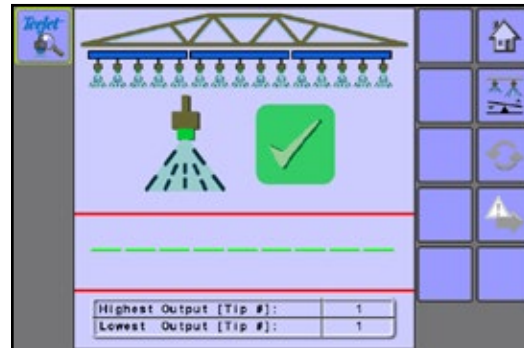
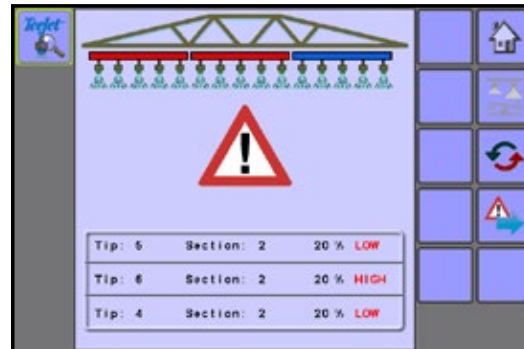

Figure 23: Operation – Tip Error





# SENTRY 6141

## USER MANUAL

---

### Identifying Plugged Spray Tips Has Never Been Easier

Worn, plugged or partially blocked spray tips can have a significant impact on the quality of your spraying job. Streaks in the field caused by misapplication can result in yield reductions, increased weed pressure and the need to re-apply – all of which can be costly. The Sentry 6141 Tip Flow Monitor provides a simple, reliable solution to this age-old problem. Flow sensors, mounted at each spray tip location, precisely measure the flow passing through the tip and provide instantaneous feedback to the operator should a tip become clogged, lost, or a nozzle body unintentionally rotated to an incorrect position. By eliminating the need to detect plugged tips visually from the cab, operators can cover more acres in a day, and know, with confidence, that their spray tips are operating properly.



[www.teejet.com](http://www.teejet.com)

A Subsidiary of  **Spraying Systems Co.**

98-05343-ENUS-LT R0 English-US  
© TeeJet Technologies 2016