



User Guide

TeeJet[®]



98-05054



USER GUIDE

Software Version 1.07

98-05054

R3



CenterLine

Software Version 1.07

Copyrights

© 2002 Midwest Technologies Illinois, LLC. All rights reserved. No part of this document or the computer programs described in it may be reproduced, copied, photocopied, translated or reduced in any form or by any means, electronic or machine readable, recording or otherwise, without prior written consent from Midwest Technologies.

Trademarks

Unless otherwise noted, all other brand or product names are trademarks or registered trademarks of their respective companies or organizations.

Limitation of Liability

MIDWEST TECHNOLOGIES ILLINOIS, LLC PROVIDES THIS MATERIAL "AS IS" WITHOUT WARRANTY OF ANY KIND, EITHER EXPRESSED OR IMPLIED. NO COPYRIGHT LIABILITY OR PATENT IS ASSUMED. IN NO EVENT SHALL MIDWEST TECHNOLOGIES BE LIABLE FOR ANY LOSS OF BUSINESS, LOSS OF PROFIT, LOSS OF USE OR DATA, INTERRUPTION OF BUSINESS, OR FOR INDIRECT, SPECIAL, INCIDENTAL, OR CONSEQUENTIAL DAMAGES OF ANY KIND, EVEN IF MIDWEST TECHNOLOGIES HAS BEEN ADVISED OF SUCH DAMAGES ARISING FROM TEEJET SOFTWARE.

Table of Contents

Introduction.....	2
About CenterLine	2
What's new in Version 1.07	3
About this User's Guide	4
Wireless Remote Control.....	6
CenterLine Lightbar.....	7
CenterLine Quick Start-up.....	8
General Start-up Sequence.....	8
First Time Start-up Sequence	8
CenterLine Product Kits.....	9
CenterLine Kit without DGPS Receiver.....	9
CenterLine Kit with RX 360p WAAS DGPS Receiver	10
CenterLine Kit with RX 350p WAAS DGPS Receiver	11
CenterLine with RX 400p DGPS Receiver	12
CenterLine Setup.....	13
Guidance Setup.....	14
Lightbar Setup.....	21
System Setup.....	26
CenterLine Setup Flow Diagram	28
Tools.....	29
Receiver	30
Lightbar.....	30
e-Dif	30
e-Dif Info	31
Demo.....	31
Next.....	31
To Start	31
CenterLine Real-Time Operation.....	32
Starting Real-time Operation	32
Real-time Operation.....	33
Real-time Menu	33
Return to Point	36
Exiting Real-time Operation.....	36
Headland Guidance Operation.....	37
Straight-line Guidance Operation	43
Curve AB Guidance Operation.....	45
Applied Area Detection	47
Lightbar Index.....	49

CenterLine

Software Version 1.07



CenterLine

A lightbar guidance system with wireless remote control.

Software Version 1.07

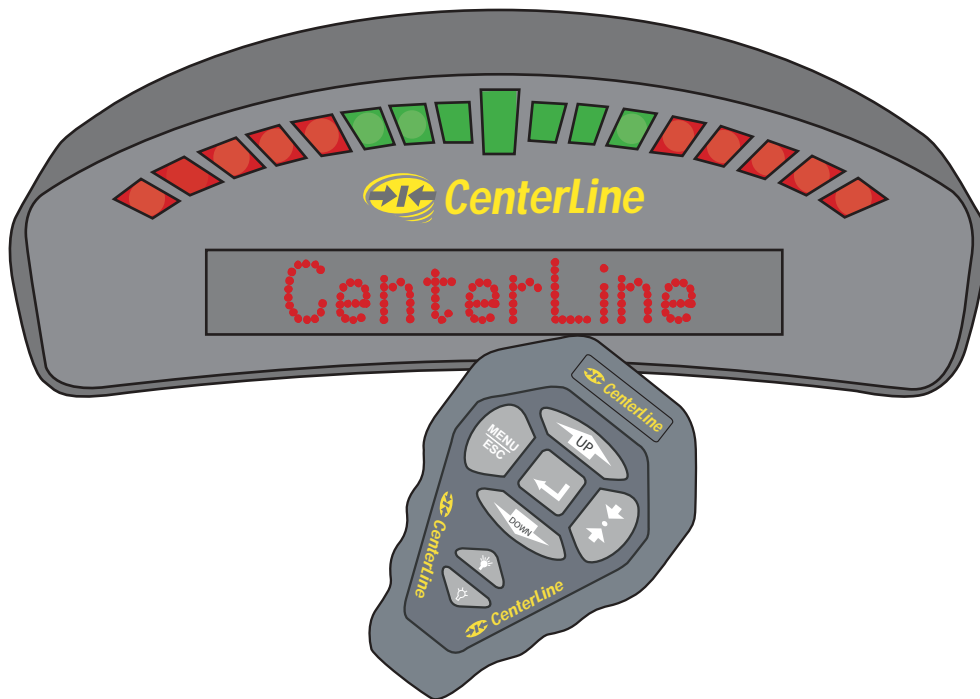

Introduction

About CenterLine

CenterLine is a low-cost lightbar guidance system, controlled by a wireless remote. CenterLine provides accurate straight-line and curved guidance, for use in spraying, seeding, and other related jobs at a cost that rivals foam markers. The CenterLine product comes with a combination Beacon/WAAS or WAAS only DGPS receiver, providing sub-meter, pass to pass, positioning accuracy. The wireless remote control is used to set-up and operate the system through menus and options displayed on the lightbar.

CenterLine's attractive design combines a compact size with easy to see LEDs that are fully adjustable. Using dedicated buttons on the wireless remote, the lightbar can be dimmed to efficiently run at night and brightened to be easily seen in full sunlight.

Straight or Curved Guidance

CenterLine guides along swaths of all kinds with sub-meter, pass to pass, accuracy. Select the driving pattern and CenterLine determines the closest swath to follow. There's no need to decide a guidance pattern ahead of time, or to commit to a pattern for the entire job. Centerline allows the switching of patterns in real-time, determining when a new pattern is being used and keeping the operator informed of the current status.

Wireless Remote Control Unit

CenterLine's ergonomic, handheld, remote control is easier to use than most TV remotes. Seven easy to read keys allow the scrolling of menus displayed on the lightbar. The remote keypad is backlit for night-time operation, and 3 AAA batteries (included) powers the unit for an entire season.

The small, powerful, remote permits mounting the weather-resistant lightbar outside on the hood or in the cab. When mounted outside, wireless communication permits easy operation while the cab stays clean and sealed from dust and contaminants.

Lightbar Shows you the Information You Want

A text display on the lightbar reports a choice of guidance information. It also warns when an area of the field is entered that has already been applied. Guidance text information can be turned off, if preferred. Choose two of these guidance messages to monitor progress in real-time:

- Cross-Track Error,
- Current Swath Number,
- Vehicle Speed,
- Applied Area,
- Vehicle course on the ground.

What's new in Version 1.07

- The new "Curve AB" guidance mode allows parallel guidance, similar to "Straight" and "Headland" guidance, along curved guide lines (See "Curve AB Guidance Operation" on page 45).
- The current (selected) guidance mode is displayed in reverse video and without a "?" in the Real-Time menu, to remove the confusion about which guidance mode is active. (See "Real-time Operation" on page 33).
- The new "GPS Only" mode allows the use of a GPS receiver without differential correction. (See "GPS Type" on page 19).
- Lightbar text messages, formerly available only in Straight guidance mode, is now also available in Headland and Curved AB modes. (See "Text 1 and Text 2" on page 22).
- A "Demo" mode is now included, primarily for use by sales personnel to demonstrate the capabilities of the CenterLine system. (See "Demo" on page 31).
- Additional languages are now available. (See "Language" on page 27).
- A new diagnostic tool is included for testing e-Dif GPS receivers. (See "e-Dif Info" on page 31).

About this User's Guide

This is revision 3 of the CenterLine user's guide and covers CenterLine software versions 1.07 to 1.99. Some software versions may come with a supplement to this user's guide.

Menu Items and Pick List Text

Throughout this user's guide, menu item text is displayed between the <> characters. For example, <START>. Keys on the remote (See Figure 4 on page 6) are denoted in bold italics, such as *Enter*.

Most of the figures in this user's guide are of menu items that are displayed in the text window of the lightbar (See Figure 5 on page 7). This text represents either a menu item, such as <GUIDANCE> or a pick-list item, such as <METRIC>. The lightbar text window can display a single line of text up to ten characters long. Figure 1 shows an example of a single text line that would be displayed on the lightbar.



Figure 1: Example of Text Displayed on Lightbar

Figures with multiple menu items are depicting the menu items that are above, below, left, and right of the text line currently in view. Figure 2 shows several menu items. The current menu item in view is <SETUP> and is denoted with a black arrow to the right side of the text. This figure is showing that the *Up* and *Down* arrow keys can be used to scroll between <START>, <SETUP>, and <TOOLS>. If the *Enter* key on the remote is pressed, the display moves to the <GUIDANCE> setup menu item. This figure also shows that, from the <GUIDANCE> menu item, it is possible to scroll between the <GUIDANCE>, <LIGHTBAR>, and <SYSTEM> setup menus using the *Up* and *Down* arrow keys.

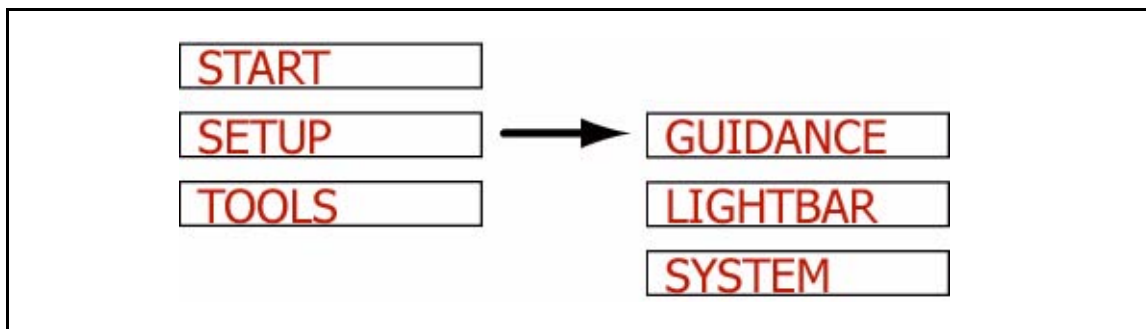

Figure 2: Displaying Multiple Text Lines

Menu Items Next and To Start

There are two additional menu items that are found in almost every menu; <NEXT> and <TO START>. Figure 3 shows the <NEXT> and <TO START> menu items in the System Setup menu list. Pressing **Enter** at <NEXT> brings up the next menu heading. As an example, pressing **Enter** at <NEXT>, while in Lightbar setup, brings up <SYSTEM>. In the same example, pressing **ESC** at <NEXT> brings up the <LIGHTBAR> menu item. Selecting <TO START> automatically goes back to the <START> menu. From here real-time guidance can be started. Using <TO START> is useful when it is necessary to quickly change one setting and then go right back into real-time operation.

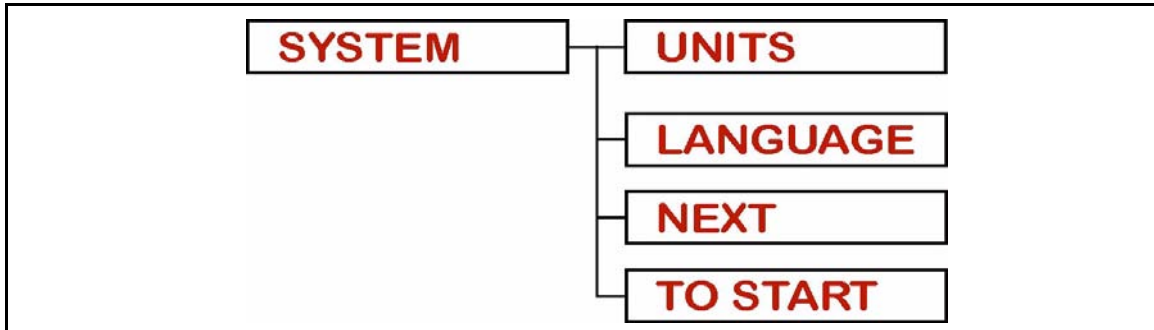

Figure 3: Next and To Start Menu Items

Software Components

CenterLine software can be broken into three components: Setup (See “CenterLine Setup” on page 13), Real-Time (See “CenterLine Real-Time Operation” on page 32), and Tools (See “Tools” on page 29). Setup allows the configuring of the CenterLine to best suit the current needs, and the Real-Time component handles all of the real-time guidance operations. The Tools component provides basic diagnostics for the lightbar and the attached GPS receiver.

Wireless Remote Control

General Operation

Operation of CenterLine software is via remote keypad input and menu items displayed in the text display area (See Figure 5) of the CenterLine lightbar. The **Up** and **Down** arrow keys are used to scroll through menus, sub-menus, and pick lists. The **Enter** key is used to enter menus and sub-menus, and accept a desired pick-list entry. The **ESC** key acts as cancel.

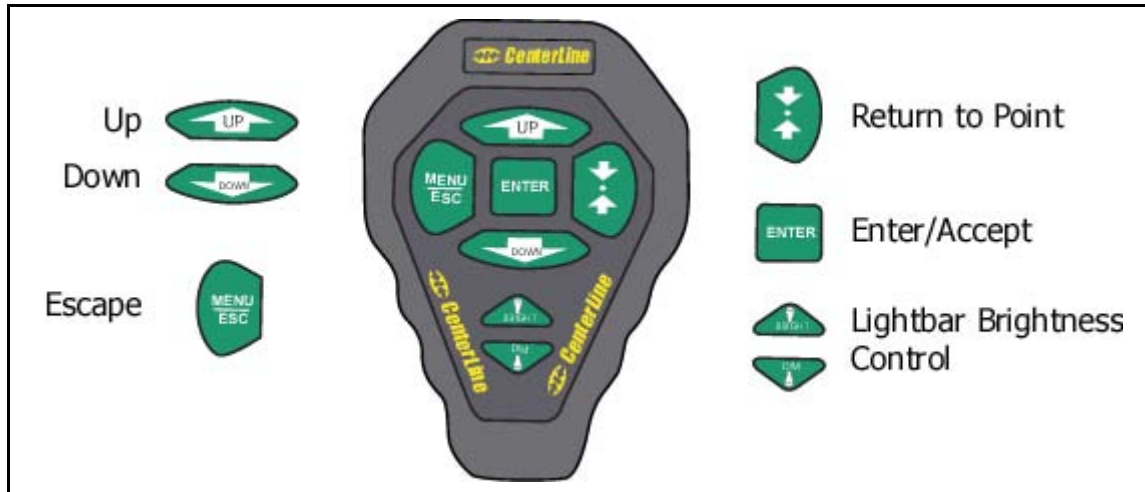

Figure 4: The Wireless Remote Control Unit

FCC Statement

This device complies with part 15 of the FCC Rules. Operation is subject to the following two conditions: (1) This device may not cause harmful interference, and (2) this device must accept any interference received, including interference that may cause undesired operation.

QS7CL7850094

QS7CL7850107

TR19JN96.008

Changes or modifications to the product, not expressly approved by Midwest Technologies Illinois, LLC, could void the user's authority, as granted under Part 15 of the FCC Rules, to operate the equipment.

CenterLine Lightbar

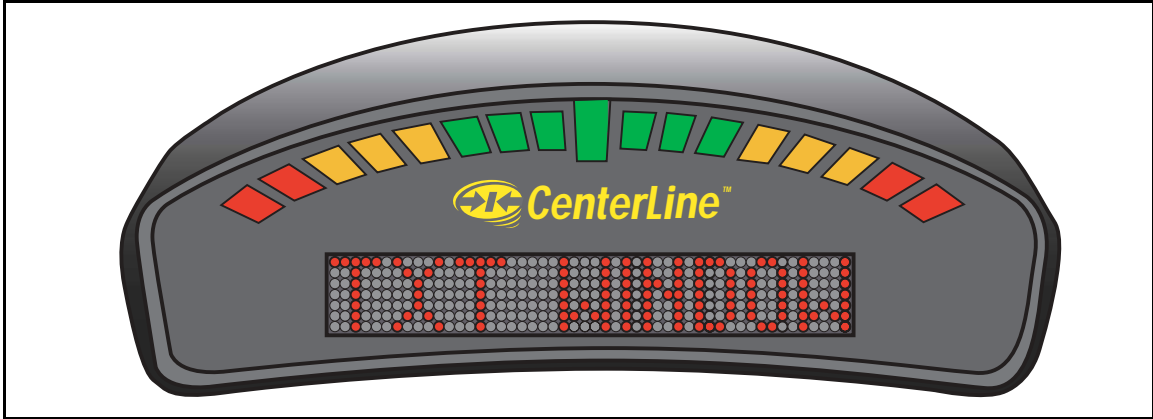

Figure 5: The CenterLine Lightbar

Lightbar Specifications

Housing Material:	ABS/Poly carbonate alloy construction.
Dimensions:	3.70"H x 9.40"W x 3.80"D (95 mm x 240 mm x 100 mm)
Weight:	0.8 lbs (0.36 kg)
Processor:	Intel StrongARM
MEMORY:	16 MB Ram, 2 MB Flash
LEDs:	High-lumen red, yellow, and green radial light pattern and 10 character LED alpha-numeric text display. Full brightness control adjustment using wireless remote.
Operating Temp:	32 to 160 F (0 to 70 C)
Storage Temp:	-40 to 185 F (-40 to 85 C)
I/O to DGPS:	1 asynchronous RS 232
I/O to Control Unit:	Wireless link operating at 433 MHz. FCC part 15 and Industry Canada RSS-210 certified. Other certifications pending.
Mounting:	Mounting bracket supplied. Magnetic and suction mounts are optional.

CenterLine Quick Start-up

The following section assumes that your CenterLine hardware has been properly set up. See “CenterLine Product Kits” on page 9 - 12 for information on how to configure the system.

General Start-up Sequence

- Apply power to CenterLine.
- Lightbar performs a start-up sequence.
- Lightbar displays current software version.
- Lightbar displays <START>.
- <START> display should remain until **Enter** is pressed to start real-time guidance or the Start menu is scrolled, using **Up** or **Down** to move to another menu option; <SETUP> or <TOOLS>.

First Time Start-up Sequence

- Apply power to CenterLine.
- Lightbar performs a start-up sequence.
- Lightbar displays current software version.
- Lightbar displays <START>.
- Using **Up** or **Down**, scroll until <SETUP> is displayed on the lightbar. Press **Enter**.
- Set up the CenterLine system by choosing the proper selections found in the three setup sub-menus <GUIDANCE>, <LIGHTBAR>, and <SYSTEM>. It is important to have the correct swath width entered.
- Return to the <START> location and press Enter to begin real-time guidance.

CenterLine Product Kits

CenterLine Kit without DGPS Receiver

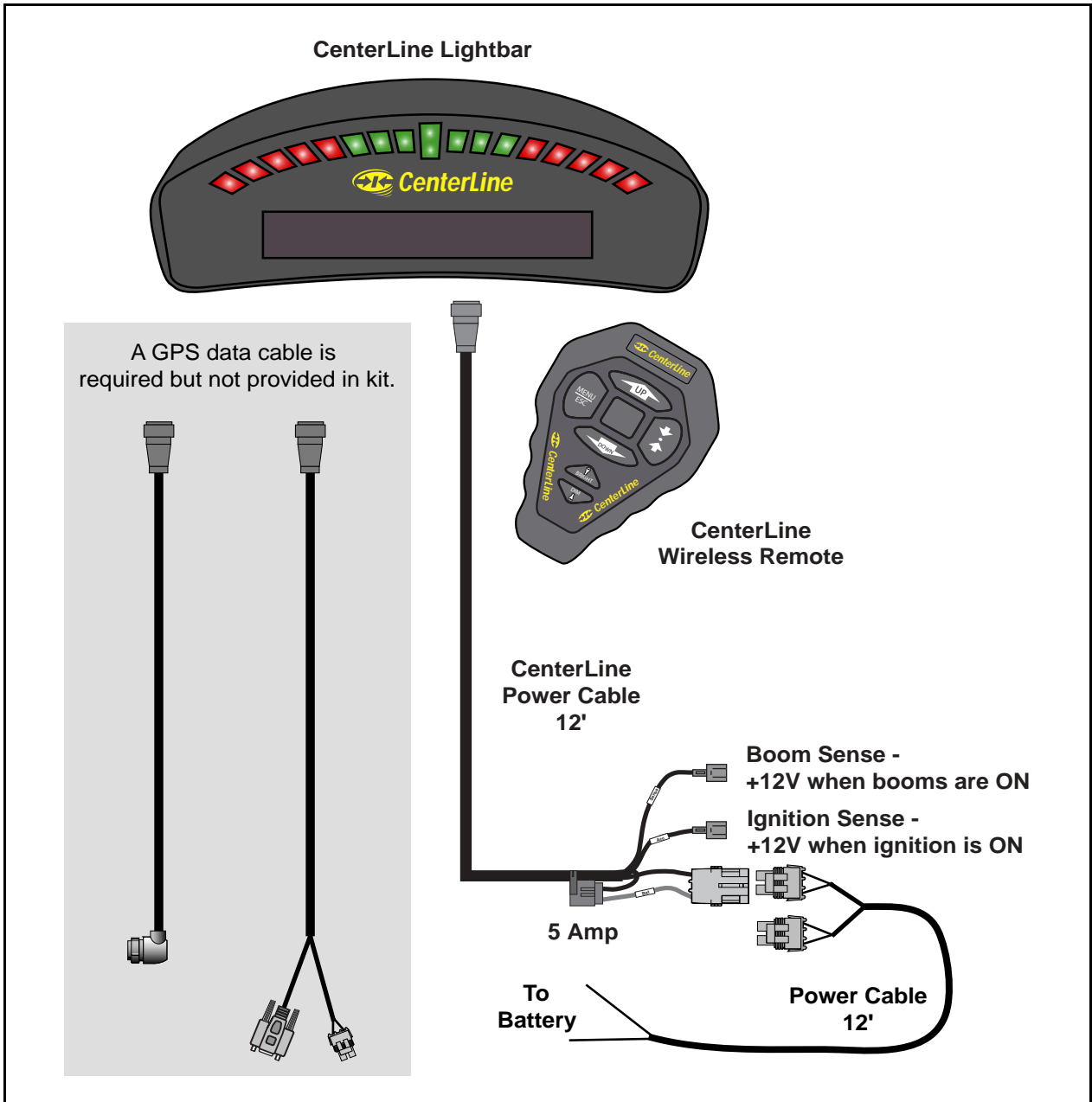

Figure 6: CenterLine without DGPS Receiver

CenterLine Kit with RX 360p WAAS DGPS Receiver

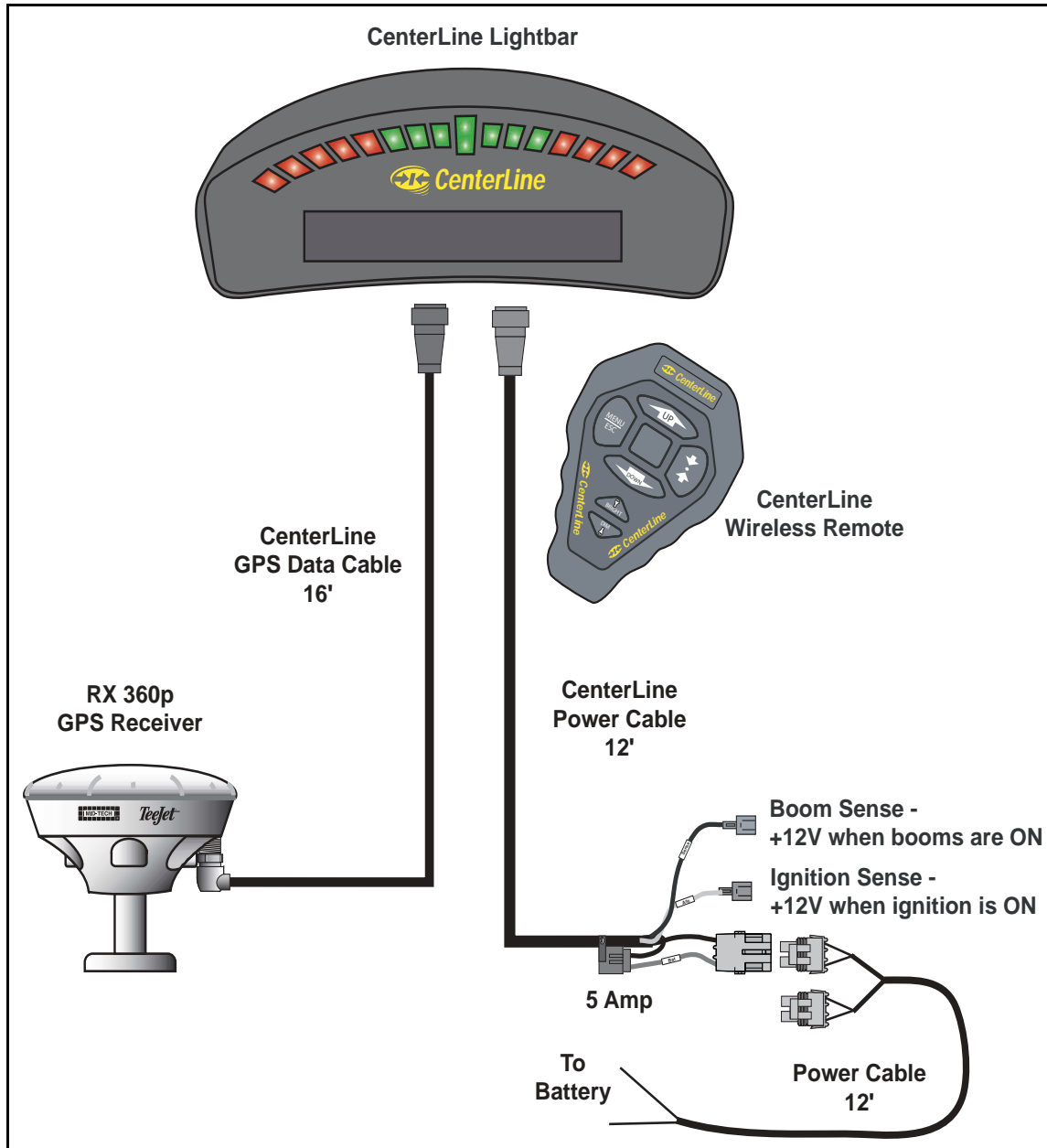

Figure 7: CenterLine Kit with RX360p WAAS DGPS Receiver

CenterLine Kit with RX 350p WAAS DGPS Receiver

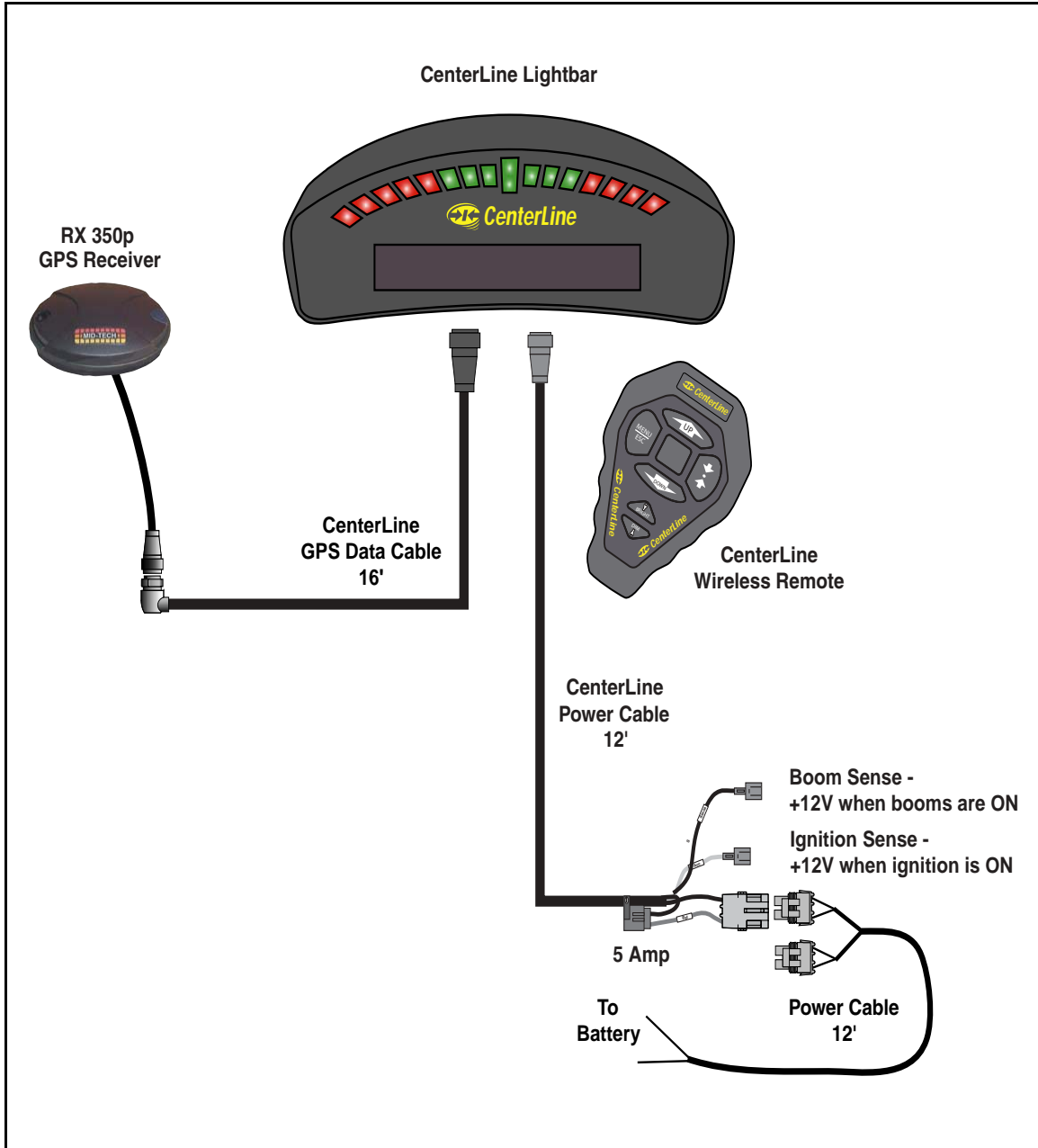

Figure 8: CenterLine with RX 350p WAAS DGPS Receiver

CenterLine Setup

CenterLine Setup allows the configuring of the CenterLine product to best suit the current guidance and mapping needs. For the complete overview of the Setup process see the "CenterLine Setup Flow Diagram," on page 28. CenterLine Setup has three sub-menus: <GUIDANCE>, <LIGHTBAR>, and <SYSTEM>. Each is described in detail below. Figure 10 shows the Setup flow.

The top level of CenterLine software has three menus to choose from: <START>, <SETUP>, and <TOOLS>. To enter the setup menus, use **Up** or **Down** to scroll until <SETUP> is visible and press **Enter**. When in Setup, scroll through the setup menu list, <GUIDANCE>, <LIGHTBAR>, and <SYSTEM>, and select the desired setup menu by pressing **Enter** (See Figure 10).

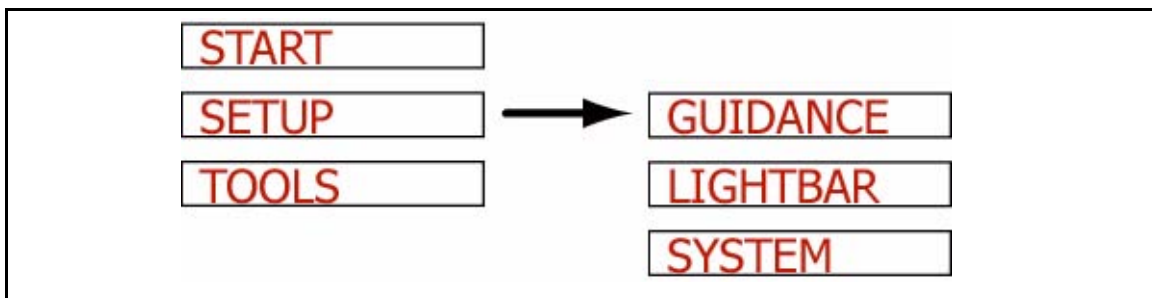

Figure 10: CenterLine Setup Flow

Guidance Setup

Guidance setup allows the setup of several parameters that pertain to guidance functionality. Currently there are four guidance settings (see Figure 11).

To access Guidance setup from the Setup menu, scroll until the text window displays <GUID-ANCE>, and press **Enter**. Menu item <WIDTH> should be displayed in the text window. Use **Up** or **Down** to scroll through the list of Guidance setup menu items.

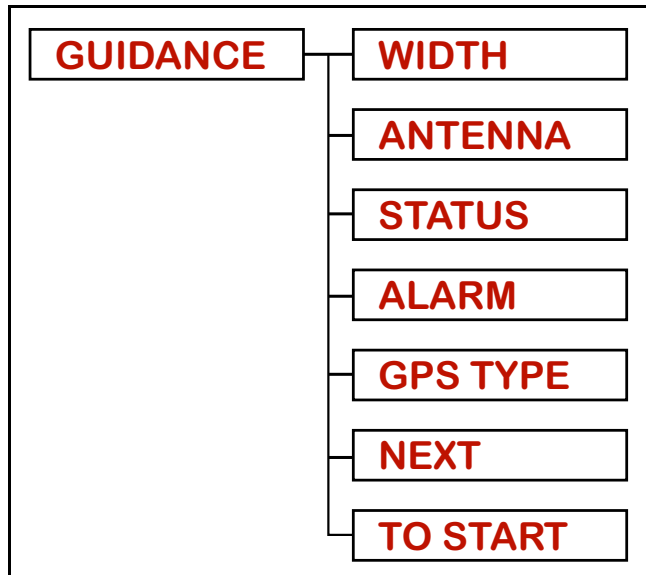

Figure 11: Guidance Setup Flow

Setting Name	Default Value	Change at 1st Time Start Up
Width	30.0 feet (10 meters)	Required
Antenna -Direction	None	Recommended
Antenna - Distance	0.0 ft.	Recommended
Status Detect	Off	Optional
Alarm	Off	Recommended
GPS Type	DGPS	Recommended

Table 1: Guidance Menu Item Default Settings

The Guidance menu item <ANTENNA> is a sub-menu of Guidance. The <DIRECTION> and <DISTANCE> menu items are listed under this Antenna sub-menu. The offset distance and direction (See Figure 16) can be set from these menu items.

CenterLine

Software Version 1.07

Width

The Guidance setup parameter Width is the distance between guidelines. This width is typically the vehicle implement width or spread width. Setting this width slightly smaller than the actual width reduces skips. Setting this width slightly larger than the actual width reduces overlap.

To adjust the Width setting, go to <GUIDANCE>, scroll with **Up** or **Down** until <WIDTH> is displayed, and press **Enter**. To increase the width press **Up**; to decrease the width press **Down**. Press **Enter** when the desired width is set. The width value increments in 0.1 ft. intervals.



Figure 12: Setting the Guidance Width Value

Antenna

The Antenna sub-menu defines the spatial relationship between the GPS antenna and the vehicle implement or delivery point. The GPS antenna should always be mounted along the vehicle center line (See Figure 16). The two Antenna menu settings are Direction and Distance.

To enter the Antenna sub-menu, go to <GUIDANCE>, scroll until <ANTENNA> is displayed in the text window, and press **Enter**. As mentioned, there are two settings under Antenna: <DIRECTION> and <DISTANCE>. The text window should display <DIRECTION>. Use **Up** or **Down** to move between the <DIRECTION> and <DISTANCE> settings. Press **Enter** when the desired setting is in the text window.

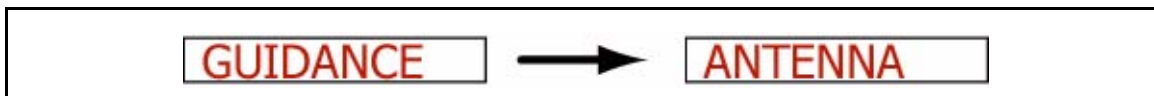

Figure 13: Accessing the Antenna Sub-Menu

Direction

The Direction setting is the direction from the GPS antenna to the swath or delivery point (See Figure 16).

To change the Direction setting, go to the Antenna sub-menu of Guidance setup, scroll until <DIRECTION> is displayed in the text window, and press **Enter**. Using **Up** or **Down** scroll through the direction pick list (See Figure 14) until the desired direction is displayed in the text window. Press **Enter** to save the setting and return to the Guidance setup menu.

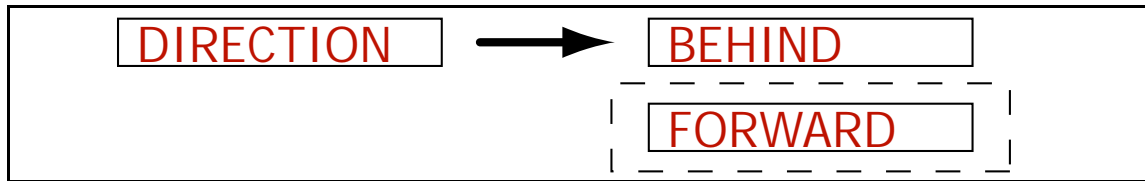

Figure 14: Setting the Direction to Swath

Setting	Description
Back	The swath or delivery point is behind the GPS receiver on the vehicle along the vehicle center line.
Forward	The swath or delivery point is in front of the GPS receiver on the vehicle along the vehicle center line.

Table 2: Direction to Swath Settings

Distance

The Distance setting is the distance from the GPS antenna to the swath or delivery location (See Figure 16).

To adjust the Distance setting, go to the Antenna sub-menu of Guidance setup and press **Enter**. Scroll until <DISTANCE> is displayed in the text window and press **Enter**. To increase the distance press **Up**; to decrease the distance press **Down**. Press **Enter** when the desired distance is displayed.



Figure 15: Setting the Distance to the Swath

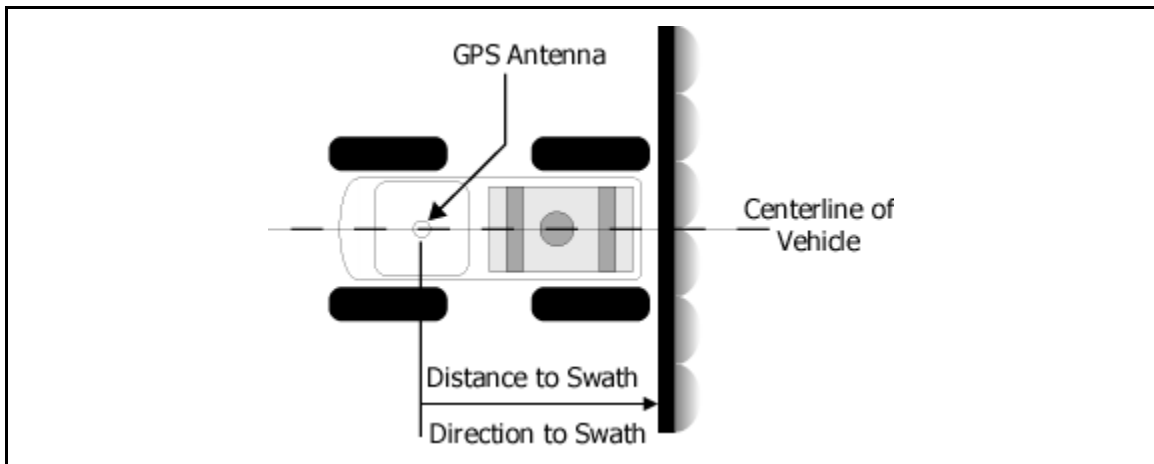

Figure 16: Direction and Distance to Swath from DGPS Receiver

Status

The <STATUS> setting is used to auto detect implement status. When the status detect is properly implemented, the CenterLine detects whether product delivery is on or off, based on the vehicles product on/off switch. See “CenterLine Product Kits” on page 9 - 12 for location of status connect (boom sense) wiring.

To adjust the Status setting, go to Guidance setup, scroll with **Up** or **Down** until <STATUS> is displayed in the text window, and press **Enter**. Using **Up** or **Down**, scroll between the <ON> and <OFF> settings until the desired setting is displayed in the text window. Press **Enter** to save the setting and return to the Guidance setup menu.

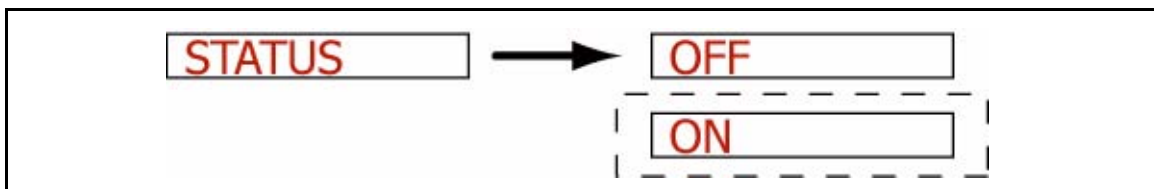

Figure 17: Selecting the Status Setting

Setting	Description
OFF	No Status Detect implemented. Default setting.
Table 3: Status Settings	
ON	Status detect assumes a single swath centered on the vehicle.

Alarm

The <ALARM> setting, when set to ON, notifies the operator when entering a previously applied area. The text window displays <APPLIED> when the implement swath is in a previously applied area of the field.

To adjust the Alarm setting, go to Guidance setup, scroll until <ALARM> is displayed in the text window, and press enter. Using **Up** or **Down**, scroll between the <ON> and <OFF> settings until the desired setting is displayed in the text window. Press **Enter** to save the setting and return to the Guidance setup menu.

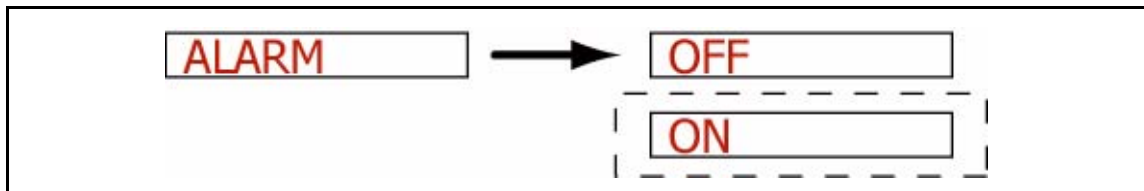

Figure 18: Setting the Alarm

Setting	Description
Off	No applied area detection.
On	Applied area detection alarm.

Table 4: Status Detect Settings

CenterLine

Software Version 1.07

GPS Type

GPS Type indicates to the CenterLine system whether the GPS receiver is differentially corrected or not.

To adjust the GPS Type, go to Guidance setup, scroll until <GPS TYPE> is displayed in the text window, and press enter. Using **Up** or **Down**, scroll between the <DGPS> and <GPS> settings until the desired setting is displayed in the text window. Press **Enter** to save the setting and return to the Guidance setup menu.

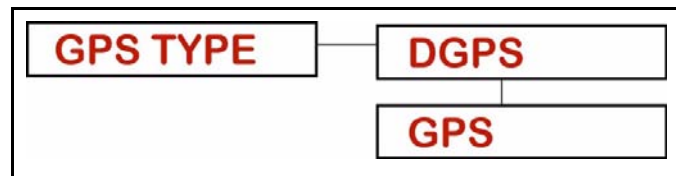

Figure 19: Selecting the GPS Type

Setting	Description
GPS	GPS receiver with no differential correction - capable of providing positioning accuracy of around 10 meters.
DGPS	GPS receiver with differential correction - capable of providing sub-meter positioning accuracy.

Table 5: GPS Types

1 Hz Msg

A 1 Hz data rate is not recommended for vehicle guidance, so a “GPS Slow” message is sent to the lightbar to notify the operator if the GPS receiver is set to a 1 Hz data rate. However, there are some areas where the 1 Hz rate is used. For those areas, we provide the ability to disable the “GPS Slow” message.

To turn the “GPS Slow” message on or off, go to Guidance setup, scroll until <1 Hz Msg> is displayed in the text window, and press enter. Using **Up** or **Down**, scroll between the <YES> and <NO> settings until the desired setting is displayed in the text window. Press **Enter** to save the setting and return to the Guidance setup menu.

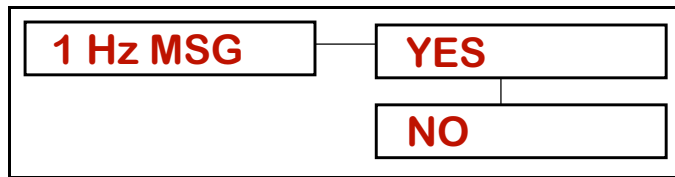

Figure 20: Selecting the GPS Type

Setting	Description
Yes	When the data rate of the GPS receiver is set to 1 Hz, a “GPS Slow” message is sent to the lightbar, and the guidance function is disabled.
No	When the data rate of the GPS receiver is set to 1 Hz, a “GPS Slow” message is sent to the lightbar when you first enter real-time operation, but guidance is allowed.

Table 6: 1 Hz Msg

Lightbar Setup

Lightbar setup allows the selection of several parameters related to the lightbar. There are five lightbar settings: Drive Sensitivity <SPACING>, Display Mode <MODE>, two selectable messages: <TEXT 1> and <TEXT 2>, and <STEER BAR?> (See Figure 21 and Table 7).

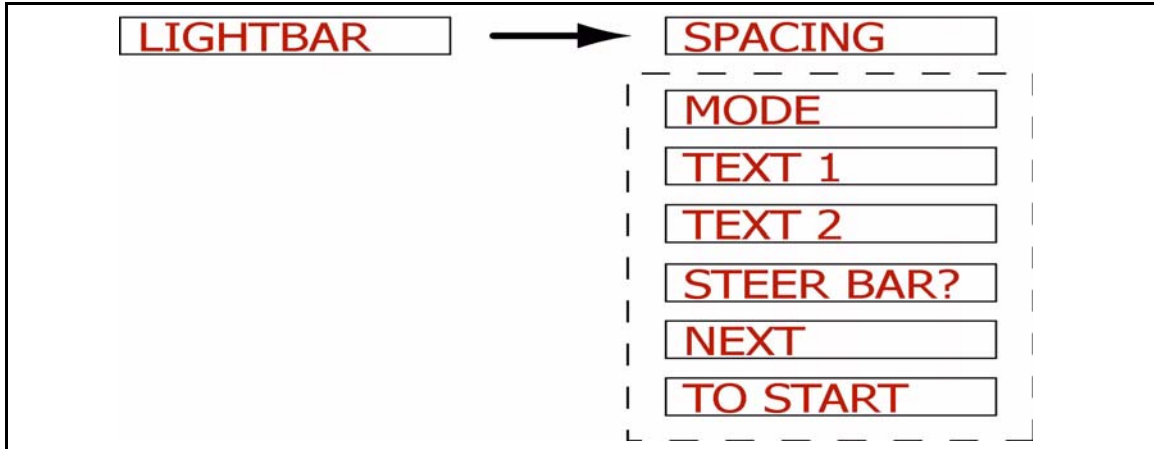

Figure 21: The Lightbar Setup Flow

Setting Name	Default Value	Change at 1st Time Start up
Spacing	1.5 ft.	Optional
Mode	Swath	Optional
Text 1	X-Track Error	Optional
Text 2	Applied Area	Optional
Steer bar?	No	Optional

Table 7: Lightbar Menu Item Default Settings

Spacing

The Spacing setting allows the selection of the distance that a single light on the lightbar LEDs represents.

To change the Spacing setting, go to Lightbar setup, scroll until <SPACING> is displayed in the text window, and press **Enter**. To increase the spacing distance press **UP**; to decrease the spacing press **Down**. Press the **Enter** key when the desired spacing is set. The Spacing range is 0.5 ft. to 9.5 ft., in 0.5' increments.

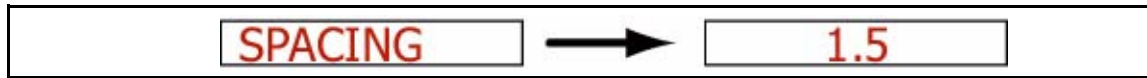

Figure 22: Setting the LED Spacing

Mode

The Mode setting defines how the row of LEDs are interpreted. The center stack of Green LEDs can represent either the current guideline or the vehicle (See Table 8).

To change the Mode setting, go to Lightbar setup, scroll until <MODE> is displayed in the text window, and press **Enter**. Using **Up** or **Down**, scroll through the Mode pick list until the desired setting is displayed in the text window. Press the **Enter** key to save the setting and return to the <TEXT 1> menu item.

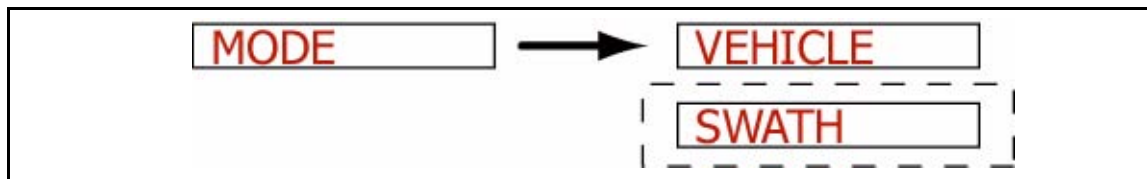

Figure 23: Setting the Mode

Setting	Description
Swath	When Display Mode is set to Swath, the center stack of Green LEDs represents the current guideline. In this mode, steer the vehicle to bring the moving LED back to center
Vehicle	When Display Mode is set to Vehicle, the center stack of Green LEDs represents the vehicle's position. In this mode, steer the vehicle to bring the center lights towards the moving LED.

Table 8: Display Mode Settings

Text 1 and Text 2

The Text 1 and Text 2 settings allow you to select text messages from a set of predetermined guidance information messages. These messages are displayed in the lightbar text window for 15 seconds when first enabled, and cycled through during guidance operations. A maximum of two text messages can be displayed.

CenterLine

Software Version 1.07

Text 1

To select the Text 1 setting, go to Lightbar setup, scroll using **Up** or **Down** until <TEXT 1> is displayed in the text window, and press **Enter**. Using **Up** or **Down** scroll through the Text 1 pick list until the desired message is displayed in the text window. Press **Enter** to save the setting and advance to the <TEXT 2> menu item.

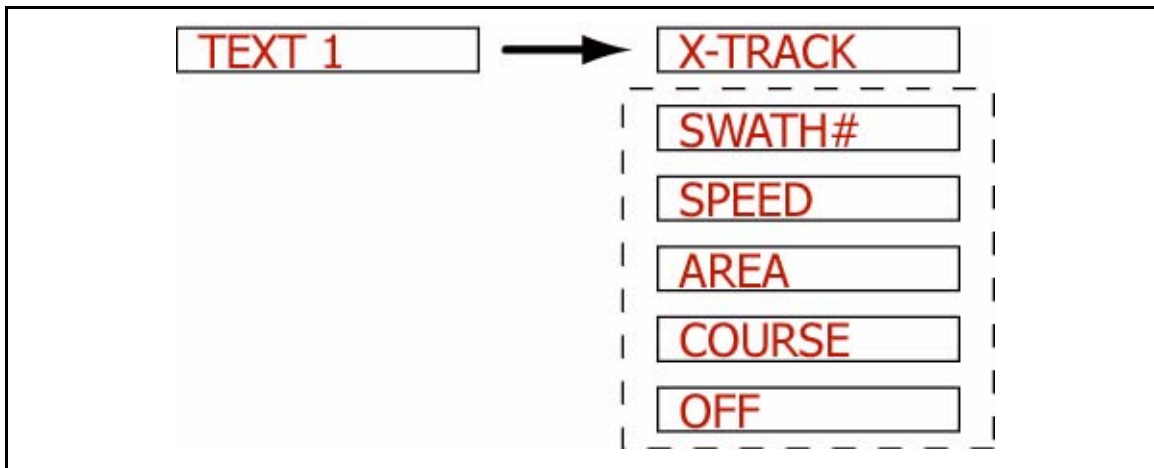

Figure 24: Selecting the Text 1 Message

Message	Description
X-Track	Displays the error (in distance) between the current guideline and the vehicle position.
Swath #	Displays the current guideline number.
Ground Speed	Displays the vehicle ground speed.
Area Applied	Displays the amount of area covered, sprayed, or spread, in acres or hectares.
COG	Course on Ground, displays the vehicle heading in degrees.
Off	When Off is selected, no message is displayed in this message slot.

Table 9: Text 1 Options

Text 2

To select the Text 2 setting, go Lightbar setup, scroll using **Up** or **Down** until <TEXT 2> is displayed in the text window, and press **Enter**. Using **Up** or **Down** scroll through the Text 2 pick list until the desired message is displayed in the text window. Press **Enter** to save the setting and advance to the STEER BAR? menu item.

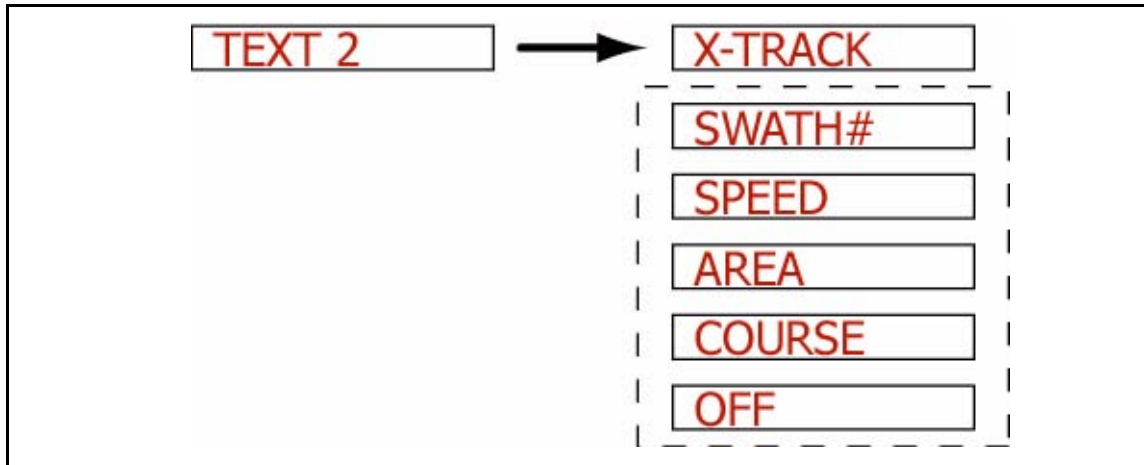

Figure 25: Selecting the Text 2 Message

Message	Description
X-Track	Displays the error (in distance) between the current guideline and the vehicle position.
Swath #	Displays the current guideline number.
Ground Speed	Displays the vehicle ground speed.
Area Applied	Displays the amount of area covered, sprayed, or spread, in acres or hectares.
COG	Course on Ground, displays the vehicle heading in degrees.
Off	When Off is selected, no message is displayed in this message slot.

Table 10: Text 2 Message Options

Steer Bar

The Steer Bar setting determines how the LED steering display appears. The LEDs, representing the vehicle track in relation to the current guideline, can be shown as a single LED or a solid bar (See Table 11).

To change the Steer Bar setting, go to Lightbar setup, scroll until <STEER BAR?> is displayed in the text window, and press **Enter**. Using **Up** or **Down**, scroll through the Steer Bar pick list until the desired setting is displayed in the text window. Press the **Enter** key to save the setting and return to the <SYSTEM> menu item.

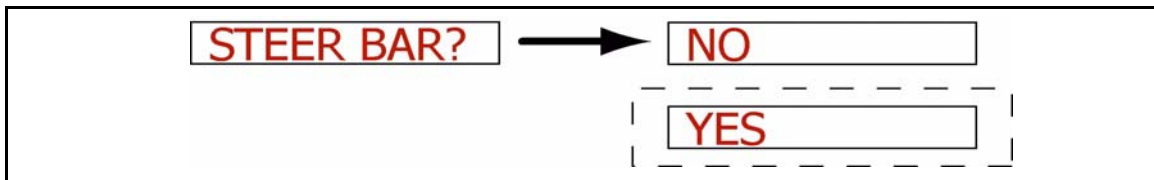

Figure 26: Setting the Steer Bar Option

Setting	Description
Off	The LEDs, representing the vehicle track in relation to the current guideline, are shown as a single LED.
On	The LEDs, representing the vehicle track in relation to the current guideline, are shown as a solid bar.

Table 11: Steer Bar Settings

System Setup

System setup allows the selection of settings that effect the entire CenterLine product. There are only two settings: Units and Language (See Table 12).

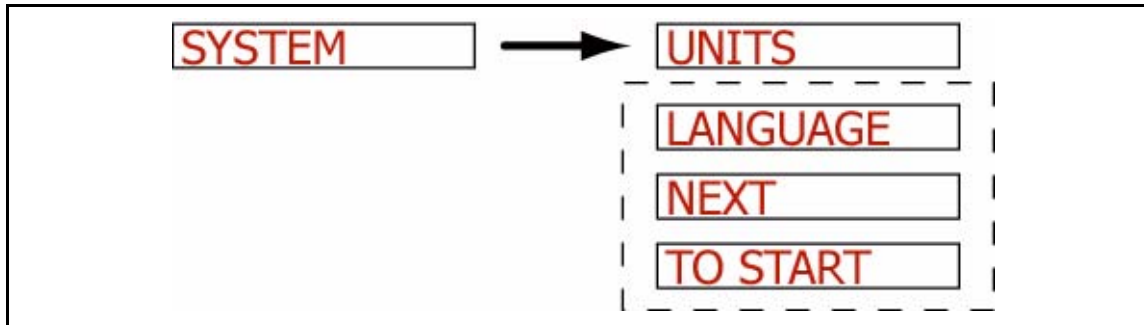

Figure 27: System Setup

Setting Name	Default Value	Change at 1st Time Start Up
Unit	US	Optional
Language	English	Optional

Table 12: System Menu Item Default Settings

Units

System Units allows the selection of either US and Metric units (See Table 13).

To change the System Units, enter System Setup, scroll through the sub-menu list until <UNITS> appears in the text window, and press **Enter**. Next scroll between the two units choices, <METRIC> and <US>. When the desired unit is displayed, press the **Enter** key. The software should bring you back to <UNITS>.

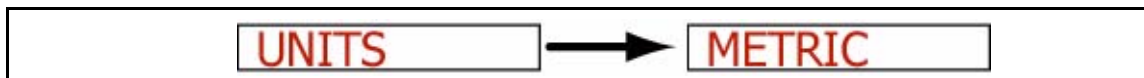

Figure 28: Setting System Units

Pick List	Description
US	All units are entered and displayed in Feet, Miles, and Acres. This is the default setting.
Metric	All units are entered and displayed in Meters, Kilometers, and Hectares.

Table 13: The Unit Menu Item Settings

Language

CenterLine comes pre-loaded with several languages. To change the system language, enter System Setup, scroll through the sub-menu list until <LANGUAGE> appears in the text window, and press **Enter**. Next scroll to the desired language using **Up** or **Down**. When the desired language is displayed, press the **Enter** key. The software should return to <NEXT>

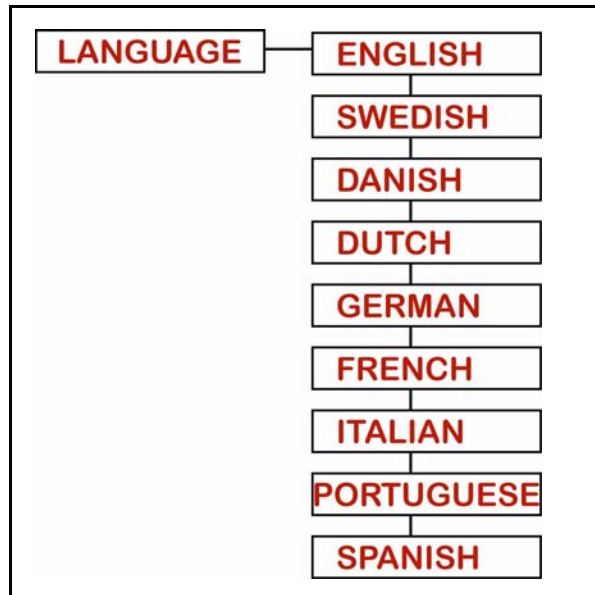

Figure 29: Setting the System Language

CenterLine Setup Flow Diagram

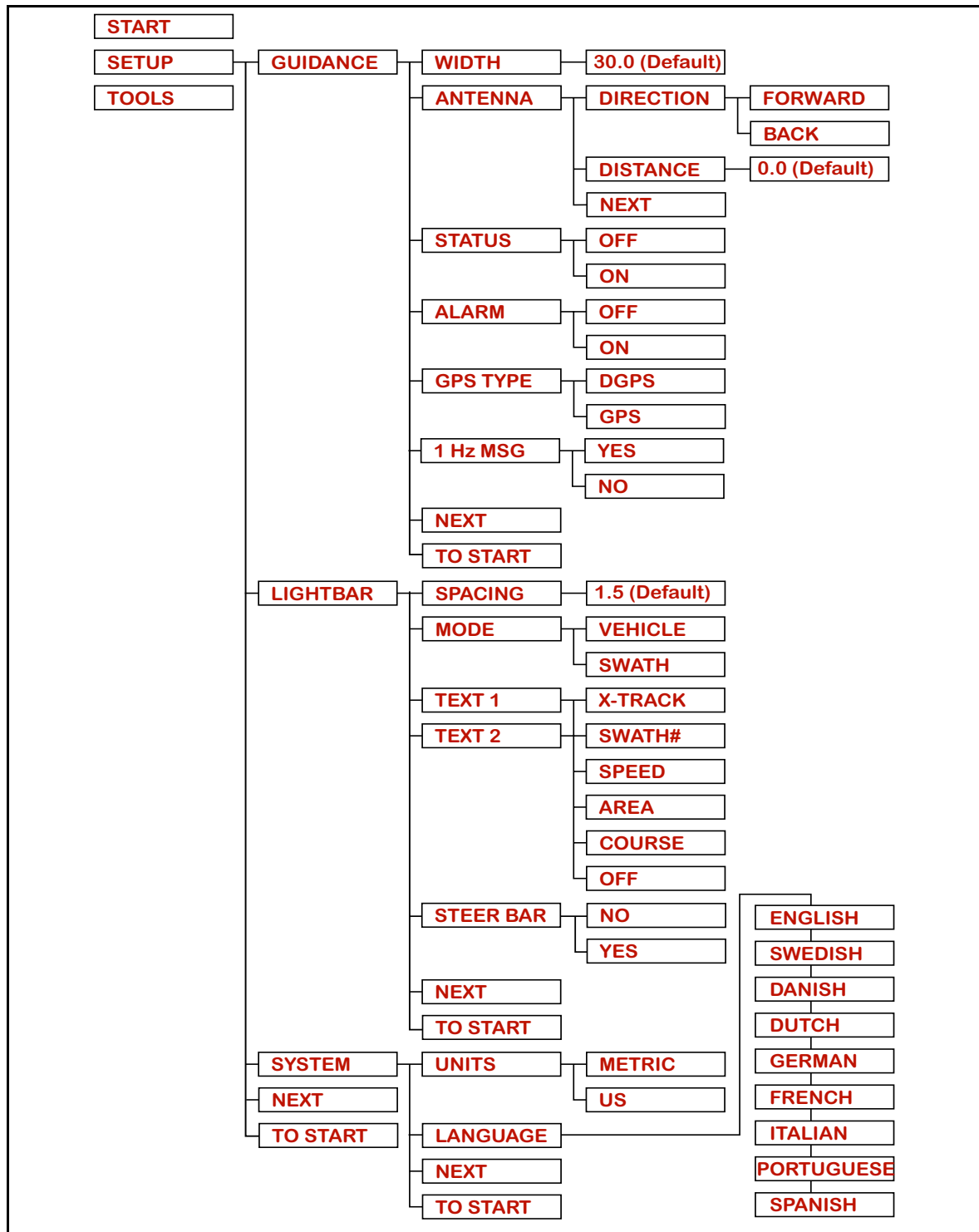

Figure 30: CenterLine Setup Flow Diagram

Tools

The Tools menu contains several functions to provide some basic system diagnostics (See Table 14).

To access Tools from the Setup menu, scroll until the text window displays <TOOLS>, and press **Enter**. <RECEIVER> should be displayed in the text window. Use **Up** or **Down** to scroll through the Tools menu.

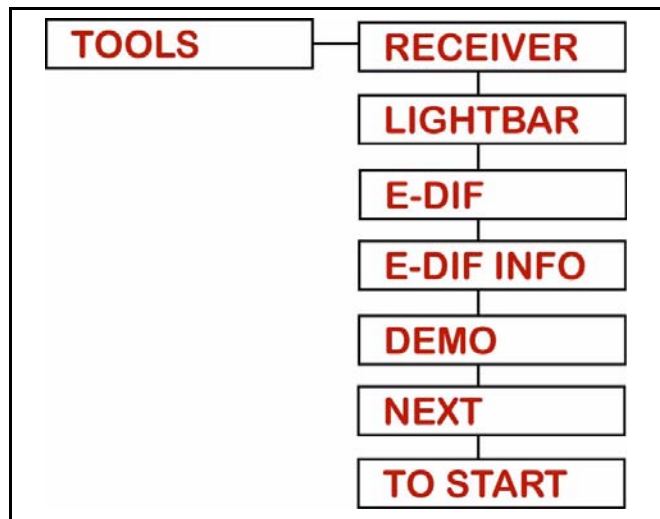

Figure 31: The Tools Menu Flow

Menu Item	Description
Receiver	Checks the status of a connected GPS receiver.
Lightbar	Tests the functionality of the CenterLine Lightbar LEDs and text window.
e-Dif	Only appears if an e-Dif GPS receiver is detected by the CenterLine system. Re-calibrates the e-Dif receiver.
e-Dif Info	Only appears if an e-Dif GPS receiver is detected by the CenterLine system. Displays current position information.
Demo	Activates a simulated CenterLine session.
Next	Advances to the next Setup menu item.
To Start	Returns the operator to the Start point of the menu.

Table 14: Tools Menu Items

Receiver

The Receiver diagnostic test queries the attached GPS receiver and returns its current configuration and status. This information is displayed in the text window on the lightbar.

To start the Receiver check, go to the Tools menu, scroll until <RECEIVER> is displayed in the text window, and press **Enter**. The lightbar displays the diagnostic messages shown in Table 15.

Diagnostic	Description
GPS Status	If the lightbar is not receiving GPS data, the text window message appears as <NO GPS>. If the lightbar is receiving GPS data but no differentially corrected GPS data, the text window message appears as <GPS>.
DGPS Status	If the lightbar is receiving differential corrected GPS data, the text window message appears as <DGPS>.
NMEA Strings	Returns the name of each NMEA string currently being received from the receiver. As an example if the NMEA GPGGA string is being received from the receiver then the text window displays <GGA>.
Data Rate	Returns the current receiver data rate. This is typically 5 Hz. The rate is displayed in the text window, e.g. <5 HZ> is displayed for the 5 Hertz data rate.

Table 15: Receiver Diagnostic Messages

Lightbar

The Lightbar diagnostic test initiates an illumination sequence of all of the LEDs and the text window, followed by a brightness control sequence. This allows the verification that all lights on the CenterLine lightbar are working properly.

To start the Lightbar check, go to <TOOLS> and press **Enter**. Scroll with **Up** or **Down** until <LIGHTBAR> is displayed in the text window and press **Enter**. The illumination sequence should start. When test is completed the lightbar displays <END>.

e-Dif

The accuracy of the position information provided by the e-Dif GPS receiver slowly deteriorates with time since the last calibration. Because of this, it is recommended that the e-Dif receiver be recalibrated about every 1 to 2 hours, to maintain the accuracy of the position information. The e-Dif tool allows the operator to re-calibrate the e-Dif receiver by coming to a stop and selecting e-Dif in the Tools menu or the Real time menu.

To re-calibrate the e-Dif receiver, go to <TOOLS> and press **Enter**. Scroll with **Up** or **Down** until <E-DIF> is displayed in the text window and press **Enter**. The text window displays <WAIT> until the receiver re-calibration is complete. The lightbar then displays <READY>.

e-Dif Info

The “e-Dif Info” function only appears when the CenterLine system detects that an e-Dif GPS receiver is present and calibrated. This receiver diagnostic test queries the attached e-Dif GPS receiver and displays current position information being generated. This information is displayed in the text window on the lightbar.

To start the e-Dif diagnostic test, go to the Tools menu, scroll until <E-DIF INFO> is displayed in the text window, and press **Enter**. The lightbar displays the diagnostic messages shown in Table 16.

Diagnostic	Description
Number of Satellites	Displays the number of satellites that are providing a reliable signal to the GPS receiver.
E Correction Age	Displays the time since the last re-calibration.
Current Last Position	Displays the latitude and longitude and height of the last re-calibration position.

Table 16: e-Dif Receiver Diagnostic Messages

Demo

The Demo mode displays simulated guidance information on the lightbar. This is used primarily by sales personnel to demonstrate the capabilities of the CenterLine system.

Next

The Next selection saves the setup information and returns the operator to the Start point on the CenterLine menu.

To Start

The Start selection saves the setup information and returns the operator to the Start point on the CenterLine menu.

CenterLine Real-Time Operation

Starting Real-time Operation

This section assumes that the setup section (See “CenterLine Setup” on page 13) has been read and the CenterLine lightbar properly set up.

Start real-time operation by pressing **Enter** when <START> is displayed in the text window. The <START> menu item is at the highest menu level. <START> can be easily reached from most menu levels by scrolling to <TO START> and pressing **Enter**. This jumps to the <START> location from anywhere in the menu structure (See Figure 30).

Figure 32 is a flow diagram of the CenterLine real-time operation and menu.

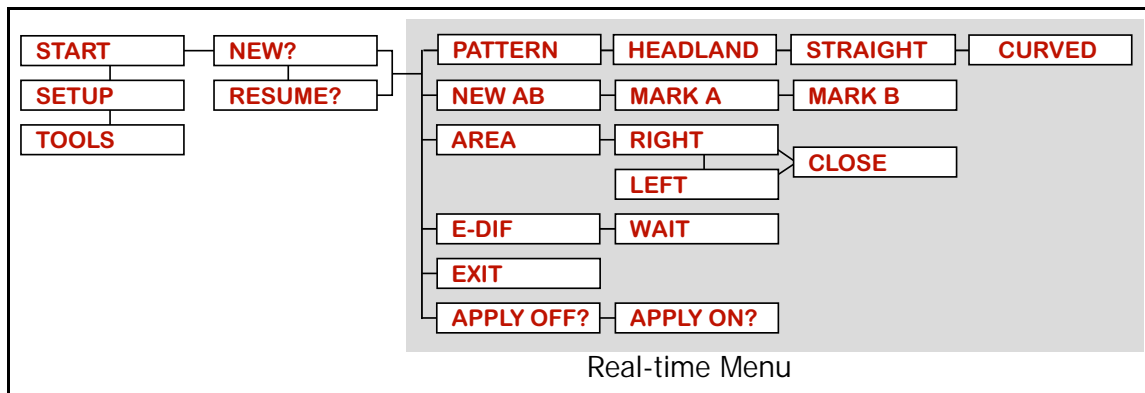

Figure 32: Real-Time Operation Flow Diagram

New? Resume?

When **Enter** has been pressed at the <START> location, a prompt to start a new field or resume working in the current field appears. During real-time operation, CenterLine stores the vehicle's trajectory data. This allows the operator to stop working in a field before finished and return at a later time, continuing where they left off. Only the current field is stored.

Use **Up** or **Down** to scroll between the <NEW?> and <RESUME?> menu items. Selecting <NEW?> clears the current field trajectory data and starts a new field in memory. Selecting <RESUME?> retains the current field trajectory data and allows the start of guidance using the existing data.

Real-time Operation

Real-time guidance begins when <NEW?> or <RESUME?> is selected. At this point, the GPS receiver should be properly connected to the CenterLine lightbar and running. See Figures 7-9 for diagrams showing how the DGPS receiver should be connected. The default guidance mode is Straight-Line Guidance and the current guidance mode is displayed in reverse video. The current guideline information is stored in memory, along with the field's trajectory data, is lost when <NEW?> is selected, and retained when <RESUME?> is selected. Only information for a single guideline is stored. While in Headland mode, A and B points can be marked for Straight-Line or Curved AB guidance.

Real-time Menu

During real-time operation, a real-time menu (See Figure 32 on page 32) is available that allows you to switch between guidance patterns, mark A and B points for straight-line or Curved AB guidance, start a new A-B line, and exit. The real-time menu is accessed by pressing **Up** or **Down** during guidance operation. When either of these keys is pressed, the guidance messages displayed in the text window are replaced by the real-time menu (See Figure 32 on page 32). Use **Up** and **Down** to scroll through the menu and press **Enter** to select an item. The real-time menu times out when 5 seconds have passed and no arrow keys have been pressed.

Apply On/Off

If no switchbox or boom sense cable is being used and the <GUIDANCE><STATUS> setting (See "Status" on page 17) is set to off, Apply On/Off information must be provided to the CenterLine system manually. To toggle the Apply On/Off status, scroll the real-time menu (See Figure 32 on page 32) until <Apply on> or <Apply off> appears in the text window. Pressing **Enter** switches to the status displayed.

NOTE: This does not turn the application on and off. It only notifies the CenterLine system of the application status. <Apply on> and <Apply off> do not appear if <GUIDANCE><STATUS> is set to ON.

Marking A and B Locations

The Straight-line and Curve AB guidance modes require a reference guideline to guide the vehicle along. Establishing a guideline involves marking two points along the reference guideline. To establish this reference guideline using the real-time menu, use **Up** or **Down** to scroll in the menu until <NEW AB?> is displayed on the lightbar (See Figure 33), and press **Enter**. The menu item <MARK A> is displayed. Mark the A location by pressing **Enter** when the desired location is passed. The menu item <MARK B> is now displayed. To mark the B location, press **Enter** when the desired location is passed. The reference guideline is now established and the lightbar displays guidance information. See the underlined caution under “Curve AB Guidance Operation” on page 45, when establishing AB guideline for Curve AB operation.



Figure 33: The Mark A Mark B Sequence

Switching between Guidance Modes

There may be situations where it is necessary to switch between guidance modes. Typically an operator makes one or more passes around the field's headland area in the Headland guidance mode. While driving the headlands, the operator may mark the A and B guideline points to be used when switching modes. When the headlands are completed, the operator switches to the Straight-line or Curve AB mode, and completes the field in a back and forth fashion.

To switch between guidance modes, scroll the real-time menu (See Figure 32 on page 32) until <HEADLAND>, <STRAIGHT>, or <CURVE AB> appears in the text window. When the desired mode is displayed, press **Enter** to make it active.

CenterLine

Software Version 1.07

Area Determination

The area of the current job or field is important information. CenterLine allows the determination of the area of a field by driving the perimeter of the field. This can be conveniently done while driving the first headland circuit in Headland mode.

To determine the area of a field, scroll the real-time menu until <AREA> is displayed (See Figure 34 on page 35) and Press **Enter**. The lightbar displays <LEFT> or <RIGHT>. Using **Up** or **Down**, select the side of the swath or implement that is closest to the field boundary. Press **Enter** to start area calculation. The lightbar displays <↵ Map BND> or <Map BND ↵>. When ready to close the boundary, scroll the real-time menu (Figure 32) until <CLOSE> is displayed. Press **Enter** to close the boundary and determine the area. Pressing <CLOSE> inserts a line between the starting location and the current location and uses that shape to determine area.

The area is automatically determined when the vehicle drives within 4.5 meters (15 feet) of the starting point.

The bounded area is displayed on the lightbar as a part of the guidance message stream for three minutes and when stopped in an “applied” area.

If a bounded area has already been determined, the <VIEW> menu item is present. Pressing **Enter** at the <VIEW> level displays the current bounded area value.

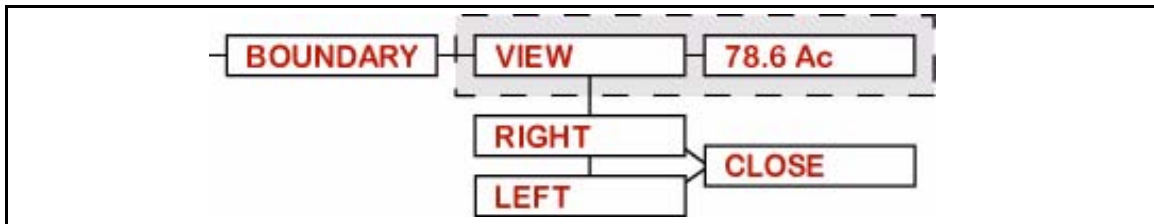



Figure 34: Area Determination Flow Diagram

Return to Point

 CenterLine allows the operator to mark a point in the field to return to later in time. Typically the Return to Point feature is used to mark a location when stopping guidance and wanting to start in the same location and in the same direction at a later time. This Return to Point location is stored with the field's trajectory data, is lost when <NEW?> is selected, and retained when <RESUME?> is selected.

There is a specific **Return to Point** key located on the wireless remote, see Figure 4. This key works in toggle fashion; press it once to mark the point (the lightbar displays <→◆←>), press it again to navigate back to the point. Stop the navigation process by pressing **ESC**. When **Return to Point** is pressed again (third time) the old location is replaced with the current vehicle location.

While operating in the **Return to Point** mode, no active text messages are displayed except error messages. If the vehicle enters an area that has already been applied, the display alternates between the **Return To Point** distance and <Applied!>.

Exiting Real-time Operation

To exit guidance, press **Esc** or scroll with **Up** or **Down** in the real-time menu until <EXIT?> is displayed (Figure 35) in the text window and Press **Enter**. <BYE> appears in the text window, real-time operation stops, and the display returns to the main menu.

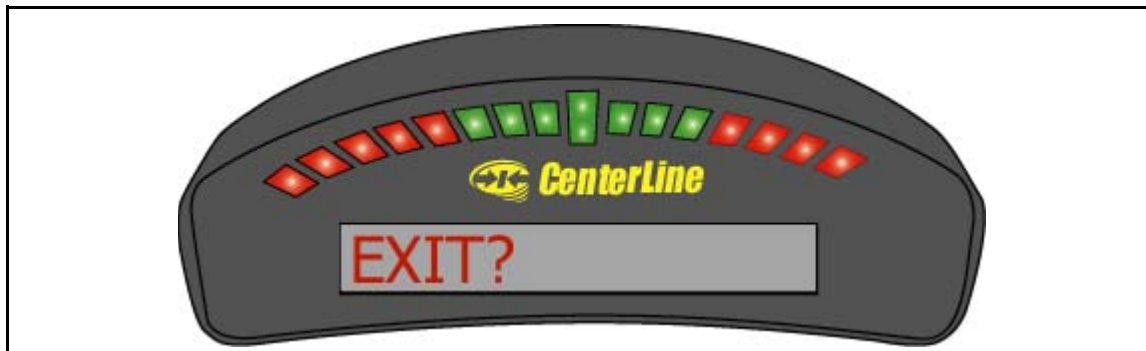

Figure 35: Exit in Display

Headland Guidance Operation

This section describes how to operate CenterLine in the Headland guidance mode. The Headland mode is used when the operator wants to drive several circuits around the field boundary and be guided around all circuits that occur after the first. When several headland circuits have been completed, the operator has the option of switching to the Straight-line mode. The Headland pattern is also used when a user wants to do product application on terraced fields. In the Headland curved guidance pattern, the operator can pull along side any previous applied swath and be guided parallel to that swath by the X-Track guidance display.

To select the Headland guidance mode, scroll with **Up** or **Down** in the real-time menu until <HEADLAND> is displayed. If <HEADLAND> is not displayed in reverse video, press **Enter**. This switches the guidance mode to Headland. If <HEADLAND> is displayed in reverse video, the system is already in Headland mode.

Reference Guideline

While operating in the Headland mode, the user has the option to mark the A and B points of the reference guideline used in the Straight-line or Curve AB Guidance mode. This feature makes it easier for the operator to Mark the A and B points while in Headland mode applying the headlands. It is always best to mark the A and B points for the Straight-line or Curve AB mode while driving along a straight edge of a field. See the underlined caution under “Curve AB Guidance Operation” on page 45, when establishing AB guideline for Curve AB operation. For more detail on how to establish a reference guideline see “Marking A and B Locations” on page 34.

The operator remains in the Headland mode until the guidance mode is changed using the real-time menu (see “Switching between Guidance Modes” on page 34). The reference guideline can be used for Straight-line and Curve AB mode.

Headland Pattern Example

In this example the operator wants to apply two headland passes to the field and then switch to Straight-line mode and apply the remainder of the field with straight-line parallel swath guidance. After the first headland circuit the operator pulls parallel to the first circuit swath and begins applying the second circuit while being guided parallel to the first circuit.

Figure 36 on page 38 shows the operator just finishing the first headland circuit. When the operator pulls along side the first headland circuit, curved guidance automatically starts. The operator is now able to drive the second headland circuit parallel to the first circuit by following the guidance information displayed on the lightbar.

Figure 37 on page 38 shows the operator being guided along side the initial headland circuit. The lightbar automatically supplies guidance information. For more details on how to interpret curved guidance information on the lightbar (See “Headland Mode Lightbar Graphics” on page 41).

Figure 38 on page 39 shows the operator continuing to drive around the second headland circuit.

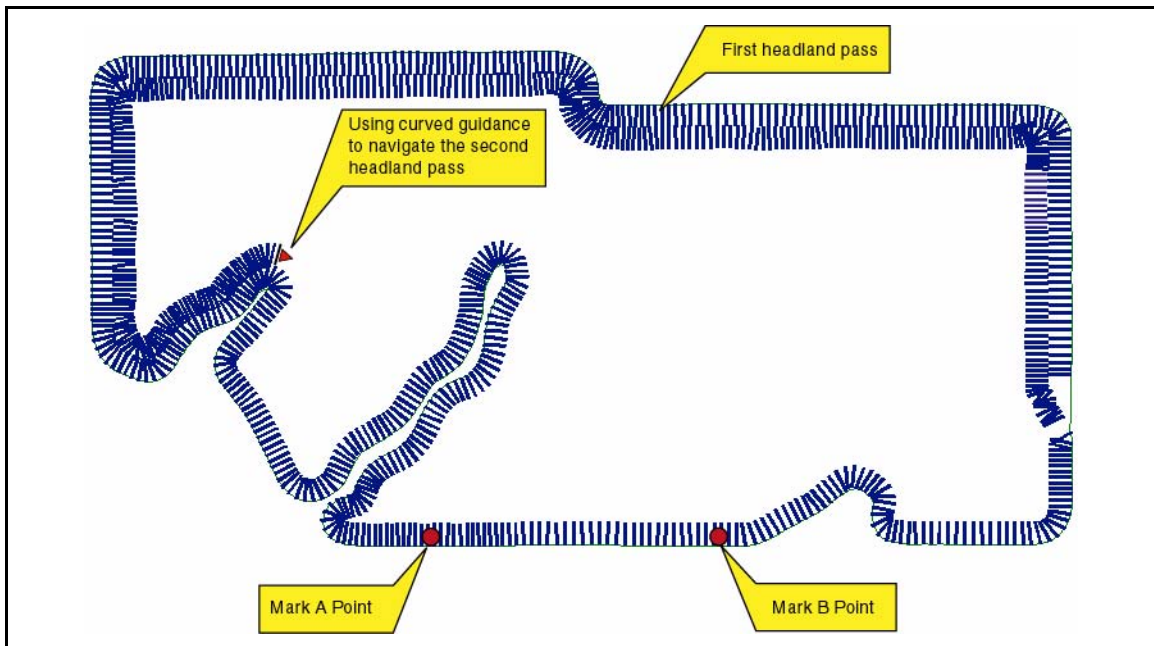

Figure 38: Continuing Around the Second Circuit.

Switching from Headland to Straight-line Mode

When the operator has completed the desired number of headland circuits, two circuits in our current example, the system is switched to Straight-line Guidance mode to apply the remainder of the field in a straight back and forth fashion.

To switch from the Headland Pattern to another pattern, see “Switching between Guidance Modes” on page 34. If the operator is being guided along a curved path when the pattern is switched, the lightbar no longer guides them along the curved path.

If a reference guideline was established while in the Headland Guidance mode, CenterLine automatically guides the vehicle along the closest parallel line as soon as the operator switches to the Straight-line mode. If a reference guideline was not established during the Headland mode, then the operator must mark the A B points. The lightbar displays the <MARK A> message, indicating that no reference guideline exists.

Figure 39 shows the operator applying product in Straight-line mode. Because a reference guideline was established during the curved guidance process, the user can immediately start straight-line guidance as soon as the guidance mode button is pressed.

Headland Mode Lightbar Graphics

CenterLine's Headland mode guidance technique employs a lightbar text display graphic that aids the operator when navigating parallel to a curved swath. The X-Track LED functionality that is employed in Straight-line and Curve AB modes is also employed when driving in Headland mode.

A projected swath-path graphic is displayed in the text display area of the lightbar (See Figure 41). This projected path is made up of four horizontal bars. The bottom bar represents the path closest to the vehicle and the top bar is the path furthest away. The width of the bars decrease as they move away from the vehicle to add a perspective view to the path ahead of the vehicle. The projected distance of the first bar from the front of the vehicle is based on the vehicle speed. The lightbar in Figure 41 informs the user to drive straight, and there are no turns approaching. In Figure 42 the lightbar indicates the vehicle is approaching a turn to the right. The X-Track LEDs indicate that the vehicle is slightly to the right of the guideline. Lightbar X-Track LEDs are set up in Swath mode. Therefore the user must correct to the left to get back on line. The X-Track LEDs do not provide any information relating to the curved path ahead of the vehicle, they only indicate where the vehicle is with respect to the guideline at the current vehicle location. The lightbar displays a "hollow" path during the first headland pass to indicate that no guidance information is available yet (The first pass must be completed before a parallel path can be established) (See Figure 43).

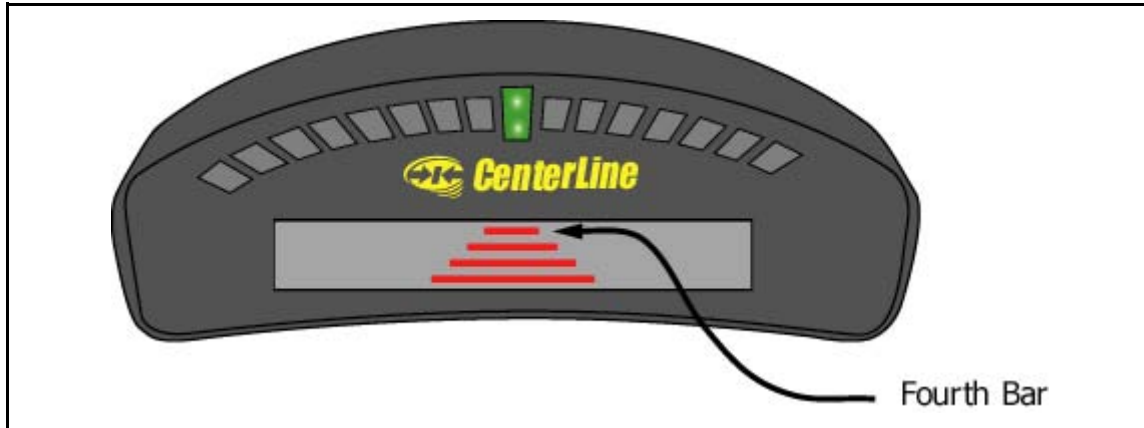

Figure 41: Curved Guidance Lightbar Graphics

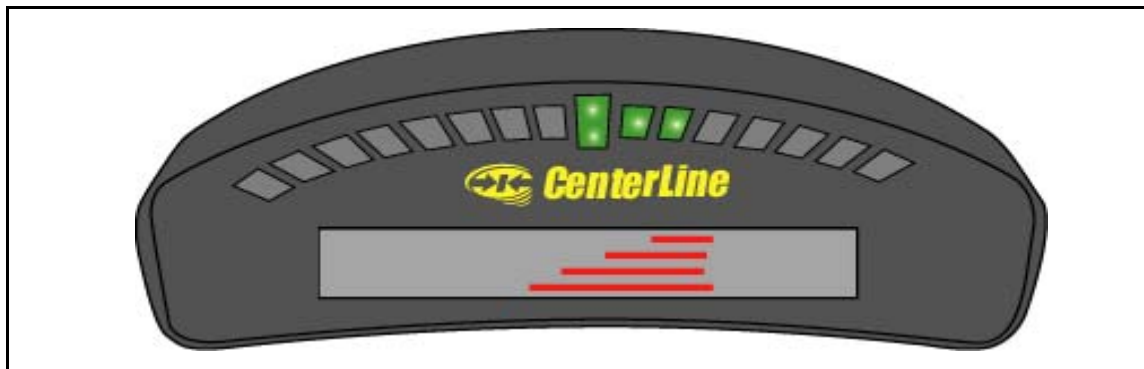

Figure 42: Right-Hand Turn Ahead

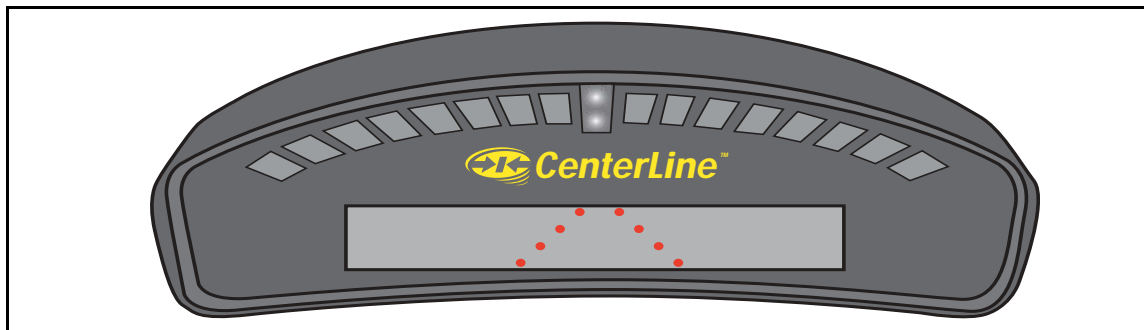

Figure 43: Hollow Path

Straight-line Guidance Operation

The Straight-line guidance mode provides vehicle guidance along straight lines, based on a reference guideline. The first step is to establish the reference guideline. This reference guideline is used to calculate all other parallel guidelines. See “Marking A and B Locations” on page 34 for more detail on how to establish a reference guideline.

To mark the initial point A, begin driving along the first swath path. Typically this is along a straight edge of a field boundary. While the vehicle is driving along the initial swath, the lightbar displays <MARK A>. As the vehicle passes over the desired A location, press **Enter** to establish the guideline point A.

The lightbar now displays <MARK B>. The next step is to establish guideline point B. To do this, press **Enter** as the vehicle passes over the desired B location. This establishes the reference guideline. The lightbar starts displaying X-Track guidance information as well as any user selected messages defined in Lightbar setup (See “Lightbar Setup” on page 21). If the vehicle is too far from the previously applied area to determine guidance information, a “Hollow” path is displayed (See Figure 43 on page 42).

When the reference guideline is established, the operator can begin driving straight-line guidance. The CenterLine software detects which guideline is closest to the centerline of the vehicle and provides guidance information with respect to that line. As the vehicle moves across the field (Figure 44) new guidelines, parallel to the reference guideline, are established based on the swath width value entered in Guidance setup.

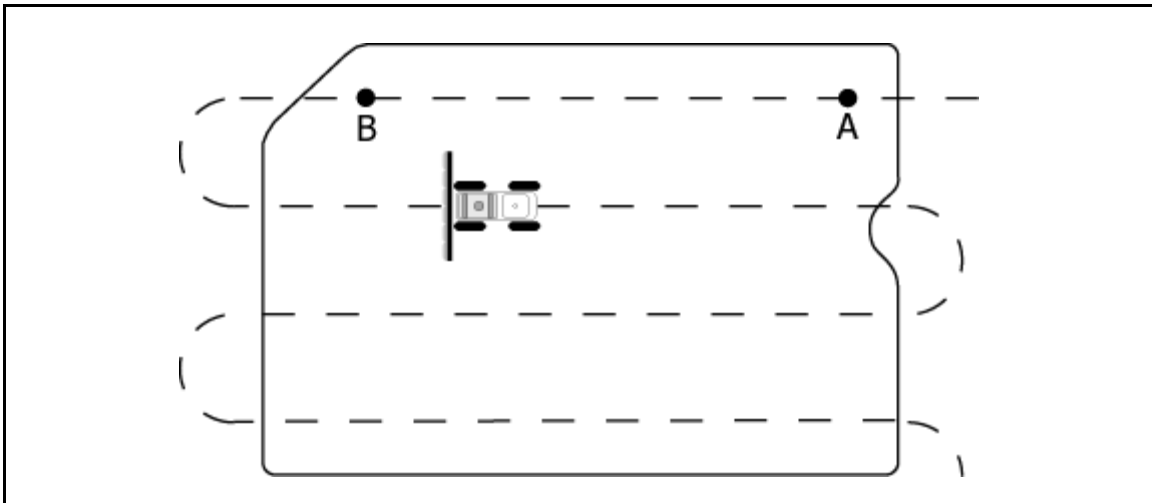

Figure 44: Working a Field in the Straight-line Guidance Mode

When making a turn at the end of the field, the lightbar displays the distance to the next swath (see Figure 45).

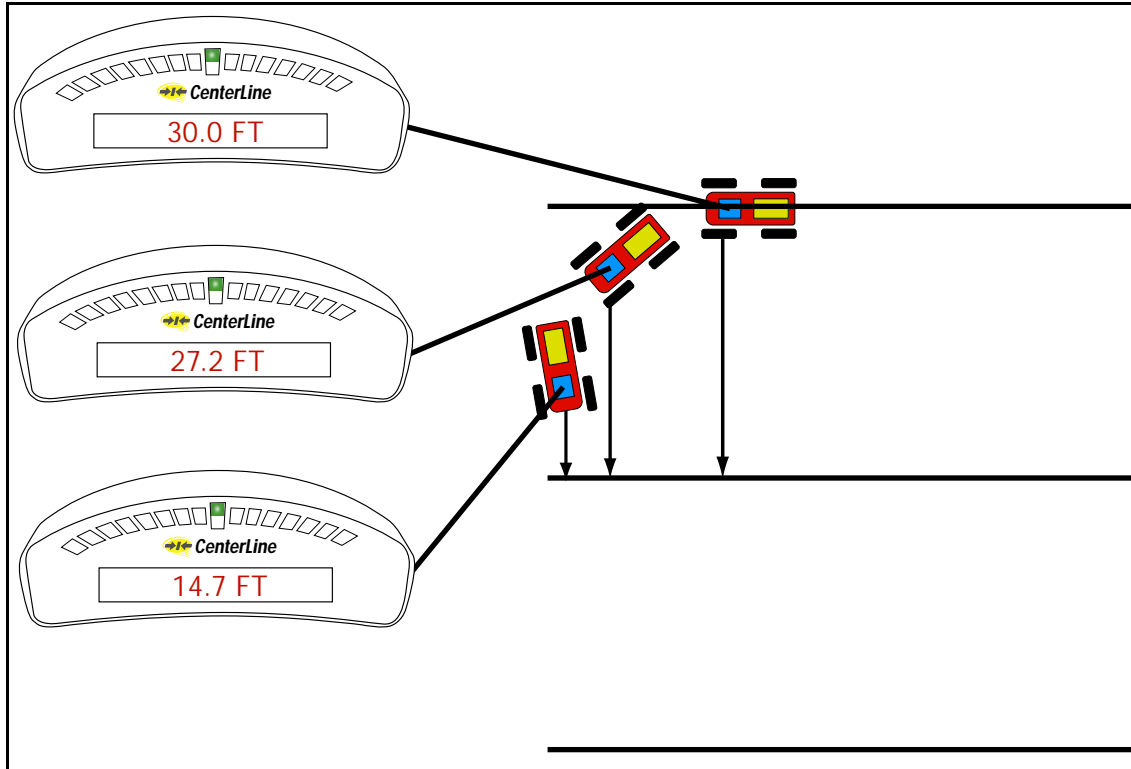

Figure 45: Distance to Next Straight Swath

Curve AB Guidance Operation

The Curve AB guidance mode works similar to Straight-Line mode except it provides vehicle guidance along curved lines, based on a curved reference guideline. The first step is to establish the reference guideline. This reference guideline is used to calculate all other parallel guidelines. See “Marking A and B Locations” on page 34 for more detail on how to establish a reference guideline.

To mark the initial point A, begin driving along the first swath path (See Figure 46). **It is recommended that the reference guideline be established along the longest side of the field, if possible, because the curved guidelines do not extend beyond the A and B points (See Figure 47). This can leave areas of the field where guidance information is not available.** While the vehicle is driving along the initial swath, the lightbar displays <MARK A>. As the vehicle passes over the desired A location, press **Enter** to establish the guideline point A.

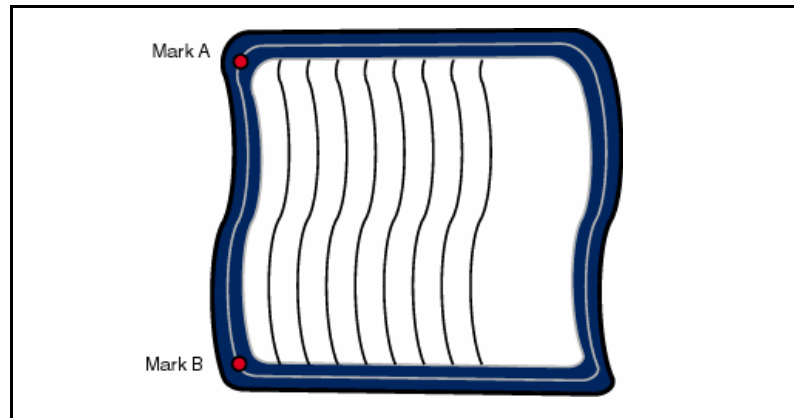

Figure 46: Marking AB Line in Curved Guidance

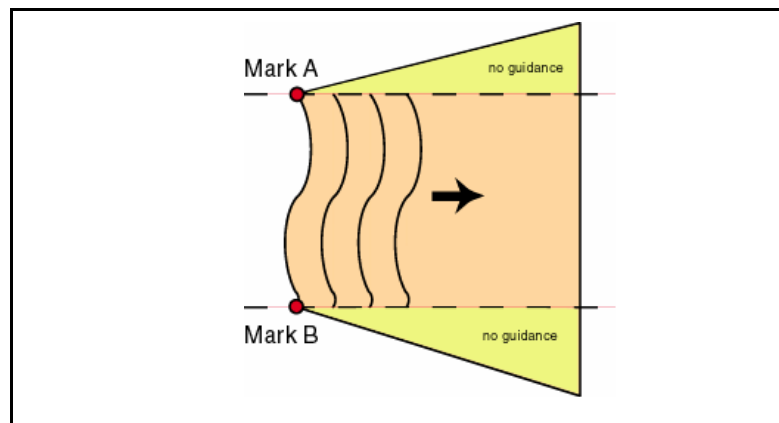

Figure 47: Curve AB Mode guideline limitations

CenterLine

Software Version 1.07

The lightbar now displays <MARK B>. The next step is to establish guideline point B. To do this, press **Enter** as the vehicle passes over the desired B location. This establishes the reference guideline. The lightbar starts displaying X-Track guidance information as well as any user selected messages defined in Lightbar setup (See "Lightbar Setup" on page 21). If the vehicle is too far from the previously applied area to determine guidance information, a "Hollow" path is displayed (See Figure 43 on page 42).

When the reference guideline is established, the operator can begin driving Curve AB guidance. The CenterLine software detects which guideline is closest to the centerline of the vehicle and provides guidance information with respect to that line. As the vehicle moves across the field (Figure 46) new guidelines, parallel to the reference guideline, are established based on the swath width value entered in Guidance setup. When making a turn at the end of the field, the lightbar displays the distance to the next swath (see Figure 48).

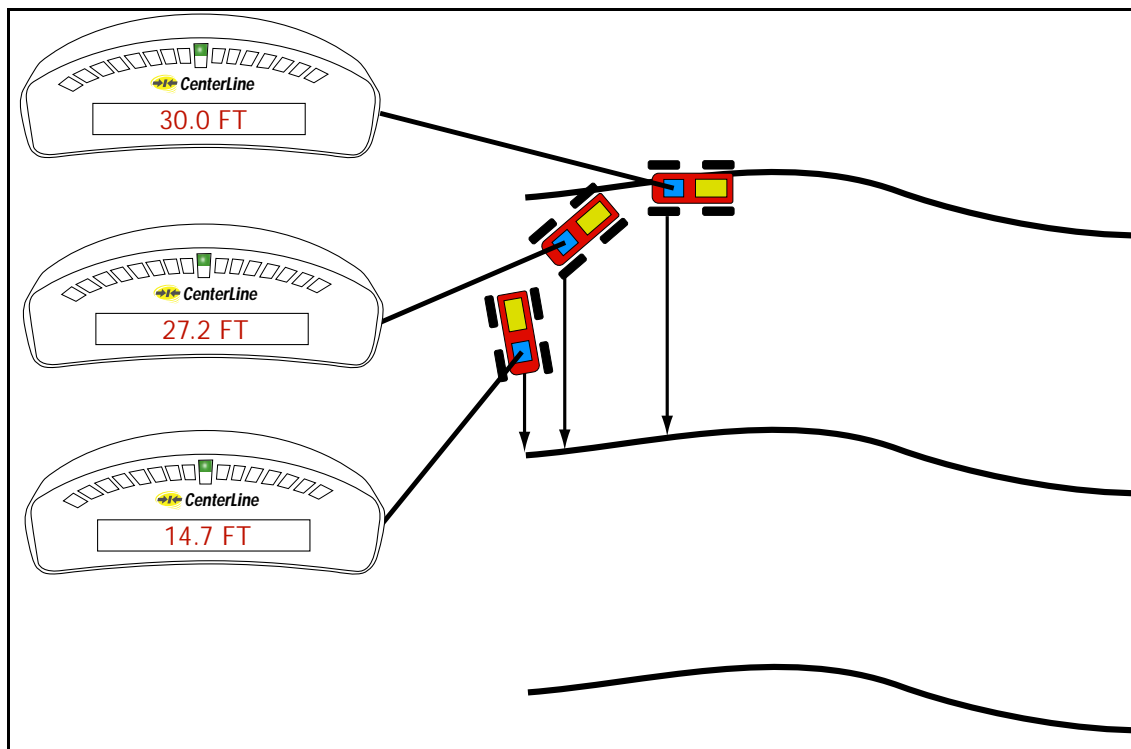

Figure 48: Distance to Next Curved Swath

Applied Area Detection

CenterLine allows the detection of a previously applied area. To use applied area detection, the Lightbar Setup - Alarm menu field must be set up prior to starting guidance. See “Alarm” on page 18 of this User Guide for more details on how to set up this menu field.

Detecting A Previously Applied Area

Figure 49 shows how previously applied area detection works. As the vehicle enters a previously applied area, the lightbar displays the message APPLIED, even if the application is turned off. When the vehicle exits the previously applied area, the APPLIED message stops displaying.

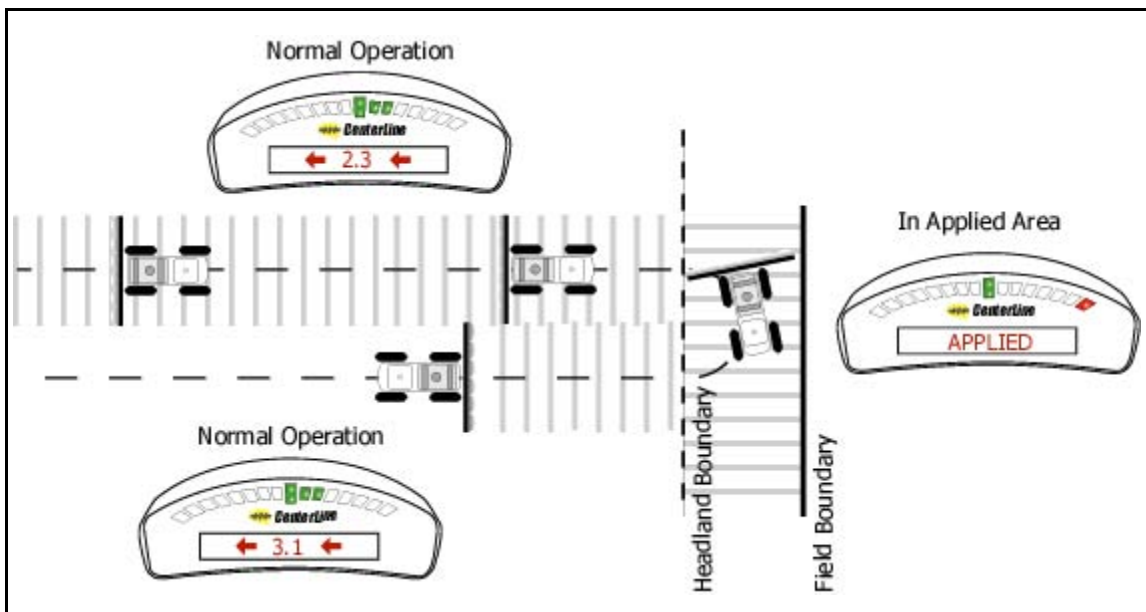

Figure 49: Applied Area Detection in Headlands

Detecting Neighboring Swath

Applied area detection notifies the user when the vehicle crosses into a previously applied neighboring swath. Figure 50 shows an Applied Area Overlap example. The vehicle can overlap up to 25% of the Swath Width without being notified. Once the edge of the vehicle swath overlaps 25% or more into a neighboring swath, the lightbar displays <APPLIED>.

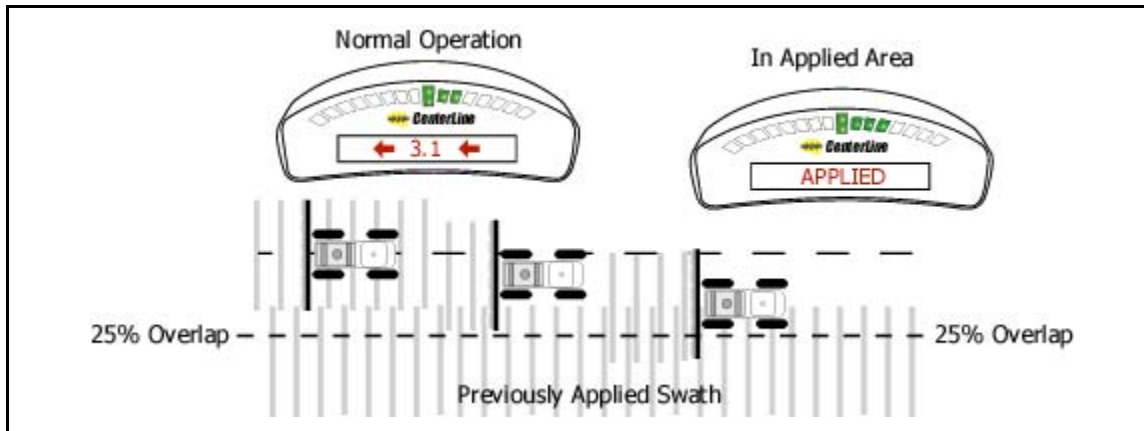

Figure 50: Applied Area Overlap in Neighboring Swath

Lightbar Index

The CenterLine lightbar is capable of displaying a considerable amount of information to the user. This information can be represented as text in the display window, illuminated cross track LEDs, or a combination of text and lights. Information displayed on the lightbar depends on both user defined settings and system warnings not controlled by the user. Table 17 describes each possible lightbar state and possible information that could be displayed.





Lightbar State	Description
	<p>Mark A: Displayed when establishing the guidance point A of the reference guideline.</p>
	<p>Mark B: Displayed when establishing the guidance point B of the reference guideline.</p>
	<p>Swath #: A user selected lightbar message. When not on the initial guideline the first character is either L or R for Left and Right of the initial guideline. The number identifies how many lines left or right of the initial guideline.</p>
	<p>X-Track Error: A user defined lightbar message. This cross track error message is displayed when the vehicle is on the guideline and there is no error.</p>
	<p>X-Track Error: A user defined lightbar message. In this example the operator should steer to the left 2.3 ft. (Assuming that System Units is set to US and Lightbar is set to Swath mode.)</p>

Table 17: CenterLine Lightbar Index



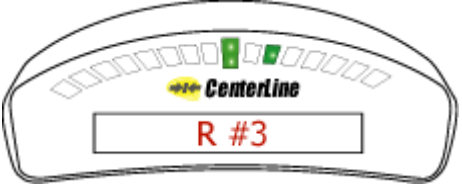

Lightbar State	Description
 <p>The lightbar display shows the CenterLine logo at the top, followed by a row of 16 indicator lights. The 10th light from the left is illuminated green. Below the lights, a white box contains the text "16.3 MPH" in red.</p>	<p>Ground Speed: A user defined lightbar message indicating the vehicle speed in Miles per Hour (MPH). System Units is set to US.</p>
 <p>The lightbar display shows the CenterLine logo at the top, followed by a row of 16 indicator lights. The 10th light from the left is illuminated green. Below the lights, a white box contains the text "35.2 KPH" in red.</p>	<p>Ground Speed: A user defined lightbar message indicating the vehicle speed in Kilometers per Hour (KPH). System is Units set to Metric.</p>
 <p>The lightbar display shows the CenterLine logo at the top, followed by a row of 16 indicator lights. The 10th light from the left is illuminated green, and the 15th light from the left is illuminated green. Below the lights, a white box contains the text "COG 180" in red.</p>	<p>Course on Ground (COG): A user defined lightbar message indicating the vehicles heading in degrees 0 to 359. The example to the left indicates the vehicle's course on the ground is due South (180 degrees).</p>
 <p>The lightbar display shows the CenterLine logo at the top, followed by a row of 16 indicator lights. The 10th light from the left is illuminated green. Below the lights, a white box contains the text "78.9 AC" in red.</p>	<p>Area Applied: A user defined lightbar message indicating the current amount of area applied in Acres. System Units is set to US.</p>
 <p>The lightbar display shows the CenterLine logo at the top, followed by a row of 16 indicator lights. The 10th light from the left is illuminated green. Below the lights, a white box contains the text "31.9 HA" in red.</p>	<p>Area Applied: A user defined lightbar message indicating the current amount of area applied in Hectares. System Units is set to Metric.</p>
 <p>The lightbar display shows the CenterLine logo at the top, followed by a row of 16 indicator lights. The 10th light from the left is illuminated green, and the 16th light from the left is illuminated red. Below the lights, a white box contains the text "APPLIED" in red.</p>	<p>Applied Area Detection: This message is displayed when the vehicle is within a previously applied area. Note that the Red stop light (far right light) is illuminated. See "Applied Area Detection" on page 47.</p>

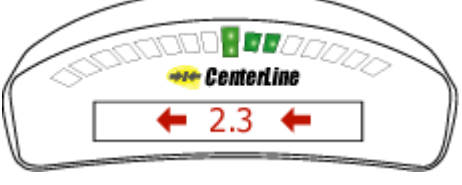
Table 17: CenterLine Lightbar Index



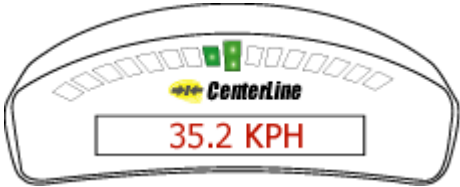

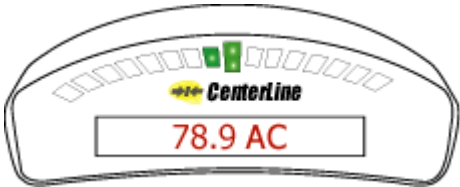

Lightbar State	Description
	<p>Curved guidance information graphics. The four horizontal bars in the text display represent a perspective view of the swath ahead of the vehicle. The bars skew left or right to represent the curved path ahead.</p>
	<p>Curved guidance information graphics. The path in the text display represents a perspective view of the swath ahead of the vehicle. The "hollow path" indicates that the vehicle is making the first headland pass and no guidance information is available yet. The path skews left or right to represent the curved path ahead. This is also displayed when in guidance mode but the vehicle is not moving.</p>
	<p>Mapping Boundary: This message is displayed when the user is mapping the field boundary. The arrow symbol on the left indicates the field boundary is on the left side of the vehicle.</p>
	<p>Mapping Boundary: This message is displayed when the user is mapping the field boundary. The arrow symbol on the right indicates the field boundary is on the right side of the vehicle.</p>
	<p>System Warning: The message is displayed when there is loss of differential GPS corrections. Guidance calculations are stopped until differential corrections resume.</p>
	<p>System Warning: This message is displayed when there is a complete loss of GPS signal to the GPS receiver or Smartpad. Guidance calculations are stopped until DGPS signal resumes.</p>

Table 17: CenterLine Lightbar Index

Lightbar State	Description
 <p>The diagram shows a lightbar display with a curved top edge. It features a row of 12 colored segments (alternating red and green) along the top. Below the segments is the 'CenterLine' logo, which consists of a yellow circle with a black 'CL' inside, followed by the text 'CenterLine'. At the bottom of the display, there is a white rectangular box containing the text 'Ver 1.07' in red.</p>	<p>Lightbar Version Message: This message is displayed when the user starts up CenterLine or runs the Lightbar Test. This number varies and is based on lightbar version and model.</p>

Table 17: CenterLine Lightbar Index



Midwest Technologies
2864 Old Rochester Road
Springfield, IL 62703

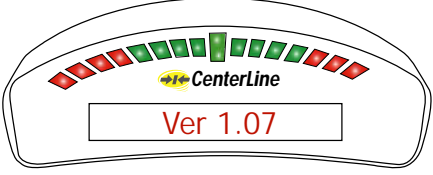