

ARC 6000 CONSOLE



USER GUIDE

PN: 98-05012

QUICK START REFERENCE

The following items should be checked before starting each days operation. The **BOLD TYPE** designates the switch positions required to view the information mentioned. (For detailed information, or if this is the initial setup for the machine, see Chapter 2.)

1. Application Rate - **APPLICATION RATE/OPERATE**
2. Clear accumulators
 - A. Area Accumulators - There are two area accumulators that can be reset individually. Select the desired area accumulator and hold down the INC/DEC switch until the display reads zero.
 - 1) **FIELD AREA/DEC**
 - 2) **TOTAL AREA/DEC**
 - B. Volume Accumulator - **TOTAL APPLIED/OPERATE/DEC**
3. Load Volume
 - A. Full Load Volume - If you are starting with a new load, set the "Full Load Value" by selecting **PRODUCT VOL./OPERATE** and holding the INC/DEC switch up for at least three seconds.
 - B. Partial Load Volume - Select "Full Load Value" as described in 4.A above. Then hold down on the INC/DEC switch until the display reads the actual volume loaded into the tank.

QUICK SET UP REFERENCE

1. Perform the items found in the Quick Start Reference above plus the items below.
2. Select U.S./Metric Units - **SPEED/OPERATE** - Use INC/DEC switch to select.
 - A. **INC** to select Metrish
 - B. **DEC** to select U.S. and Metric
3. % Rate Change - **% RATE/SET-UP**
4. GSO Speed - **SPEED/SET-UP**
5. Test Speed - **TEST SPEED/SET-UP or OPERATE**
6. Field Area Alarm - **FIELD AREA/SET-UP**
7. Console Calibration Numbers
 - A. Distance Cal. # - **DISTANCE/SET-UP**
 - B. Flow meter Cal. # - **TOTAL APPLIED/SET-UP**
 - C. Boom Widths - **IMPL. WIDTH/SET-UP** - All booms **OFF**. Check each individual boom section as it is displayed. All unused boom sections should be set to zero.
8. Setting Hold/Close Response
 - A. Implement Status Off - **TOTAL APPLIED/OPERATE** - Hold INC/DEC switch up. Will cycle between Hold and Close.
 - B. All Booms Off - **IMPL. WIDTH/OPERATE** - Hold INC/DEC switch up. Will cycle between Hold and Close.

TABLE OF CONTENTS

TABLE OF CONTENTS	I
LIST OF ILLUSTRATIONS	III
REVISION LOG	III
HOW TO USE THIS MANUAL	IV
CHAPTER 1 SWITCHES AND CONTROLS	1-1
CONSOLE SWITCHES AND INDICATORS	1-1
DISPLAY SELECTOR SWITCH	1-2
DISPLAY SELECTOR FUNCTIONS - OPERATE MODE	1-2
DISPLAY SELECTOR FUNCTIONS - SETUP MODE	1-3
STATUS SWITCH	1-4
GROUND SPEED OVERRIDE SWITCH	1-5
CHAPTER 2 CALIBRATION	2-1
ENGLISH, METRIC, OR METRISH UNITS	2-1
SETTING APPLICATION RATES	2-2
SETTING THE % RATE CHANGE	2-3
SETTING BOOM WIDTHS	2-3
DISTANCE CALIBRATION - GROUND SPEED SENSOR	2-4
FLOW METER CALIBRATION	2-7
SETTING THE HOLD/CLOSE RESPONSE	2-10
SETTING THE TEST SPEED VALUE	2-11
SETTING THE GROUND SPEED OVERRIDE (GSO) VALUE	2-12
SETTING THE FIELD AREA ALARM	2-13
PRODUCT VOLUME (FULL LOAD VALUE)	2-13
CHAPTER 3 OPERATION	3-1
NORMAL START-UP AND OPERATION	3-1
CHANGING ACTIVE BOOM SECTIONS	3-2
CHANGING APPLICATION RATE	3-2
PRIMING THE MAIN PUMP AND BOOM	3-4
GROUND SPEED OVERRIDE	3-4
CHAPTER 4 MAINTENANCE	4-1
FLUSHING AND CLEANING	4-1
CONTROL CONSOLE	4-1
GROUND SPEED SENSOR	4-2
FLOW SENSOR	4-2
FLOW CONTROL VALVE	4-3
WIRING HARNESS	4-3
CHAPTER 5 TROUBLE SHOOTING - ERROR MESSAGES	5-1
CHAPTER 6 EMERGENCY OPERATION	6-1
GROUND SPEED SENSOR FAILURE	6-1
FLOW CONTROL VALVE FAILURE	6-2
FLOWMETER FAILURE	6-4
APPENDIX A - SYSTEM DIAGRAMS	A-1
APPENDIX B - SYSTEM OVERVIEW	B-1
HOW THE ARC CONTROLS APPLICATION RATE	B-2
ARC SYSTEM COMPONENTS	B-2
APPENDIX C - GLOSSARY/TABLES	C-1
GLOSSARY	C-2
USEFUL FORMULAS	C-6
ENGLISH/METRIC CONVERSION	C-6
MISCELLANEOUS NOTES	C-8
CALIBRATION NUMBERS	C-8

MID-TECH, Auto-Range, & TASC are all registered trademarks of Midwest Technologies, Inc.

This page left blank intentionally

List of Illustrations

FIG. 1-1. ARC CONSOLE - SWITCHES AND INDICATORS	1-1
FIG. 1-2. DISPLAY SELECTOR FUNCTIONS - OPERATE MODE	1-2
FIG. 1-3. DISPLAY SELECTOR FUNCTIONS - SET-UP MODE	1-3
FIG. 3-1. BOOM SECTION SWITCHES	3-2
FIG. 3-2. CHANGING APP. RATE 'ON THE GO'.	3-3
FIG. A 1. ARC FLOW CONTROL - WIRING DIAGRAM	A-2
FIG. A 2. ARC FLOW CONTROL - PLUMBING DIAGRAM	A-3
FIG. A 3. SERVICE FORM	A-4
FIG. B-1 ARC SYSTEM DATA FLOW	B-2
FIG. B-2. ARC 6000 CONSOLE	B-3
FIG. B-4. FLOW METER	B-4
FIG. B-3. GROUND SPEED RADAR	B-4
FIG. B-5. FLOW CONTROL VALVE	B-4
FIG. B-6. BOOM CONTROL SWITCHBOX	B-5

Revision Log

<u>Revision</u>	<u>Reason</u>	<u>SW Ver.</u>
97108	New Manual	1.31
98250	New Format	1.31
2	Updated Graphics & Format	1.31
3	Updated Graphics & Format	1.31

This page left blank intentionally

HOW TO USE THIS MANUAL

This manual is designed to provide you with the basic information needed to set up and operate the MID-TECH® Automatic Rate Control (ARC) spraying system. Actual procedures may vary somewhat, depending on the configuration of your system.

When you see "Mitch", he is pointing out special information that you should be aware of, regarding safety, preventing console damage, an easier way to perform an operation, etc..



Below is a listing of the chapters in this manual, along with a brief description of the information found in each chapter.

Chapter 1 - Switches and Controls - Lists each control switch, on the face of the console, and gives a brief description of its use.

Chapter 2 - Calibration and Setup - Takes you, step by step, through the calibration of each sensor providing input to the console, and the entering of other information the console needs to perform the functions you require.

Chapter 3 - Operation - Briefly describes how to initiate the spraying operation.

Chapter 4 - Trouble shooting - Lists possible causes and remedies for the error codes that appear on the ARC display if the console detects a problem.

Chapter 5 - Maintenance - Describes the basic maintenance needed to keep your system operating at peak performance.

Chapter 6 - Emergency Operations - Suggests ways to operate, under reduced accuracy, in the event of a major fault.

Appendix A - Sample system wiring and plumbing diagrams.

Appendix B - System Overview - Describes the major components of the ARC system and their individual functions in application control.

Appendix C - Glossary/Tables

Back Cover - Quick Start/Quick Set Up Guides

This page left blank intentionally

Chapter 1 Switches and Controls

This chapter shows the location of each switch and indicator found on the ARC control console and discusses its function in both the Operate and Setup modes. (Further information can be found on pages shown in parenthesis.)

Console Switches and Indicators

POWER SWITCH

The Power switch (See #1 in Fig. 1-1) controls the power to the console. Always turn the Power switch “OFF” when not in use. This protects against accidental operation of the control system and unnecessary current drain on the vehicle battery.

Don’t worry about the console losing the set-up information with the power turned off. The ARC Control Console has a nonvolatile memory that doesn’t require constant power to hold it’s information.

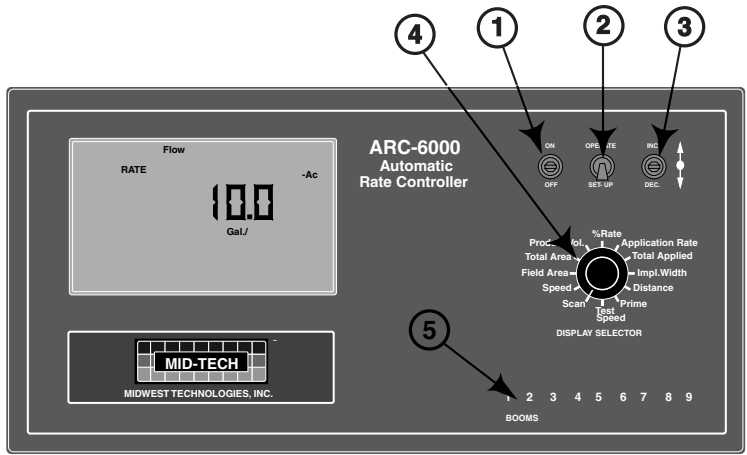

Fig. 1-1. ARC Console - Switches and Indicators

MODE SELECTOR SWITCH

The Mode Selector switch (See #2 in Fig. 1-1) is used to switch between the OPERATE and SETUP modes of the Control Console. When applying product, this switch must be in the “OPERATE” position. The “SET-UP” position is used for entering information into the console. In the SETUP Mode an “Errr” message appears if a position is selected which can not be programmed.

INC / DEC SWITCH

The Increase/Decrease (INC/DEC) switch (See #3 in Fig. 1-1) is used, in both the OPERATE and SETUP modes, to change the values appearing in the display.

Boom Section “ON/OFF” Indicators

The boom section On/Off indicators (See #5 in Fig. 1-1.) indicate which boom sections are selected by the operator. When a boom is been selected, its indicator lamp is lit. Boom section number 1 is usually the one to the left of the sprayer. There are a maximum of nine boom sections available.

Display Selector Switch

The Display Selector (See #4, Fig. 1-1) is used to choose which of the various console functions is to be displayed on the screen and available for adjustment by the operator.

Display Selector Functions - Operate Mode

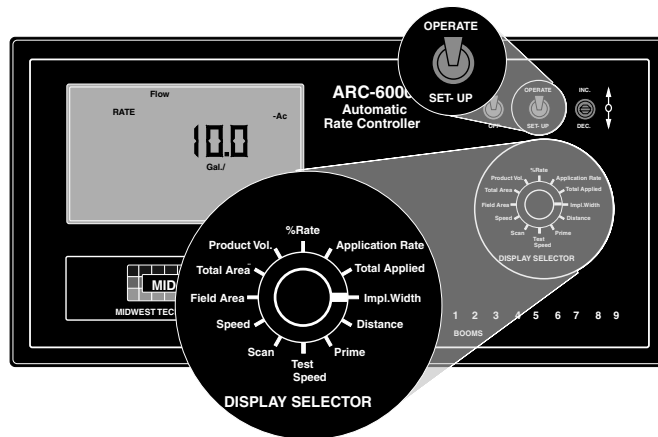

Speed: The current vehicle speed.

Field Area: Accumulated Area. (Pg. 3-1)*

Total Area: Accumulated Area. (Pg. 3-1)*

Product Vol: Amount of product aboard the sprayer. (Pg. 2-14)**

Fig. 1-2. Display Selector Functions - Operate Mode

% Rate: The percent by which the programmed application rate, at which the product is being applied, is changed with each activation of the INC/DEC switch. (Pg. 2-3)***

Application Rate: The desired application rate. (Pg. 2-2)** Once application has started, and metered discharge is established, the actual measured application rate is displayed here. (Also used to set the control valve to manual control.) (Pg. 6-4)

Total Applied: The total volume of product applied, as measured by the flow meter.*

Impl. Width: The active boom width, (Total width of all boom sections turned “ON”).

Distance: The accumulated distance.

Prime: This position is used to lock the control valve open during product pump priming. (Pg. 3-4)

Test Speed: The speed the console uses for stationary tests of the sprayer. (Pg. 2-12)**

Scan: The display scans SPEED, FIELD AREA, PRODUCT VOLUME, APPLICATION RATE, and TOTAL APPLIED, holding at each position for approximately two seconds before automatically cycling to the next.

* Totals can be reset in this mode.
 ** Values are programmable in this mode.
 *** Values changeable by a % increase or decrease.

Display Selector Functions - Setup Mode

Speed: Ground Speed Override (GSO) Value. (Pg. 2-13)**

Field Area: Select area alarm. The display flashes and the console beeps each time a selected increment is reached. The display reacts for about three seconds and then stops until the next increment is reached. (Set to zero to disable.) (Pg. 2-14)**

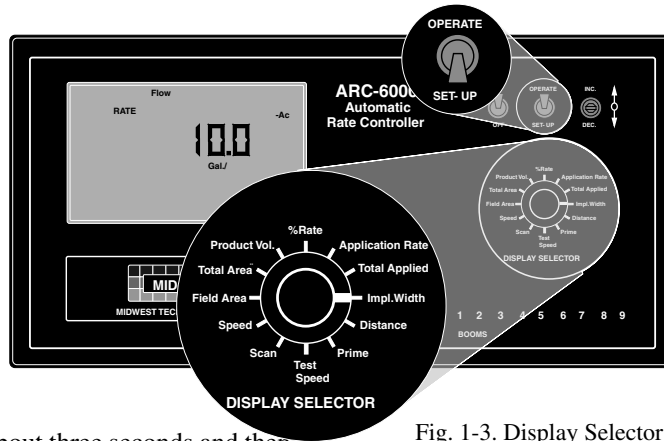

Fig. 1-3. Display Selector Functions - Set-Up Mode

Total Area: Err, No function in the SETUP mode.

Product Volume: Use the INC/DEC switch to set the full load value of the vehicle. (Pg. 2-14)**

% Rate: The percent by which the programmed application rate can be changed with each activation of the INC/DEC switch when application is underway. (Pg. 2-3)**

Application Rate: ERR, No function in SETUP mode.

Total Applied: This is the flow meter calibration number. (Pg. 2-8)**

Width: Individual boom section widths. The display cycles through the individual boom sections in order, unless a particular boom switch is activated and the boom master switch is ON. (Pg. 2-3)**

Distance: Distance Calibration Number. (Pg. 2-4)**

Prime: Reads Pump L STnrd - Cannot be changed.

Test Speed: The current Test Speed (Pg. 2-12).**

Status Switch

An external "Implement Status" input can be used to override the ARC control. The input must present a positive voltage (+12.0 VDC) on the green (or white) wire of the Boom Interface Cable. As long as this condition is present, the Control Console operates normally. If the voltage is interrupted, the Control Console automatically stops applying. At the same time, the Control Console will either "HOLD" or "CLOSE" the Control Valve, depending on the response selected by the operator. (See Page 2-11).

This feature allows the operator to control the operation of the control valve through the normal operation of the vehicle. The Status input can be used to sense the "ON"/"OFF" condition of the main vehicle pump switch, a separate Master Switch, or, an external switch monitoring an implement "UP"/"DOWN" condition.

* Totals can be reset in this mode.
** Values are programmable in this mode.
*** Values changeable by a % increase or decrease.

Ground Speed Override Switch

If your ARC system includes an optional MID-TECH® Boom Control Switch Box, the Ground Speed Override (GSO) switch is already installed. An optional, externally mounted, GSO switch can be used to temporarily operate the sprayer using a pre-selected, "GSO", minimum speed rather than the actual vehicle ground speed. The override feature is used to reach the application rate quickly when starting the vehicle from a complete stop or to maintain an adequate spray pattern when the vehicle is moving at very low ground speeds. It can also be used to allow the operator to flush or empty the tank from the cab, with the vehicle stopped.

The Control Console operates normally as long as the GSO switch condition is open (OFF). Whenever the switch is closed (ON) and the actual ground speed is less than the "GSO Speed", the Control Console automatically uses the "GSO Speed" value to control application rate. As soon as the switch reverts to its normally open (OFF) condition, or the actual ground speed increases above the preset "GSO Speed", the Control Console will adjust the application rate based on the actual ground speed.

CAUTION: Controlling application rates based on a "GSO Speed" is not as accurate as using the actual ground speed. When Ground Speed Override is being used and the true ground speed is less than the "Ground Speed Override" speed, the console sounds an alarm and the display flashes a "Too Slow" message to warn the operator of possible mis-application.

Fig. B-6, in Appendix B, shows a "Boom Control Switch Box" which incorporates the Implement Status Switch and the GSO function into one switch. The "OFF" position provides a Status Switch "OFF" condition, "AUTO" furnishes Status Switch ON, and "GSO" activates the GSO function. Other methods of controlling these functions are also available. This switchbox also includes an individual ON/OFF switch for each boom



This page left blank intentionally

Chapter 2 Calibration

NOTE: PLEASE READ THROUGH THE FOLLOWING SECTIONS COMPLETELY BEFORE YOU BEGIN CALIBRATION!



The Control Console must be calibrated and programmed with certain information before it can be used. First, the specific details of your applicator (i.e. Application Rates, Boom Widths, Test Speed, etc.) are entered. Next, the flowmeter and ground speed sensors are both calibrated. The calibration and set up procedures are not difficult, however, they must be followed precisely in order to get the maximum possible accuracy out of the system.

English, Metric, or Metrish Units

The Control Console is capable of displaying three different units of measure, US, Metric and Metrish. Metrish is the same as Metric, except area is measured in Acres.

UNITS FOR EACH DISPLAY SELECTOR SWITCH POSITION

POSITION	US	METRIC	METRISH
Speed	Miles/Hour (mph)	Kilometers/Hour (kph)	Kilometers/Hour (kph)
Field Area	Acres (acre)	Hectares (ha)	Acres (acre)
Total Area	Acres (acre)	Hectares (ha)	Acres (acre)
Product Vol.	US Gallons (gal.)	Liters (l)	Liters (l)
Appl. Rate US	Gallons/acre (gpa)	Liters/Hectare (l/ha)	Liters/Acre (l/acre)
Total Applied	US Gallons (gal.)	Liters (l)	Liters (l)
Impl. Width	Inches - Feet (in., ft.)	Meters (m)	Meters (m)
Distance	Feet - Miles (ft.-miles)*	Meters - Kilometers (m-km)*	Meters - Kilometers (m-km)*
Test Speed	Miles/Hour (mph)	Kilometers/Hour (kph)	Kilometers/Hour (kph)

* No units displayed after roll over of feet to miles or meters to kilometers

CHANGING UNITS

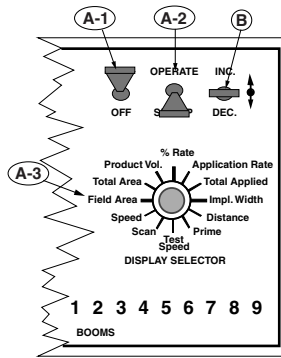

A. Set the console switches to the following positions:

- 1. Power "ON"
- 2. Mode Selector "OPERATE"
- 3. Display Selector "SPEED"

The display shows the current speed units.

B. Using the INC/DEC Switch, select the measuring system desired (See following chart). The INC/DEC Switch must be held for approximately 5 sec. before the change occurs.

Units	INC./DEC. Switch
English to Metric	"DOWN"
Metric to English	"DOWN"
English to Metrish	"UP"
Metrish to English	"DOWN"

NOTE: Metric to Metrish is not available. Change to English first and then to Metrish.

Setting the APPLICATION RATE to 0.0 will turn off the flow control function.

Setting Application Rates

The ARC 6000 system is designed to maintain a constant, pre-selected application rate. In order for the Control Console to do this, the operator must enter the desired application rate. To set the desired application rate:

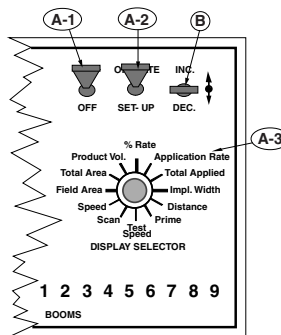

A. Set the console switches to the following positions:

- 1. Power "ON"
 - 2. Mode Selector "OPERATE"
 - 3. Display Selector "APPLICATION RATE"
- (Application Rate is set in the Operate Mode!!!)**

The display shows the current application rate.

B. Using the INC/DEC switch, set the desired rate.

Setting the % Rate Change

This feature allows the operator to change the application rate “ON THE GO” with a simple actuation of the INC/DEC switch. The amount of change each switch actuation makes is proportional to the value programmed into this position, (e.g. 20 =20% change in the target rate). For example, with the liquid application rate set to 10.0 gallons per acre, a single actuation of the INC switch causes the system to control flow at the rate of 12.0 gallons per acre (10.0 + 20% = 12.0). To set the desired % Rate Change value:

A. Set the console switches to the following positions:

- 1. Power “ON”
- 2. Mode Selector “SETUP”
- 3. Display Selector “% RATE”

The display shows the current % change value.

B. Using the INC/DEC switch, set this number to the desired % change value.

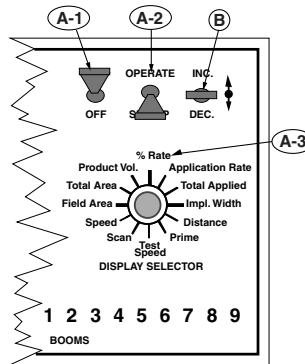

Setting Boom Widths

The MIDWEST TECHNOLOGIES Control Console is designed to automatically compensate for changes in the swath width, caused by turning boom sections on or off. To accurately respond to changes in swath width, the console must know the size of each boom section. To set the desired boom section widths:

A. Set the Console to the following positions;

- 1. Power “ON”
- 2. Mode Selector “SET- UP”
- 3. Display Selector “IMPL. WIDTH”

B. All Boom Switches (or Master Switch) “OFF”

The display cycles through each boom position (1 through 9) and displays its current width in inches.

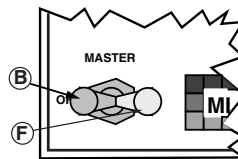
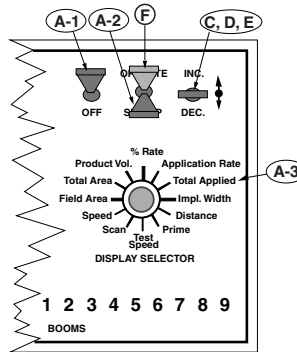

Boom widths are entered in inches in the US system. For example; for a liquid boom with 7 nozzles on 30" spacings, enter 210 for that boom. There is no need to convert to feet, the control console does that automatically when it is switched back to the Operate Mode. (In metric and metrish, all widths are entered in meters.)

- C. As each boom position appears on the display, use the INC/DEC Switch to set the display to the number of **inches** covered by that boom. Repeat for each section.
- D. Set all unused boom sections to a width of zero "0" inches. This insures that accidentally turning a boom switch "ON" doesn't affect the control console.
- E. Finally, let the boom width display cycle through the boom sections until it shows "Boom C". When the "C" width is displayed, set it to the normal operating width of the entire sprayer, **in inches**, using the INC/DEC switch.
- F. The boom width is now set. Turn all booms "ON" and return to the OPERATE Mode, the new total boom width will be displayed **in feet**. If this does not agree with your total applicator width, check the individual boom widths, (steps A, B and C).

RECORD THESE CALIBRATION NUMBERS ON LAST PAGE OF MANUAL.

Distance Calibration - Ground Speed Sensor

GENERAL CONSIDERATIONS AND INITIAL CALIBRATION NUMBERS

The Control Console must be calibrated to the ground speed sensor installed to ensure accurate application rates. The procedure involves physically measuring an accurate distance along a road or field, driving the vehicle through that distance, mathematically comparing the distance computed by the control console to the actual measured distance, and making any necessary adjustments to the distance calibration number. Follow the recommended procedure below to ensure accuracy of operation. Follow the recommended procedure below to ensure accuracy of operation.

The distance calibration should be checked periodically to maintain its accuracy. A calibration test is especially important if the sensor mounting has become loose or has been repositioned (Radar Sensor), or if the tires have been changed (Wheel and Speedometer Sensor).

Use the following initial calibration numbers.

MID-TECH® COMPACTRADAR - 780
DjRADAR - 1000
WHEEL SENSOR - 3500
SPEEDOMETER SENSOR - 3500

To view and adjust the speed calibration number:

A. Set the Control Console switches to the following settings:

- 1. Power "ON"
- 2. Mode Selector "SETUP"
- 3. Display Selector "DISTANCE"

The display shows the distance calibration value.

B. Use the INC/DEC switch to select the initial distance calibration number suggested. You can now perform the distance calibration procedure.

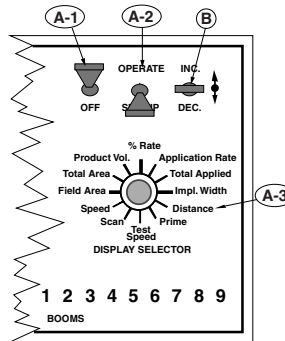

DISTANCE CALIBRATION PROCEDURE

The following procedure is recommended by MIDWEST TECHNOLOGIES for establishing an accurate distance calibration. **NOTE: All boom switches should remain "OFF" during the entire procedure.**

- A. Fill the vehicle 1/2 full of material (unless it is a pull type unit with the speed sensor mounted on the tow vehicle), to approximate actual load conditions. This minimizes the effect on the radar mounting angle or actual working diameter of the tires as the load empties.
- B. Measure a known distance of 400 ft. or more in a field or roadway (preferably in terrain similar to that being treated). Select an easy place in which to maneuver the vehicle. A longer distance, allows a more accurate test to be performed.
- C. Record the current Distance Cal. #.
 - 1. Turn the Display Selector to the "DISTANCE" position.

2. Set Mode Select switch to the "SET- UP" mode. The console displays the current Distance Calibration Number. Record this number for future reference. As an example, assume this number is 1000.

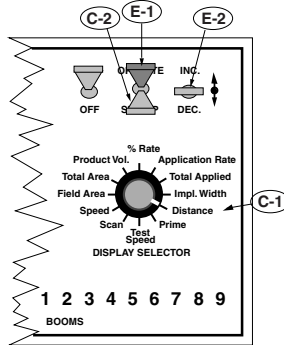

- D. Drive the vehicle to the starting point of the measured distance and stop.
- E. Zero out the Distance Accumulator
 1. Return the Mode Select switch to the "OPERATE" position.
 2. Reset the distance to zero using the DEC. switch.
- F. Drive the vehicle to the other end of the measured distance at a speed of between five and ten miles per hour. Distance measurements will accumulate on the display.
- G. Stop the vehicle at the measured distance end marker. Compare the indicated distance to the actual Measured distance, to determine how much correction is necessary. For example: if the indicated distance is 396 Ft. after driving over a 400 foot range, the error in the distance calibration is 1.0%.
- H. Calculate the new Distance Calibration Number using the following formula:

(Measured distance/Indicated distance) x Old DC# = New DC#

Example: $(400 / 396) \times 1000 = 1010$, the New DC#

NOTE: The same calibrations are used, regardless of the type of distance sensor .

- J. Enter the corrected Cal. #.

1. Select "SETUP" mode.
2. Use the "INC/DEC" switch to enter the new calibration number (See page 2-5).
3. Switch back to the "OPERATE" mode. The distance accumulator should now agree with the measured distance that you traveled. If it doesn't , recheck your calculations.

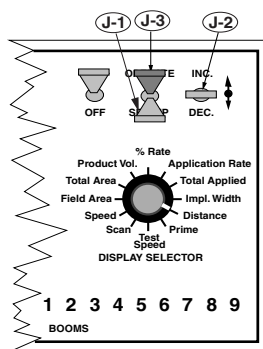

RECORD THIS CALIBRATION NUMBER ON LAST PAGE OF MANUAL.

Flow Meter Calibration

The Control Console requires calibration to the flow meter being used. Flow meters are calibrated at the factory, and this number is accurate enough for most applications, but actual flow characteristics may vary due to plumbing and/or chemical differences. If you have any doubts about the accuracy of the flow meter readings, perform a field calibration/catch test using the actual product solution. (see page 2-8)

DETERMINING THE INITIAL FLOW METER CALIBRATION NUMBER

The following table gives calibration numbers for flow meters commonly found in MID-TECH systems.

*** For Raven flow meters use the factory calibration number divided by 10. For all other flow meters-use the manufacturers' supplied information regarding the pulses per gallon.**

SIZE	SUPPLIER	CAL #	SIZE	SUPPLIER	CAL #
.75 Inch	MID-TECH	396.9	3.00 Inch	MID-TECH	5.0
1.00 Inch	MID-TECH	153.1	1.50 Inch	MID-TECH	38.8
1.25 Inch	Raven	75.0*	2.00 Inch	MID-TECH	23.8
3.00 Inch	Raven	16.4*			

Once the initial calibration number is entered into the console, proceed to the next section to “fine tune” the flow meter for maximum accuracy.

Use the following procedure to enter the flow sensor calibration number.

A. Set the Console to the following positions;

1. Power “ON”
2. Mode Selector “SET-UP”
3. Display Selector “TOTAL APPLIED”

B. Booms or Master Switch “OFF”

C. Use the INC/DEC switch to set the desired flow sensor calibration number.

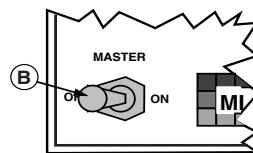
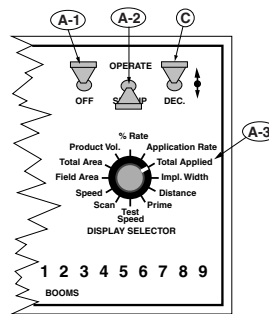

FINE TUNING THE FLOW METER CALIBRATION NUMBER

Once the initial calibration number is determined and entered into the console, run a calibration test to adjust the number for maximum accuracy. The accuracy of this test improves with the increase of both the volume of material discharged and the accuracy of measuring that volume. Volume of liquid discharged can be measured using a second, calibrated flow meter, using a truck scale and calculating volumes based on weight and density of the liquid discharged, or by discharging into a marked, calibrated tank.

It is necessary to pump and measure at least 100 gallons and, preferably, as much as 300 gallons, depending on the accuracy required.

A stationary test like the following is recommended.

- A. Disconnect the line leading from one of the boom valves to its boom, at the boom, and direct the output to an appropriate catch basin.

- B. Condition the console.
 1. Verify that the Boom Switches (or Master Switch) are "OFF".
 2. Turn the Control Console "ON".
 3. Select the "SETUP" mode.
 4. Rotate the display selector to "TOTAL APPLIED".

- C. The current flow meter calibration number is displayed. Verify that it is the recommended initial calibration number for the flow meter installed in the system. Use the INC/DEC switch to adjust as necessary.

- D. Reset the Total Applied Accumulator to zero.
 1. Select "OPERATE" with the Mode Selector Switch.
 2. Turn the Display Selector to "TOTAL APPLIED"
 3. Hold the DEC switch down for three to five seconds to reset the accumulated gallons to zero.

- E. Make sure there is enough liquid in the main tank to do the test. Start the main carrier pump.

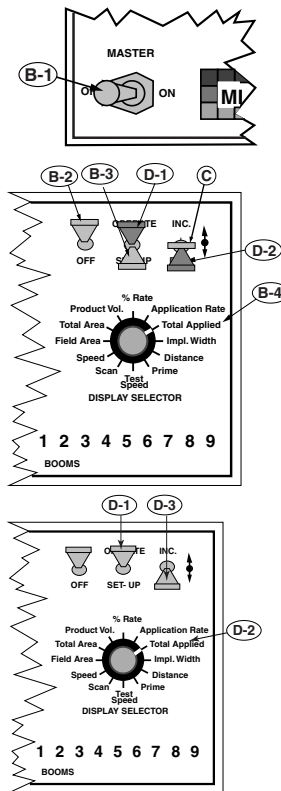

F. Generate a speed input to the console.

1. Set the GSO Speed.
 - a) Turn the Display Selector to "Speed".
 - b) Select 'SETUP' mode.
 - c) Use the INC/DEC Switch to set a 10 MPH GSO speed.
 - d) Switch back to "OPERATE" mode.

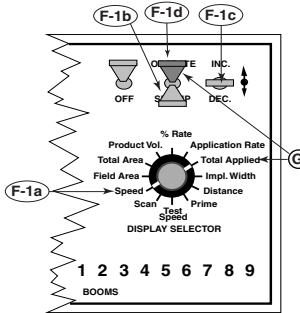

2. Turn on the Boom Switch for the selected boom (Make sure the Master Switch is turned on). Allow the sprayer to discharge until the desired amount has been pumped.

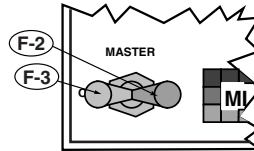

3. Turn "OFF" the Boom.

G. Select "TOTAL APPLIED" and "OPERATE". If the total shown on the console agrees with the total discharge actually measured, no further action is necessary. The flow meter is already calibrated.

H. If the indicated volume pumped does not agree with the actual volume pumped, calculate a new calibration # as follows:

$$\text{New Cal. \#} = (\text{INDICATED AMOUNT} / \text{MEASURED AMOUNT}) \times \text{Old Cal. \#}$$

- If the measured amount is more than the indicated amount, the new Cal. # is smaller.
- If the measured amount is less than the indicated amount, the new Cal. # is larger.

I. Enter the correct Cal. # per steps B and C on page 8.

RECORD THIS CALIBRATION NUMBER ON LAST PAGE OF MANUAL.

An alternate method, of correcting the cal. #, at this point, is to:

- A. Switch back and forth, between: "OPERATE/TOTAL APPLIED" and "SETUP/TOTAL APPLIED"
- B. Using the INC/DEC Switch, change the cal # until the Total Applied display equals the amount actually dispensed. The cal. #, at this point, is the corrected number.

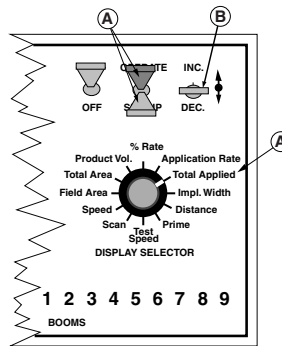

- C. Write this number down for future reference. This is the number to use for these specific conditions (product and applicator configuration).

Fine tuning of the calibration number can also be done based on field experience. If liquid is consistently left over after applying on a known number of acres, adjust the calibration number up slightly. If there is consistently too little material to cover the desired acres, adjust the calibration number down slightly.

Setting The HOLD/CLOSE Response

The operator can select either a "HOLD" or "CLOSE" response of the Flow Control Valve to both the Implement Status Switch and to an "All Booms OFF" condition. These responses are independent of each other, allowing the operator to select a "HOLD" condition for one and a "CLOSE" for the other. Careful consideration should be given to both conditions and the response selected for your application.

IMPLEMENT STATUS SWITCH

When the "HOLD" condition is selected, opening the Implement Status Switch causes the Flow Control Valve to hold in its current position. When the Implement Status Switch is closed the Flow Control Valve is already open and product flow is instantaneous. This response assumes that some other device, such as a boom section valve, has stopped the product flow.

When the "CLOSE" condition is selected, opening the Implement Status Switch automatically causes the Flow Control Valve to close. This response is preferred when it is necessary to use the Flow Control Valve to stop the product flow.

Use the following procedure to set the Status Switch response.

- A. Set the Console to the following positions;

1. Power "ON"
2. Mode Selector "OPERATE"
3. Display Selector "TOTAL APPLIED"

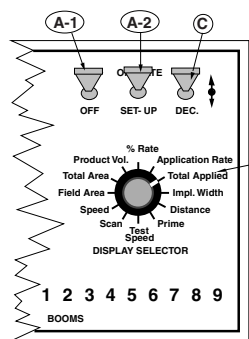

B. All Booms (or Master Switch) "OFF"

C. Hold the INC/DEC switch up to display the current setting. Continuing to hold the INC Switch up causes the display to cycle between the two options at about three to ten second intervals. The option appearing in the display when the INC Switch is released is the response selected.

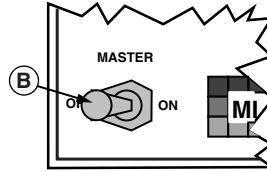

All Booms Off

When the "HOLD" condition is selected, an "All Booms OFF" condition causes the Flow Control Valve to hold its current position. When the booms are turned "ON" again the Flow Control Valve is already open and product flow is instantaneous.

When the "CLOSE" condition is selected, an "All Booms OFF" condition (all Boom Switches "OFF" or Master Switch "OFF") automatically causes the Flow Control Valve to CLOSE. This response is used when the Flow Control Valve is used to stop the product flow.

Use the following procedure to set the All Booms Off response.

A. Set the Console to the following positions;

- 1. Power "ON"
- 2. Mode Selector "OPERATE"
- 3. Display Selector "IMPL. WIDTH"

B. All Booms (or Master Switch) "OFF"

C. Hold the INC/DEC switch up to display the current setting. Continuing to hold the switch up causes the display to cycle between the two options at about three to ten second intervals. The option appearing in the display when the INC Switch is released is the response selected.

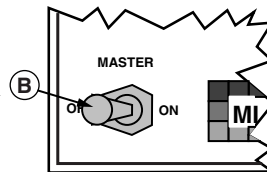
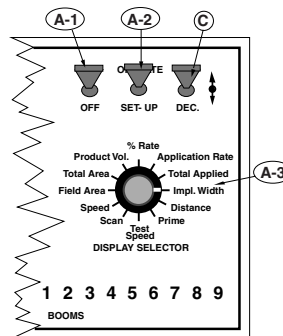

Setting the Test Speed Value

The Test Speed function is used to provide a speed input for stationary testing of the sprayer. Use the following procedure to set the Test Speed.

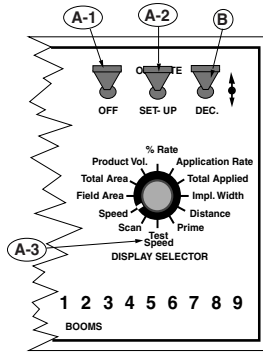

A. Set the Console to the following positions;

1. Power "ON"
2. Mode Selector "SETUP"
3. Display Selector "TEST SPEED"

B. Use the INC/DEC switch to Set the Test Speed to the desired value.

Rotating the Display Selector to the Test Speed position causes the console to substitute the selected Test Speed value for the Speed Sensor input.

Setting the Ground Speed Override (GSO) Value

To use the GSO feature, set the GSO value to the minimum ground speed you want to control to when the GSO Switch is activated. This should be the lowest speed at which the sprayer can operate smoothly and provide a good spray pattern. If you do not intend to use this feature, set this value to zero (0.0).

Use the following procedure to set the GSO Speed.

A. Set the Console to the following positions;

1. Power "ON"
2. Mode Selector "SETUP"
3. Display Selector "SPEED"

B. Use the INC/DEC switch to Set the GSO Speed to the desired value.

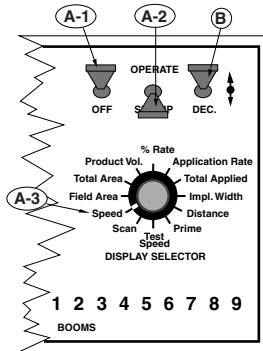

CAUTION: When traveling at a speed slower than the GSO speed setting, this feature will cause the Product to be applied at a Rate consistent with the GSO speed, rather than the true ground speed, possibly resulting in serious over application. When Ground Speed Override is being used, and the true ground speed is less than the pre-selected "GSO" Speed, the console will sound an alarm and the display will flash a "Too Slow" message to warn the operator of possible over application.

Setting the Field Area Alarm

The field area alarm alerts the operator, by flashing and beeping, as selected area amounts accumulate.

The operator can use this feature as a reminder to check the load to verify that it is being dispensed at the correct rate. This feature can also be used by the operator to verify acreage estimates.

A. Set the Console to the following switch settings:

1. Power "ON"
2. Mode Selector "SETUP"
3. Display Selector "FIELD AREA"

B. All Booms (or Master Switch) "OFF"

The display now shows the current selected acreage increments.

C. Use the INC/DEC switch to set the desired increments.

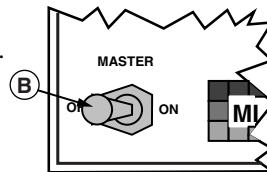
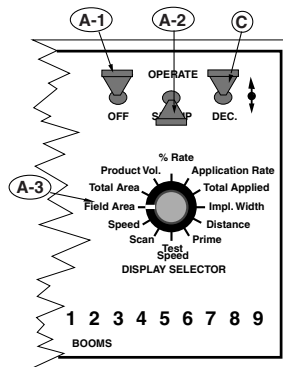

Product Volume (Full Load Value)

SETTING THE FULL LOAD VALUE

The Full Load Value of the vehicle can be preset into the console and automatically recalled when the vehicle is reloaded.

A. Set the Console to the following switch settings:

1. Power "ON"
2. Mode Selector "SETUP"
3. Display Selector "PRODUCT VOL."

B. All booms (or Master Switch) "OFF"

The display shows the current Full Load Value.

C. Use the INC/DEC switch to set the desired Full Load Value.

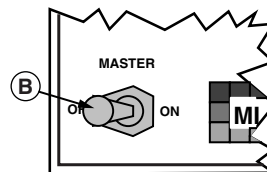
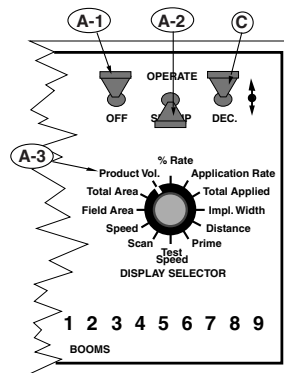

RECALLING THE FULL LOAD VALUE

When PRODUCT VOL. and OPERATE mode are selected, the Full Load Value of the vehicle can be recalled by holding the INC switch up for at least three seconds.

SETTING A LOAD VALUE LESS THAN FULL LOAD

If a full load is not taken aboard the vehicle, the actual amount loaded can be set without changing the "Full Load Value". First recall the Full Load Value as explained in the previous section, then use the INC/DEC Switch to set the actual volume loaded into the tank.

LOW PRODUCT ALARM

The Low Product Alarm alerts the operator when the Product Volume, displayed on the console, reads 10% of the Full Load Capacity. The console beeps for three seconds and displays the message "LO PROD". Console control functions are not affected by this alarm. To disable the alarm, do not recall the Full Load Capacity.

Chapter 3 Operation

Normal Start-up and Operation

It is important to verify that the control console is set up properly before beginning operations each day. Refer to Chapter 2 to review the detailed setup procedures.

- A. **CONSTANTS:** With all booms turned “OFF”, verify that the proper distance, flow meter, and boom width constants are still entered in the console. It is a good idea to write the constants down in a convenient location like the space provided on last page of the manual.
- B. **APPLICATION RATES:** With all booms turned “OFF”, the Mode Selector switch in the “OPERATE” position, and the Display Selector on APPLICATION RATE, check the current application rate setting.
- C. **ACCUMULATED AREA:** If desired, the accumulated acres can be reset to zero by selecting “FIELD AREA and/or TOTAL AREA” and holding the INC/DEC switch down until the display resets to zero. The area accumulators can be zeroed independently to track two separate areas. FIELD AREA can display up to 999.99 Ac., while TOTAL AREA can display up to 9999 Ac.
- D. **ACCUMULATED VOLUME:** Accumulated volume can be reset to zero by selecting “TOTAL APPLIED” while in the OPERATE Mode and holding down the DEC switch to reset. PRODUCT VOL. (the count down register) can be set for the load aboard by using the procedures on page 2-14.
- E. The control system is now ready to begin automated application. Set the Mode Selector switch to the “OPERATE” position. Select an appropriate display using the Display Selector, “SCAN” for example.

- F. Start the vehicle engine and make sure the pumps and/or hydraulics are fully engaged.
- G. As you reach the starting point of the first swath, turn “ON” the desired Boom Switches and the Master Switch. The ARC starts controlling application. If an “AREA” position is selected on the Display Selector, the acre accumulator begins to register.
- H. When you reach the end of the swath, turn “OFF” the Boom Switches, or Master Switch, to stop application. When the vehicle has been turned and is ready to start applying for the next swath, turn the Booms back “ON” and controlled application will start again.

Changing Active Boom Sections

The active boom sections can be changed at any time by turning the appropriate Boom Switches, similar to those seen at the top of Fig. 3-1, “ON” or “OFF”. The control system, automatically adjusts the flow rate as individual boom sections are activated or deactivated. When the Master Switch (or all the Boom Section switches) is turned “OFF”, the application stops. This allows the operator to select active boom sections “ON THE GO”, while depending on the control system to apply the proper rate on the area being covered.

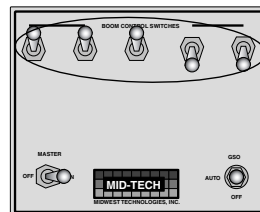

Fig. 3-1. Boom Section Switches

Changing Application Rate

We will use an example to illustrate the ability to change the application rate “on the go”.

Before starting the spraying operation, the operator sets the desired application rate into the control console using the procedure described in Chapter 2 of this manual. Anticipating the need to increase or decrease the application rate, the operator establishes a “% Rate Change” value using the procedure also described in Chapter 2 of the manual. For example, assume the control console has been set to apply 10.0 gallons per acre and the % Rate Change set at 20%

During normal spraying, the control console maintains the application rate at 10.0 gallons per acre. However, let's suppose the operator is spraying an aqueous fertilizer. A soil type change in the middle of the field requires a 40% higher application rate in order to reach desired fertility levels. As the sprayer crosses into the new soil type, the operator selects "% RATE" with the Display Selector. The display shows the percent of the programmed application rate currently being applied, in this case 100%. Pushing the INC/DEC switch up twice increases the application rate by 2 X 20% or 40%. The display shows 140%. The flow control valve opens until the flowmeter measures 14.0 gallons per acre. None of the other control functions of the console are affected.

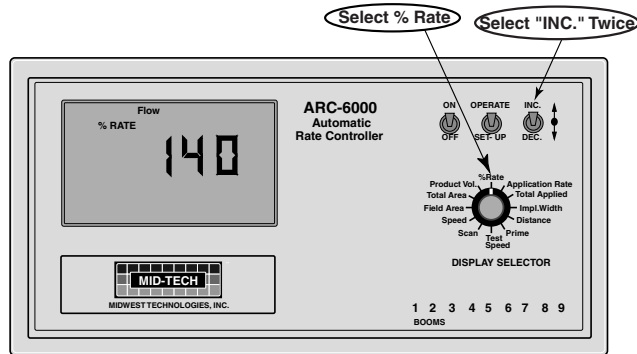

Fig. 3-2. Changing App. Rate "On The Go".

The new application rate is maintained until a further movement of the INC/DEC switch commands additional change, or a different position is selected with the Display Selector. When the Display Selector is turned to any other position, the control console resumes the 100% target rate established previously. The "% RATE" setting remains at the last value so the operator can switch back to the previous rate by just re-selecting the "% RATE" position. There is an approximate two second delay in initial valve response after the operator has switched to "% RATE" so the rates don't change by mistake as the Display Selector is turned through "% RATE" to another position.

Operation at a changed application rate is not a normal condition. The control console controls at the changed rate only as long as the Display Selector is turned to "% RATE".

Priming the Main Pump and Boom

Use the following procedure to “PRIME” the main pump and boom lines prior to spraying.

A. Set the console switches to the following positions:

- 1. Power “ON”
- 2. Mode Selector “OPERATE”
- 3. Display Selector “PRIME”

B. A series of five dashes (- - - -) appears on the display.

C. Hold the INC/DEC switch up for about three seconds. The main control valve moves to full open. While operating in this mode, there is no accumulation of area, distance or carrier volume.

D. The main pump can be run, with the booms or handgun open, to prime the sprayer. The control valve remains "OPEN".

E. Select any position, other than “PRIME”, with the Display Selector Switch to return the ARC System to normal spraying.

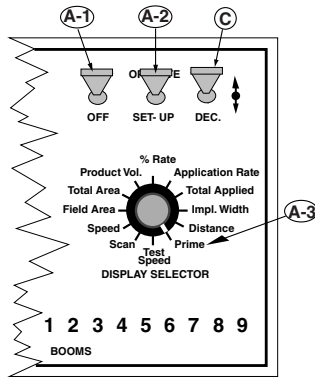

Ground Speed Override

An optional Ground Speed Override (GSO) Switch can be added to allow temporary operation using the "GSO Speed" instead of actual ground speed, (See page 2-12). The GSO feature is used to start spraying quickly when starting from a complete stop or to maintain a good spray pattern when the vehicle is being operated at very low ground speeds.

The ARC operates normally when the Ground Speed Override Switch is in the "OFF" (open) condition. **(If you do not have a GSO Switch, the shorting connector must be in place in the Boom Interface cable connector labeled “GSO”.** This feature can then be disabled by setting the GSO speed to zero.)

When the GSO Switch is "ON" (closed), and the actual ground speed is less than the "GSO Speed", the ARC automatically uses the "GSO Speed" value to control the application rate. If the actual ground speed increases above the preset "GSO Speed", the control console will revert to controlling application rate on the basis of the actual ground speed.

Examples:

<u>GSO Switch</u>	<u>"GSO Speed"</u>	<u>Ground Speed</u>	<u>Speed controlled to</u>
"OFF"	5 mph	6 mph	6 mph
"OFF"	5 mph	4 mph	4 mph
"ON"	5 mph	6 mph	6 mph
"ON"	5 mph	4 mph	5 mph

CAUTION: When traveling at a speed slower than the GSO speed setting, this feature will cause the product to be applied at a rate consistent with the GSO speed, rather than the true ground speed. Caution must be exercised when operating in this mode as serious over application can occur, if not used properly.



This page left blank intentionally

Chapter 4 Maintenance

MID-TECH recommends the following maintenance to keep your Control System operating at peak efficiency.

Flushing and Cleaning

Always follow carefully the chemical manufacturer's directions regarding cleaning and flushing.

As a general rule, MID-TECH recommends the following. Do not leave chemical or chemical solutions in the applicator overnight. The system should be cleaned at the end of each day's operation. This lessens the chance of chemicals "binding" to the walls of containers and hoses and being released later to contaminate later spraying operations.

WARNING: Failure to follow the chemical manufacturer's recommended cleaning and flushing procedures may result in chemical damage to crops receiving later treatment. All flushed material must be collected and disposed of in accordance with the applicable federal, state and local regulations in your area.



It is important to keep your chemical applicator clean. Chemicals are becoming more potent and environmental considerations are becoming more demanding. Keeping the equipment clean also makes it easier to maintain the vehicle and extends its working life.

Control Console

The Control Console requires no maintenance, other than checking the constants stored in memory and an occasional cleaning. The console can be kept clean by wiping with a damp cloth and by covering unused connectors with the attached dust covers. The constants can be monitored by checking each of the calibration numbers, and the desired application rate values (Refer to Chapter 2, Calibration.)

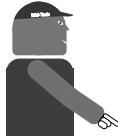

WARNING: Always disconnect all MID-TECH power cables, at the battery, when welding on the sprayer. Serious damage can result if left connected during these times.

Since the Control Console uses “nonvolatile memory” for storing the constants, it is unlikely that it will be necessary to reenter the calibration constants. However, constants have been known to be distorted as a result of electromagnetic interference. For this reason, MID-TECH strongly recommends recording the current calibration numbers in a convenient location and checking these values daily, before operating the sprayer. The last page of this manual provides space for recording the constants for your machine.

Ground Speed sensor

WHEEL SENSOR: Check the sensor frequently for loose or bent parts. Repair or replace any damaged parts immediately and recalibrate the sensor (Refer to page 2-5, Distance Calibration Procedure).

RADAR SENSOR: Check the sensor frequently to ensure that the face of the sensor is relatively clean (no dirt build up) and that the mounting bracket and hardware is tight and has not shifted in position. The sensor can be cleaned using a damp cloth. If it is suspected that the radar sensor mounting position has shifted, the mounting bracket must be tightened and the sensor recalibrated. (Refer to page 2-5, Distance Calibration Procedure)



WARNING: Follow all manufacturer’s safety instructions when working on and around the radar unit.

Flow Sensor

The flow sensor should be inspected periodically to ensure that there are no leaks around the fittings. At the end of the day, care should be taken to thoroughly flush the flow sensor with clean water. **ALWAYS VERIFY THAT WATER OR SEDIMENT IS NOT TRAPPED IN THE FLOW SENSOR, PARTICULARLY IN COLD WEATHER, AS DAMAGE TO THE MECHANISM MAY OCCUR.**

The impeller type flow meters supplied by MID-TECH are inherently rugged. However, continued use eventually wears the internal bearings and shafts causing the meter to be inaccurate. Replacement kits

are available to repair the meters. Contact your MID-TECH dealer for these parts.

Flow Control Valve

The flow control valve should be inspected to periodically to ensure there are no leaks around the attachment fittings. At the end of the day, care should be taken to thoroughly flush the flow control valve with clean water. **ALWAYS VERIFY THAT WATER OR SEDIMENT IS NOT TRAPPED IN THE FLOW CONTROL VALVE, PARTICULARLY IN COLD WEATHER, AS DAMAGE TO THE MECHANISM MAY OCCUR.**

Wiring Harness

Most failures of electronic systems, like the MID-TECH Control System, are the result of broken wires or poor connections.

Taking some time to periodically inspect and clean the wiring harness and connectors will help prevent these types of failures.

Inspect the external cabling for abrasion, and stretched or pinched wires. If such conditions are found, reroute the cabling and wrap it to protect it from further damage. If a broken wire is found, it can be temporarily repaired by stripping the wire back on each side of the break, twisting it together and soldering the connection' (Do not use acid core solder). The bare connection must be well insulated with heat shrink material or electrical tape.

The connectors at the ends of the cables must be periodically inspected and cleaned. Use a non-lubricating spray solvent (such as a tuner cleaner) to clean the connections. If the contact must be wiped clean, use a non abrasive swab (like a Q-TIP), along with the solvent, to avoid wear to the connector contact.

Sometimes connectors become damaged or worn out after many years of service. In this case, contact your MID-TECH supplier for a replacement connector kit.

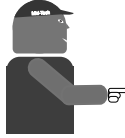

MID-TECH strongly recommends replacement of damaged cables as soon as possible. Once the cable insulation is damaged, moisture and chemicals can work their way under the insulation and cause corrosion of the conductor resulting in continued problems with the cable if it isn't replaced.

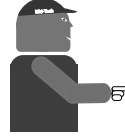

NOTICE: A Returned Material Authorization Number (RMA #) must be obtained from MID-TECH or your dealer for all items returned to MID-TECH for repair or replacement.

MID-TECH product(s) returned for repair or replacement must be cleaned and free of all chemical contamination before arriving at the MID-TECH facility.

Due to increasing OSHA requirements regarding the handling of chemically contaminated items, along with EPA restrictions regarding the disposal of chemical contaminants, MID-TECH technicians will not be allowed to handle, nor will we be able to dispose of the contaminants on returned item(s).

The chemically contaminated items will be returned to you without action taken by MID-TECH.

The items can then be returned to MID-TECH, using the existing RMA #, after a thorough cleaning.

Chapter 5 Trouble Shooting - Error Messages

Trouble shooting of the MIDWEST TECHNOLOGIES Control System begins when the Control Console senses a problem or inconsistency in the system. When this happens, the Control Console alerts the operator with a visual and audible alarm. The following chart presents the error messages that may appear on the display and possible causes and remedies.

ERROR CODE	CAUSE	REMEDY
Err 0	A required calibration number is set to zero.	Err 0/Pump L: reset flow meter Cal#. Err 0/Dist. Cal#: reset distance Cal#. Err 0/Boom #: reset boom widths (including boom width C).
Err 1 Pump L (TOO FAST)	Pump servo valve, or liquid flow control valve is fully open, or is no longer responding to an open signal, and the system cannot meet the rate called for.	Slow down, or check hydraulic flow to a hydraulically driven pump. Change to larger nozzles or slow down. Reduce sparging or increase pump output.
	Traveling too fast for desired application rate.	
	Nozzles are too small for rate and speed. (pressure will read HIGH).	
	Too much product being diverted to sparge.	

<p>Err 1 Pump L (Cont.)</p>	<p>Strainer or nozzle screens plugged.</p> <p>Pressure LOW, main strainer; Pressure HIGH, nozzle screens.</p>	<p>Clean screens.</p>
<p>Err 2</p>	<p>Not a diagnostic function in the ARC console.</p>	<p>Contact your MID-TECH dealer if you see this message on an ARC controller.</p>
<p>Err 3 Pump L</p>	<p>Console is not receiving pulses from the flow meter. Check for actual spraying at nozzles.</p> <p><u>No flow in the product line.</u></p> <p>Main supply tank is empty.</p> <p>Leak in main feed line.</p> <p>No output from product pump.</p> <p>Obstruction in main supply line.</p> <p>Main flow control valve not opening.</p>	<p>Refill tank.</p> <p>Check for ruptures or leaks at joints, fittings, etc.</p> <p>Turn product pump ON.</p> <p>Check for correct operation of hydraulic valves feeding the pump motor.</p> <p>Check for air lock in the product pump. Purge pump using the PRIME function.</p> <p>Check for blockage in product strainers.</p> <p>Check “Flow Control” connections on the back of the console. Secure if loose.</p> <p>Check in-line fuse (optional) near + battery connection. Check valve control signals.</p>

<p>Err 3 Pump L (Cont.)</p>	<p>Boom valves are not opening.</p>	<p>Check cables, from “Flow Control” port on back of console, to valve for bad connections, abrasions, and pinched or broken wires.</p>
		<p>Check for blown fuses</p>
		<p>Check cables, from “Boom Interface” port on back of console, to valves for bad connections, abrasions, and pinched or broken wires.</p>
	<p><u>Flow in the product line.</u></p>	<p>Check for blockage of the flow meter rotor.</p>
		<p>Check cables, from “Flow Control” port on back of console, to flowmeter for bad connections, abrasions, and pinched or broken wires.</p>
<p>Err 4</p>	<p>Not a diagnostic function in the ARC.</p>	<p>Contact your MID-TECH dealer if you see this message on an ARC controller.</p>
<p>Err 5 Pump L</p>	<p>Application rate is exceeding the target rate by 15%. Valve is not responding.</p>	<p>Check “Flow Control” connections on the back of the console. Secure if loose.</p>
		<p>Check in-line fuse (optional) near positive battery connection.</p>
		<p>Check valve control signals.</p>
		<p>Check cables, from “Flow Control” port on back of console, to valve, for bad connections, abrasions, and pinched or broken wires.</p>
<p>Err</p>	<p>Incorrect switch sequence is selected on the console.</p>	<p>Consult Chapter 2 for the correct switch sequence.</p>

<p>Err E</p>	<p>Memory error. This is often the result of a poor battery connection.</p>	<p>Hold down the decrease switch until the alarm stops. Check for any constants that may have been set to zero and re-enter the correct values. (See Chapter 2)</p>
<p>OFLO</p>	<p>Value to be displayed on console exceeds the maximum displayable size.</p>	<p>Hold down the decrease switch until the display re-sets to zero.</p>
<p>Err L</p>	<p>The vehicle electrical system voltage has fallen below about 10.0 VDC.</p>	<p>Establish good ground and battery connections. This is the most common fault when system is acting erratically.</p> <p>Check and service or replace the vehicle battery.</p> <p>Check and service or replace the vehicle alternator/voltage regulator.</p>
<p>Err C, n, hook (backward 7)</p>	<p>Internal Diagnostics.</p>	<p>A momentary appearance, followed by no other problems, can be safely ignored. If messages occur frequently during operation, or come on and stay on, contact your dealer for further assistance.</p>

Chapter 6 Emergency Operation

If the operator is experiencing a failure of the ground speed sensor, the main flow control valve or, the flowmeter, the first step is to carefully check the wiring harnesses for obvious problems and follow the suggested troubleshooting advice outlined in chapter 5.0 of this manual. Assuming there is no success in getting the failed component to respond, MID-TECH suggests the following procedures, as a **temporary measure**, until the component can be repaired or replaced.

If the operator chooses to follow one of the following procedures, he must realize that application accuracy is reduced. If this reduced accuracy is acceptable, these procedures will allow the operator to continue on a temporary basis.



Ground Speed Sensor Failure

The control console internally generates a speed signal when operated with the "GROUND SPEED OVERRIDE" (GSO) function activated. When the unit is operated in the GSO mode, the Control Console will establish the application rate as if the vehicle were actually moving across the field at the programmed GSO speed. This feature can be used to operate the sprayer, under reduced accuracy, in the event of a failure of the speed sensor.

- A. **Disconnect the speed sensor cable from the back of the ARC console.**
- B. With the vehicle stopped condition the console as follows:
 1. All Boom Switches (or Master Switch) "OFF"
 2. Power "ON"
 3. Mode Selector in the "SET UP" position
 4. Display Selector to the "SPEED" position
 5. Using the INC/DEC switch, set the GSO speed for the normal spraying speed, (See Page 3-5 for additional information).

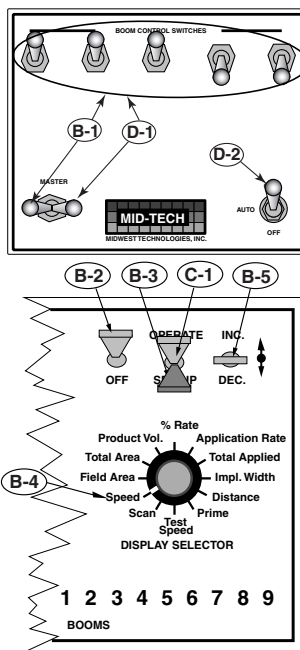

C. Position the sprayer

1. Set the Mode Selector switch back to “OPERATE”.
2. Drive toward the desired swath, accelerating to normal application speed (as close as possible to the GSO speed value).

D. Start Spraying

1. As the vehicle reaches the start of the desired swath, turn on booms and begin applying.
2. Ensure that the GSO Switch is ON if present.

E. The control console controls the application as if the vehicle is moving at the established GSO speed. The actual accuracy of application therefore depends upon the ability of the operator to maintain the desired vehicle speed. If the vehicle is traveling at exactly the established GSO speed, the application is nearly exact. If the vehicle is traveling faster or slower than the established GSO speed, the system will be over or under applying accordingly.

F. The console still records the Total Applied, and the system still adjusts to changes in boom width. These functions can be monitored on the display.

G. The ARC display flashes a **Too Slow** message, and an audible alarm sounds, to indicate abnormal operation. There is no speed displayed. Areas do not accumulate and displayed Application Rate information is meaningless.



MID-TECH recommends this procedure as a temporary, emergency procedure only. The problem should be resolved as soon as possible to allow full automatic control of the sprayer to be reestablished.

Flow control Valve Failure

The ARC System can be operated, at a reduced level of control, in the event of a flow control valve failure. To operate the sprayer, it is necessary to manually adjust the flow control valve so that sufficient pressure is available to the booms to give a good spray pattern. Thus, there is no longer positive control over the flow. Use the following procedure to manually position the flow control valve.

A. With the vehicle stopped

1. All boom sections “OFF”
2. Power “ON”
3. Mode Selector to “OPERATE”
4. Display Selector to “APPLICATION RATE”
5. Use the INC/DEC switch to set an application rate of 0.0.

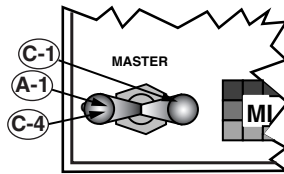

- B. Disconnect the flow control valve at the cable disconnect. If the valve has failed in a position allowing sufficient flow for a good spray pattern, no further valve adjustment is needed. If not, it will be necessary to remove the electric actuator assembly and manually rotate the valve stem to an open position. CAUTION: MARK THE VALVE POSITION BEFORE REMOVING ACTUATOR. FULL OPEN TO FULL CLOSE IS ONLY 90° OF ROTATION.**

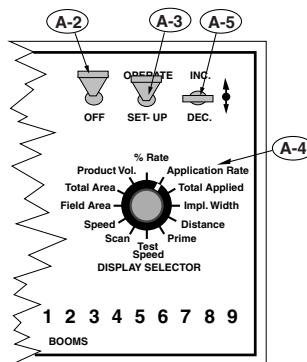

C. Adjust the Boom Pressure:

1. Turn “ON” the desired boom sections
2. Using a nozzle chart, determine the boom pressure that gives the desired application rate at the target speed.
3. Adjust the pump bypass valve (if one is provided) or manually turn the valve stem to generate the desired boom pressure.
4. Turn all boom sections “OFF”.

- D. Drive toward the swath to be sprayed. When the vehicle reaches the starting point of the desired swath, turn on the appropriate boom switches and the sprayer will start to spray. At this point, the operator is enjoying some monitoring functions of the ARC, but has no positive control of the flow control valve.**



- E. Monitor APPLICATION RATE. Actual application rate is displayed. Adjust the ground speed to maintain the desired rate.**

- F. The console cannot automatically adjust for changes in boom widths. If booms are shut off, pressure must be reset. Volumes and areas accumulate normally. Speed reads correctly.**

MID-TECH recommends this procedure as a temporary, emergency procedure only. The problem should be resolved as soon as possible to allow full automatic control of the sprayer to be reestablished.

Flowmeter Failure

This procedure is very similar to operating without the flow control valve except the flow control valve is controlled using a manual override procedure.

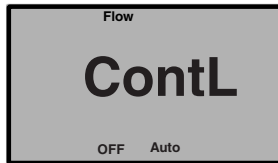
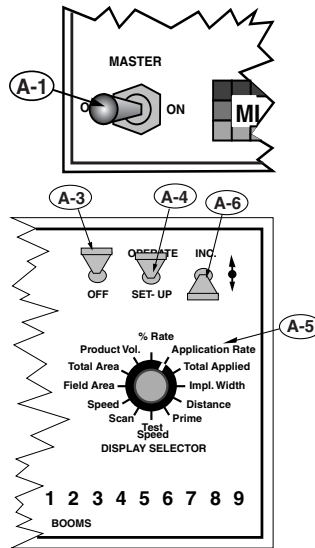

A. With the vehicle stopped:

1. Turn all boom sections "OFF".
2. Disconnect the flowmeter cable at the first connector back from the flowmeter (3 pin connector).
3. Turn the control console Power "ON"
4. Set the Mode Selector switch to "OPERATE"
5. Set the Display Selector to "APPLICATION RATE".
6. Using the DEC switch, set the display to 0.0. and continue to hold the DEC switch down for another 5 seconds until the display indicates "Flow Contl OFF Auto".

B. The flow control valve now responds only to manual commands from the INC/DEC switch on the control console. The control system remains in this mode until the control console power has been switched "OFF" and back on. **NOTE: When returning to automatic control, the application rate must be reentered.**

C. Adjust the Boom Pressure.

1. Turn "ON" the desired boom sections and allow spray.
2. Use a nozzle chart to determine the boom pressure that will give the desired application rate at the target speed.
3. Adjust the boom pressure using the INC/DEC switch on the control console. INC will open the flow control valve and DEC will close the valve.
4. Once the desired pressure is attained, turn all boom sections "OFF".

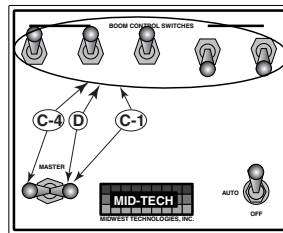

D. Drive toward the swath to be covered. When the vehicle reaches the starting point of the desired swath, turn on the appropriate boom switches and the sprayer will start to spray. At this point, the operator is enjoying some monitoring functions of the ARC, but has no automatic control of the flow control valve.

E. Monitor SPEED. Adjust the ground speed to reach the target speed desired.

F. The console cannot automatically adjust for changes in boom widths. If booms are shut off, pressure must be reset using the INC/DEC switch. Areas accumulate normally. Speed reads correctly.

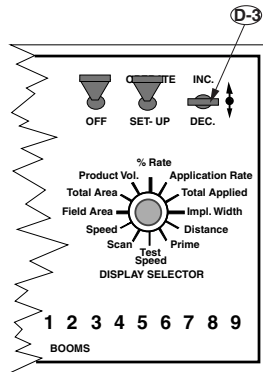

MID-TECH recommends this procedure as a temporary, emergency procedure only. The problem should be resolved as soon as possible to allow full automatic control of the sprayer to be reestablished.

This page left blank intentionally

Appendix A

System Diagrams

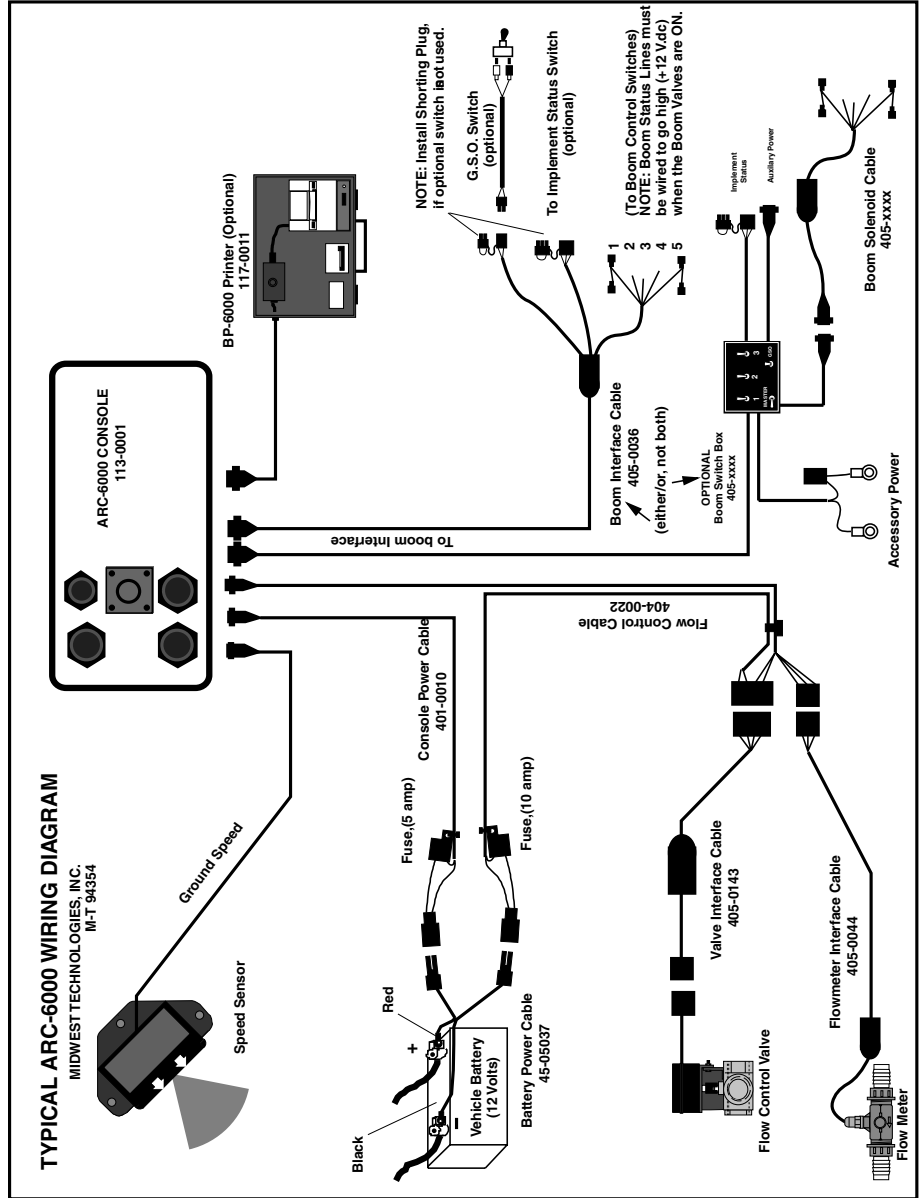

Fig. A 1. ARC Flow Control - Wiring Diagram

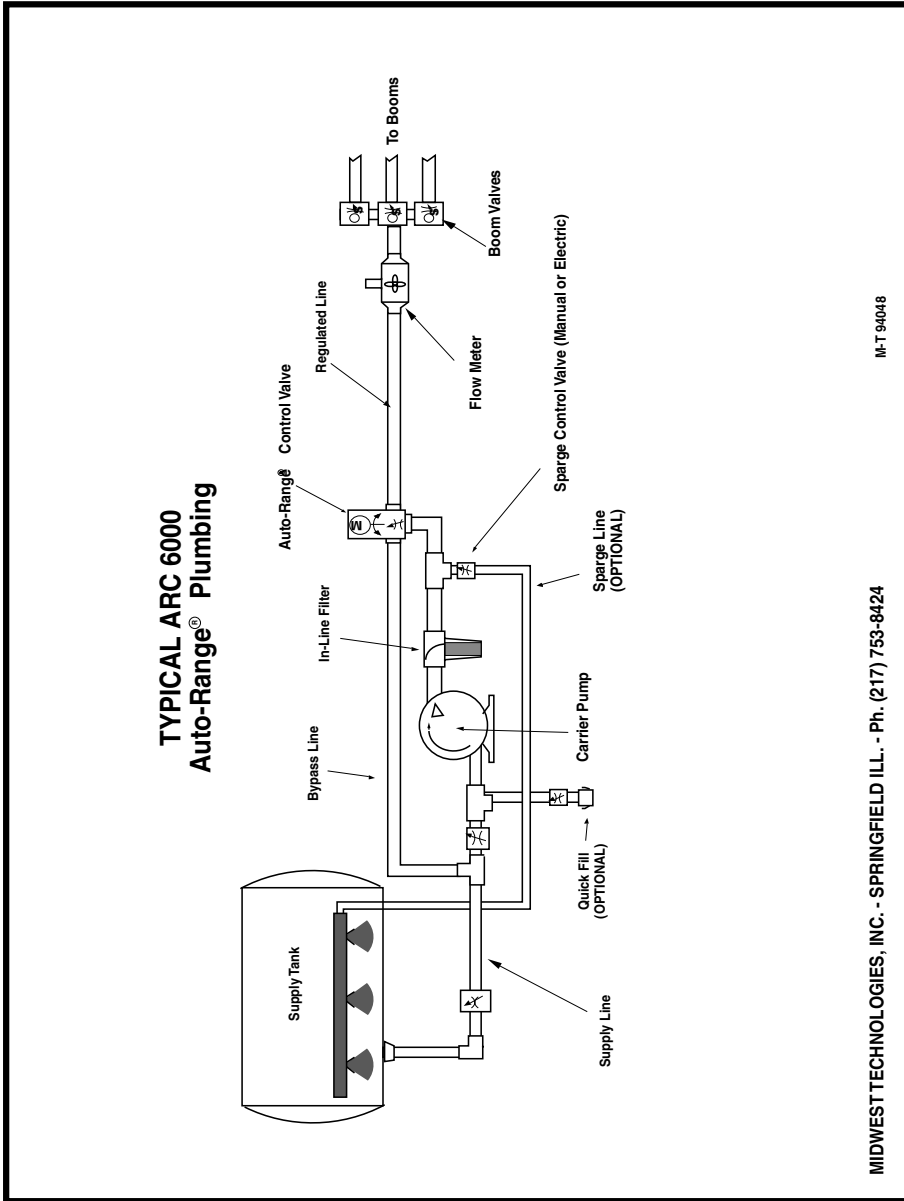

Fig. A 2. ARC Flow Control - Plumbing Diagram

**VALUES DISPLAYED BY ARC-6000
FILL OUT BEFORE CALLING FOR
FASTER SERVICE**

SOFTWARE VERSION: _____

Number displayed when console first powers up; e.g. 1.31

MODE SWITCH SETTING	OPERATE	SET-UP
FIELD AREA _____		
TOTAL AREA _____		
PRODUCT VOL. _____		
% RATE _____		
APPLICATION RATE _____		
TOTAL APPLIED _____		
IMPL. WIDTH _____		
DISTANCE _____		
PRIME _____		
TEST SPEED _____		
SCAN _____		
SPEED _____		

<p>ERROR MESSAGE DISPLAYED?</p> <p>_____</p> <p>_____</p> <p>OTHER INFORMATION?</p> <p>_____</p> <p>_____</p> <p>_____</p>

BOOM WIDTHS	C	
	1	
	2	
	3	
	4	
	5	
	6	
	7	
	8	
9		

Fig. A 3. Service Form

Appendix B

System Overview

Appendix B SYSTEM OVERVIEW

How The ARC Controls Application Rate

The ARC System compares ground speed, active boom width, and product flow rate four times a second. A change in ground speed or boom width results in a proportional change of material flow rate to maintain a constant, pre-selected application rate. High speed microprocessors and high resolution sensors are used in the ARC System to allow it to control the carrier application rate quickly and precisely.

ARC System Components

Each component is described below so the operator has a general understanding of function.

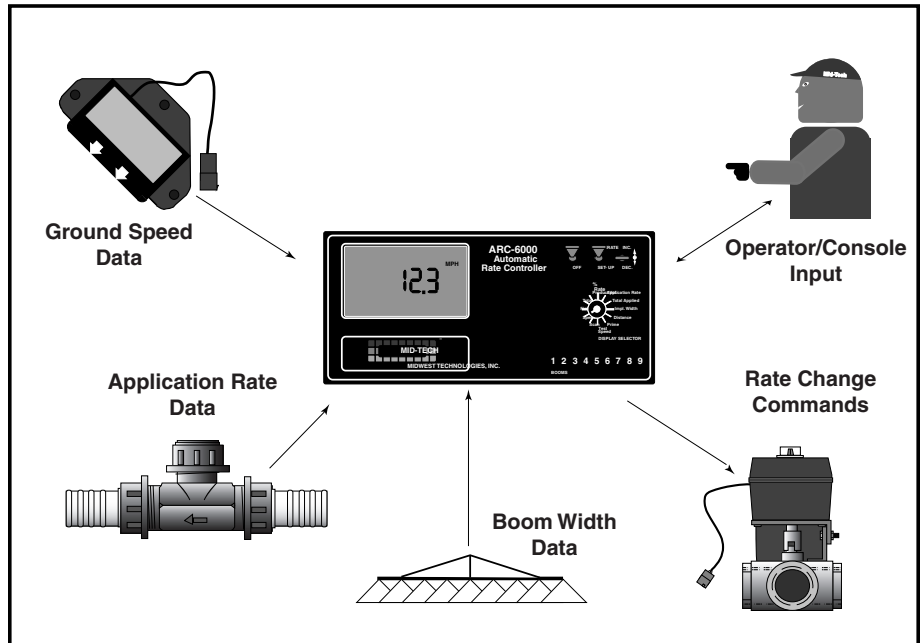

Fig. B-1 ARC System Data Flow

1. The ARC System Control Console

The ARC 6000 Control Console is the heart of the system and actually performs three separate functions.

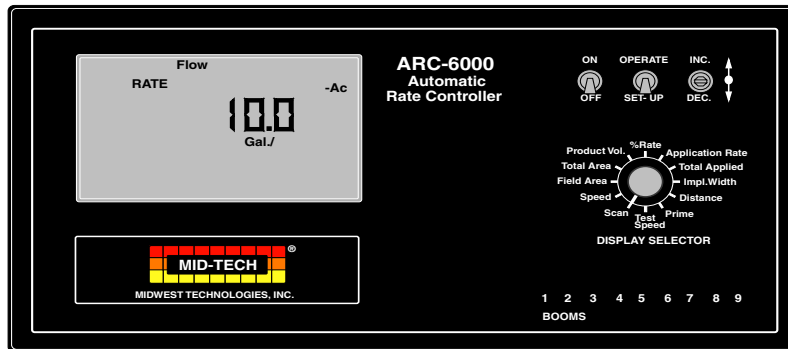

Fig. B-2. ARC 6000 Console

The console contains a small computer with a sophisticated control program developed by MIDWEST TECHNOLOGIES and continually monitors ground speed and active boom width. As these values change, the console immediately recalculates the required flow rate and makes any necessary corrections.

The ARC Console performs the second function of allowing the operator to command the entire system “ON THE GO” from the operator’s seat.

The third control console function is to keep the operator informed of the status of the applicator. The control console continually monitors the flow rate, vehicle ground speed and swath width, and immediately warns the operator, both visually and audibly, if the system can no longer maintain accurate application. The large, backlit liquid crystal display (LCD) gives instant readouts of application rate, volume applied, vehicle ground speed, active boom width, distance traveled, and the area covered while applying.

2. Ground Speed Sensor

The ARC requires an accurate ground speed sensor. A magnetic pickup, wheel sensor, mounted on a non-driven wheel, is very accurate and dependable for most spraying operations.

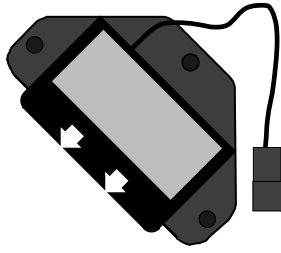

Fig. B-3. Ground Speed Radar

An optional radar ground speed sensor is available from MID-TECH for applications where wheel slippage and variations in ground conditions are a concern. The radar sensor does not depend on ground contact and is therefore unaffected by these problems.

Some applicators may already be equipped with a ground speed sensor. If the sensor meets the accuracy requirements of the ARC system, it can be adapted for use with the ARC console. Check with your MID-TECH® dealer, or the factory, regarding the adaptability of a specific sensor.

3. Flowmeter

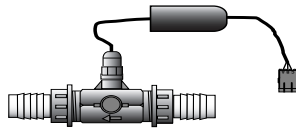

Fig. B-4. Flow Meter

Liquid ARC systems require a flow meter in the main boom feed line to measure flow rate and to determine when changes are needed in the position of the flow control valve. The flowmeter is an impeller device, meaning a specific volume of liquid flowing through the flowmeter rotates an impeller a specific number of revolutions. The ARC system can count the revolutions of the impeller very accurately, allowing the console to calculate the exact flow rate of the liquid in the applicator supply line.

Sometimes an applicator is already equipped with a flowmeter. Existing flowmeters can usually be adapted to work with the ARC System, as long as the flowmeter is placed to measure the total liquid flow to the booms. Check with your MID-TECH® dealer, or the factory, regarding the adaptability of a specific flowmeter. Note: Some flow meters may require a special adapter cable.

4. Flow Control Valve

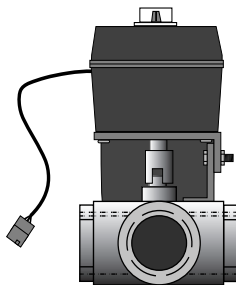

Fig. B-5. Flow Control Valve

ARC systems require a flow control valve to provide automatic rate control. The console uses this valve to control the chemical flow rate. To be effective in controlling flow, this valve must be both fast acting and precise in its movements.

The flow control valve may be a product valve, controlling the liquid flow directly, or it may be a hydraulic valve, controlling the speed of a hydraulic motor driving the liquid pump.

Sometimes an applicator is already equipped with an electronically controlled flow control valve. If the valve meets the speed and precision requirements of the ARC system, it can usually be adapted for use. Check with your MID-TECH® dealer, or the factory, about the adaptability of a specific valve.

5. Boom Interface

The ARC control console must know what boom sections are activated at any time, in order to adjust chemical flow rates appropriately. The console recognizes the status of as many as nine separate boom sections, by monitoring the control signal to each section. The console can also sense the operation of an Implement Status switch which would result in a selectable response by the flow control valve (position held or full closure). Finally, the system can be equipped with an optional Ground Speed Override switch which, when activated, will cause the control console, under certain conditions to use a pre-selected "OVERRIDE SPEED", rather than actual ground speed, to control the application rate.

The standard ARC system is supplied with a five position boom interface cable which plugs directly into the rear of the ARC console and allows connection of up to five boom control switches and one status switch. An optional nine boom interface cable is available for larger applicators.

An optional boom control switch box is available to serve those sprayers not already equipped with boom switches. Boom switch boxes are offered in three, five, or nine boom configurations and they are complete with wiring harnesses. The switch box also provides a MASTER ON/OFF boom switch, a GROUND SPEED OVERRIDE switch and acts as an interface for an IMPLEMENT STATUS switch. The wiring harness from the boom switch box plugs directly into the back of the ARC control console.

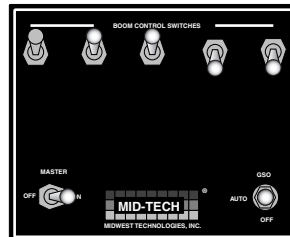

Fig. B-6. Boom Control Switchbox

This page left blank intentionally

Appendix C

Glossary/Tables

Glossary

The definitions in this glossary are worded to fit the needs of this manual only and may not apply to all sprayer operations in general.

AutoRange® Valve - A three port valve which controls both the main liquid flow and bypass flow.

Boom - An application width that is assigned a value and is used to calculate area.

Boom Section - A complete boom or part of a boom that can be turned on or off independent of other boom sections.

Bypass - The process of routing excess product pump output back to the low pressure side of the pump to control the amount of product available to the spray booms for application. This process is also used in hydraulic flow control also.

Carrier - A liquid or dry material that is used to convey herbicide, insecticide, fungicide, micronutrients, etc., to the ground.

Chemical Flow Monitor - A console mounted near the operator, which monitors up to six injection pumps, and initiates an alarm condition when the control system is calling for product from a certain injection pump but that pump's Chemical Flow Sensor detect no flow. This console is also used in some granular applications to monitor the product level in granular application bins.

Chemical Flow Sensor - Monitors the output of an injection pump and sends a signal to the Chemical Flow Monitor if there is no output from the pump.

Chemical Injection System - A system that includes a Control Console and a chemical injection pump. This system is designed to control chemical at a target rate, normally into a carrier.

Control Console - An operator console that constantly monitors all application conditions, such as speed, swath width, and current product flow rate, etc., and

sends the necessary control signals to the spray system to maintain the application rate at that designated by the operator.

Electromagnetic Interference - Externally generated electromagnetic fields, such as those from a high voltage transmission line, a vehicle alternator with a bad diode, sparkplugs, etc., which can disrupt the normal operation of an electronic device.

Flow Control System - A system that includes a Control Console, a rate sensor device, and a servo control. This system is designed to control product to a target rate.

Flowmeter - A device which measures volumetric liquid flow. MID-TECH uses two different basic types of flowmeter.

Standard Flowmeters - Each standard flowmeter has a standard range that it caaccurately measure. To change ranges requires changing flowmeters.

Rapid Check Flowmeters - Similar ro a standard flowmeter but has several different “inserts”, each with a different effective range, that can be installed. To change the range of the flowmeter just remove one insert and insert one having the desired flow range.

GSO - Ground Speed Override is a minimum application speed. When the vehicle speed drops below GSO, the Control Console controls the output to the GSO speed. Area is accumulated at the actual ground speed.

Hydraulic Servo Control Valve – The term used to describe a control valve that is capable of receiving and acting upon increase and decrease information from the Control Console and in turn controls the flow of hydraulic fluid.

Impeller - A metallic device, similar to a propeller, used in a flowmeter to monitor the liquid flow. Liquid flowing past the impeller causes it to turn. A magnet sensor, placed near the flowmeter wall, senses the impeller blades as they pass and generates pulses

to be sent to the control console.

Implement Status Switch - Provides a another means to stop the spraying operation. This switch may take the form of a foot switch or an implement switch mounted on the toolbar that opens a circuit as the tool bar is raised, effectively stopping the spraying operation..

Liquid Flow Control Valve – The term used to describe a control valve that is capable of receiving and acting upon increase and decrease information from the Control Console and in turn controls the flow of liquid product.

Master switch - A control switch that allows the operator to turn on and off all active boom switch one switch.

Product – Refers to the material that is to be metered and therefore controlled by the Control Console. This material can be grouped into the following categories:

Liquid – Includes, but is not limited to, liquid fertilizer, liquid fertilizer with chemical, water, water with chemical, liquid lime, deicing solutions, salt solutions, liquid manure, etc.

Chemical – Includes, but is not limited to, herbicide, liquid fertilizer, spray adjuvants, fungicides, insecticide, etc.

NH₃ – (Anhydrous Ammonia) A fertilizer material that is condensed from a gas to a liquid in order to be metered. Density of this material is entered into the equation in order for pounds of Nitrogen to be targeted and recorded.

Peristaltic Injection Pump - A pump in which a piece of tubing (see Pump Tube) inserted into the pump is squeezed between the inside wall of the pump and rollers attached to a rotating plate. Since the rollers are evenly spaced in the plate, the amount of material trapped between to the rollers is always consistant. By knowing how many revolutions the pump rotor has made, we can calculate quite

precisely the volume of liquid discharged by the pump.

Pump Control Module- An electronic module, located inside the injection pump enclosure, which controls the various pump functions as required by the main system control console.

Pump Tube - A length of tubing, usually Python or ED-Plex, used in a peristaltic type injection pump.

Returned Material Authorization Number (RMA) - A number obtained from MID-TECH or your dealer, which serves as your approval to return the item and informs MID-TECH of the circumstances of the return so that proper action (repair, replacement, credit, etc.) can be initiated quickly upon receipt of the item at MID-TECH.

Swath – A boom section or group of boom sections that should accumulate area and volume as a group. This term refers to a condition that is stored in the boom control module and utilized by the Control Console.

Sparge - The process of routing excess product pump output back to the product tank for agitation to keep dissolved products in suspension.

Valve Driver Module - An electronic circuit, usually enclosed in a “potted boot” attached to a cable. This unit acts as an interface between the console control signals and the actual drive signals to the valve.

USEFUL FORMULAS

$$\text{Noz. Press.} = \left[\frac{(\text{Rate} \times \text{Speed} \times \text{Noz. Spacing})}{(\text{GPM}_{40} \times 939.2)} \right]^2$$

Where: Rate = GPA
 Speed = MPH
 Noz. Spacing = Inches
 GPM₄₀ = Noz. Flow @ 40 PSI

$$\text{GSO}_{p. \text{ Min}} = \frac{[\text{GPM}_{40} \times 939.2 \times \sqrt{P_{\text{Min}}}]}{(\text{Noz. Spacing} \times \text{GPA})}$$

$$\text{Where: GSO}_{(10 \text{ PSI})} = \frac{(\text{GPM}_{40} \times 2970)}{(\text{Noz. Spacing} \times \text{Rate})}$$

$$\text{GSO}_{(15 \text{ PSI})} = \frac{(\text{GPM}_{40} \times 3637.5)}{(\text{Noz. Spacing} \times \text{Rate})}$$

GSO = Speed to Maintain a Min. Press (P_{Min})
 Rate = GPA
 Noz. Spacing = Inches
 GPM₄₀ = Noz. Flow @ 40 PSI

$$\text{Gal/MinBoom} = \frac{(\text{Rate} \times \text{Speed} \times \text{Boom Width})}{495}$$

Where: Rate = GPA
 Speed = MPH
 Boom Width = Ft.

$$\text{Gal/MinNoz} = \frac{(\text{Rate} \times \text{Speed} \times \text{Noz. Spacing})}{5940}$$

Where: Rate = GPA
 Speed = MPH
 Noz. Spacing = Inches

English/Metric Conversion**U.S. to Metric**

1 Acre = 0.405 Hectares
1 mile = 1.61 Kilometers
1 Foot = 0.305 Meters
1 Inch = 2.54 Centimeters
1 US Gallon = 3.785 Liters
1 Fluid Ounce = 29.57 Milliliters
1 pound = 0.454 Kilogram
1 Cubic Foot (ft³) = 0.028 Cubic Meters (M³)
1 Pound per Gallon = 119.68 Grams per Liter
1 US Gallon per Acre = 9.35 Liters per Hectare

Metric to U.S.

1 Hectare = 2.471 Acres
1 Kilometer = .62 Miles
1 Meter = 3.28 Feet
1 Centimeter = 0.394 Inches
1 Liter = 0.2642 Gallons
1 Milliliter = 0.034 - Fluid Ounces
1 Kilogram = 2.205 Pounds
1 Cubic Meter = 35.31 Cubic Feet
1 Kilogram per Liter = 8.36 Pounds per Gallon
1 Liter per Hectare = 0.107 Gallons per Acre



MID-TECH WARRANTY

MIDWEST TECHNOLOGIES ILLINOIS, LLC (herein called Mid-Tech) warrants to the original purchaser that the product purchased shall be free of defect in material or workmanship. If the product proves to be defective within the warranty period the purchaser must return, freight prepaid, said product to Mid-Tech within thirty (30) days after such defect is discovered. Upon inspection and examination by Mid-Tech, and at its option, Mid-Tech shall repair or replace, with a new or comparable product. No product will be considered defective if it substantially fulfills the performance specifications. Purchaser shall be responsible for all required maintenance service in accordance with procedures outlined in Mid-Tech's product operator manual or service bulletins.

All product(s) replaced or repaired under warranty shall carry the remainder of the warranty left on the original purchase. All out of warranty product(s) serviced for fee or goodwill will have ninety (90) days of warranty. The ninety (90) days shall begin on the date serviced by Mid-Tech.

Warranty periods for Mid-Tech products shall be:

Mid-Tech Legacy Consoles	–	2 ½ years
Mid-Tech TASC Consoles	–	2 ½ years
Mid-Tech ARC Consoles	–	2 ½ years
Mid-Tech AgLogix Consoles	–	2 ½ years
Mid-Tech Switch boxes	–	2 ½ years (3, 5, 9 boom)
All other Mid-Tech products	–	12 months (unless otherwise noted)

WARRANTY LIMITATIONS AND EXCLUSIONS

Mid-Tech will have no warranty obligation hereunder if the product is subjected to abuse, misuse, improper or abnormal usage, acts of God, faulty installation, improper maintenance as outlined in Mid-Tech's product operator manual or service bulletins. Consumable items (items that are used during normal operation) such as light bulbs, batteries, etc., and expendable items (items which wear out in normal use) such as injection pump tubes, flow meter bearings, etc., will not be covered by warranty. For products that come in direct contact with chemical, the specific recommendations contained in Mid-Tech product bulletins must be adhered to, or this warranty is void. Any repairs or alterations, other than those provided by Mid-Tech and/or its authorized representatives, will void the warranty. Mid-Tech neither assumes nor authorizes anyone to assume for it any other obligation or liability in connection with said product.

DISCLAIMER OF UNSTATED WARRANTY

The warranty printed above is the only warranty applicable to this purchase. Mid-Tech's warranty cannot be modified by any person or entity, including without limitation, any distributor or retailer of Mid-Tech. All other warranties, express or implied, including but not limited to, the implied warranties of merchantability and fitness for a particular purpose, are disclaimed.

LIMITATION OF LIABILITY

It is understood and agreed that Mid-Tech's liability, whether in contract, in tort, under any warranty, in negligence or otherwise, shall not exceed the return of the amount of the purchase price paid by purchaser and under no circumstances shall Mid-Tech be liable for special, indirect or consequential damages. In particular, Mid-Tech shall not be liable for damage to crops as the result of misuse or negligence in the application of chemicals or operation of Mid-Tech products. The price stated for the equipment is a consideration in limiting Mid-Tech's liability. No action, regardless of form, arising out of the transactions under this agreement may be brought by purchaser more than one year after the cause of action has occurred.

MIDWEST TECHNOLOGIES ILLINOIS, LLC

Specialists in Control System Electronics Since 1983



Contact your Mid-Tech dealer to see our complete line of accessories for your application

Corporate Office

2733 East Ash Street
Springfield, IL 62703
Phone: 217.753.8424
Fax: 217.753.8426

Sales and Service

www.mid-tech.com
1.800.MID.TECH
(1.800.643.8324)

Montana Office

90 West Central Avenue
Belgrade, MT 59714
Phone: 406.388.1993
Fax: 406.388.1883