

DYNAJET® IC7140

INSTALLATION / SETUP /
USER MANUAL



98-05347 R1

TeeJet
TECHNOLOGIES

A Subsidiary of  Spraying Systems Co.®

TABLE OF CONTENTS

CHAPTER 1 - INSTALLATION & UPDATING	6
DYNAJET IC7140 ECU	6
Software Updates	6
ECU Orientation.....	7
COMPONENT INSTALLATION	8
Installation System Components.....	8
Component Installation Instructions.....	9
Power Source.....	9
Drivers Modules and Terminators	9
Nozzle Harnesses	9
CAN Cables	9
Pressure Sensor.....	10
Boom Interface Module (BIM).....	10
SOFTWARE UPDATE INSTRUCTIONS	11
CHAPTER 2 - SCREEN INTRODUCTION	13
BASIC SCREEN USE	13
General Screen Options	13
How to Navigate Settings Options.....	14
Selecting from a List.....	14
Selecting a Numeric Value	15
CHAPTER 3 - INITIAL START-UP & CALIBRATIONS	16
NO. 1 POWER UP AND INITIALISATION	16
NO. 2 ESTABLISH SELECT SETTINGS	17
Enter Unlock Codes.....	17
Machine Setup.....	17
With Rate Controller Communications	17
No Rate Controller Communications	18
Setup and Select Nozzle	18
NO. 3 GET TO KNOW THE CONTROL MODES	19
NO. 4 PREFORM SYSTEM FUNCTIONAL TEST	20
Ensure Current Rate Control System is Operating Normally	20
Confirm Boom Sections are Functioning	20
Confirm Each of the Corresponding E-ChemSaver® Solenoids Is Pulsing.....	20
NO. 5 CALIBRATE THE RATE CONTROLLER REGULATION	20
Flow Pulses Tests	21
Test 1 – Duty Cycle 100%	21
Test 2 – Duty Cycle 50%	22
Test 3 – Duty Cycle “Minimum Duty Cycle”	22
NO. 6 CALIBRATE THE DYNAJET IC7140 SYSTEM	22
Select Gain Preset.....	23
Calibrating the System.....	24
Highest Pressure/Smallest Droplet Size	24
Lower Pressure/Larger Droplet Size	24
CHAPTER 4 - HOME SCREEN	25
Home Screen Options.....	25
Accessing the Home Screen	26
Quick Overview Box	26
Rate Controller Communications	26
Rate Controller Communications	26
Errors.....	27
Disengage Mode.....	27

CHAPTER 5 - SETUP	28
Accessing the Main Setup Screen	28
Accessing the Nozzle Favourites Screen	28
MAIN SETTINGS MENU	29
Main Setup Overview Options	29
Machine Setup	30
Gain Preset Setup	31
User Interface	33
OEM Settings	34
Help	35
About	35
System Overview	35
UT Data Diagnostics	36
Gyroscope Diagnostics	36
NOZZLE FAVOURITES	37
System Overview Options	37
Nozzle Presets	38
Current Nozzle Selection	38
CHAPTER 6 - OPERATION	39
Operation Screen Options	39
Accessing the Operation Screen	40
Droplet Size Chart	40
OPERATION MODES	40
Manual Mode	40
Droplet Mode	41
Adjustable Droplet Mode	41
BOOM APPLICATION ACTIVITY	42
CONTROL ERRORS & ALERTS	43
Pop-up Alert Screens	43
NON-TOUCHSCREEN UT OPTIONS	43
TURN COMPENSATION	44
Good Practices Guide	44
CHAPTER 7 - SYSTEM OVERVIEW	46
Accessing the System Overview Screen	47
DRIVER/SOLENOID INFORMATION	47
SYSTEM ERRORS	48
Pop-up Alert Screens	48
System Overview Screen	49
Home Screen Visibility	49
APPENDIX A – DYNAJET APPLICATION CHARTS	50
DYNAJET IC7140 NOZZLE SELECTION	50
Nozzle/Tip Selection Chart Explanation	51
Nozzle/Tip Size Selection Example	51
Nozzle/Tip Series Selection Example	51
Speed Range Available for Various Application Rates	52
APPENDIX B – TROUBLESHOOTING GUIDE	56
UNAVAILABLE MODES	56
Operation Mode	56
Disengage Mode	56
Turn Compensation	56
Turn Compensation On/Off Unavailable	56
Turn Compensation Visual Unavailable	57
Turn Compensation Unavailable	57

ALERT OVERVIEW	57
INITIALISATION BOOM SETUP ERROR WITH 8-OUTPUT DRIVERS	60
APPENDIX C – E-ChemSaver Maintenance Instructions	61
APPENDIX D – User Settings Log	69

Copyrights

© 2020 TeeJet Technologies. All rights reserved. No part of this document or the computer programmes described in it may be reproduced, copied, photocopied, translated, or reduced in any form or by any means, electronic or machine readable, recording or otherwise, without prior written consent from TeeJet Technologies.

Trademarks

Unless otherwise noted, all other brand or product names are trademarks or registered trademarks of their respective companies or organisations.

Limitation of Liability

TEEJET TECHNOLOGIES PROVIDES THIS MATERIAL “AS IS” WITHOUT WARRANTY OF ANY KIND, EITHER EXPRESSED OR IMPLIED. NO COPYRIGHT LIABILITY OR PATENT IS ASSUMED. IN NO EVENT SHALL TEEJET TECHNOLOGIES BE LIABLE FOR ANY LOSS OF BUSINESS, LOSS OF PROFIT, LOSS OF USE OR DATA, INTERRUPTION OF BUSINESS, OR FOR INDIRECT, SPECIAL, INCIDENTAL, OR CONSEQUENTIAL DAMAGES OF ANY KIND, EVEN IF TEEJET TECHNOLOGIES HAS BEEN ADVISED OF SUCH DAMAGES ARISING FROM TEEJET TECHNOLOGIES SOFTWARE.

1

2

3

4

5

6

7

8

9

A

IMPORTANT SAFETY INFORMATION

All safety related and operating instructions should be read before the system is operated. Safe operation of machinery is the operator's responsibility. Safety procedures must be posted close to the equipment and clearly visible to and legible by the operator. Safety procedures should meet all company and local regulations, as well as MSDS-requirements. For assistance, contact a local dealer.

Safety Alert Symbol Definitions:



DANGER! This symbol is reserved for the most extreme situations where serious personal injury or death is imminent.



CAUTION! This symbol indicates a hazardous situation that could result in minor or moderate personal injury.



WARNING! This symbol indicates a hazardous situation that could result in serious personal injury or death.



NOTE: This symbol addresses practices in which the operator should be aware.

GENERAL WARNINGS AND PRECAUTIONS



DANGER!

- Read and follow instructions. If instructions are unclear after reading the manual, please contact a local dealer.
- Keep children away from equipment.
- Do not operate machinery under the influence of alcohol or any illegal substance.
- Some systems include a fan heater. Never cover the heater otherwise there will be a serious danger of fire!



WARNING! ELECTRICAL / SHOCK HAZARDS

- Before working on any particular component, make sure that all power supplies have been switched off and cannot be accidentally switched on.
- Disconnect power leads before using an arc welder on equipment or anything connected to the equipment.
- Systems including frequency drives have a risk of electric shock due to residual voltage. It is not permissible to open the equipment neither to disconnect the system or any quick connection until 5 minutes after the power has been removed.
- Only operate the system from the power source indicated in the manual. If you are not sure of the power source, consult qualified service personnel.
- Do not use a high pressure cleaner to clean electrical components. This could damage electrical components and subject the operator to risk of electrical shock.
- The electrical supply to the equipment must be properly routed and connected to the equipment. All connections must meet the specified requirements.



WARNING! PRESSURISED HYDRAULIC SYSTEMS

- Always wear personal protective equipment (PPE) when performing work on hydraulic systems.
- Adhere to the machine manufacturer's approved maintenance instructions when working on the hydraulic system.
- Always turn equipment off when working on the hydraulic system. Take appropriate precautions when opening systems that have been previously pressurised.
- Be aware that hydraulic oil may be extremely hot and under high pressure.



WARNING! CHEMICAL HANDLING

- Always wear PPE when handling any chemical substance.
- Always follow safety labels and instructions provided by the chemical manufacturer or supplier.
- The operator should have full information on the nature and the quantity of the material to be distributed.
- Adhere to **FEDERAL, STATE AND LOCAL REGULATIONS REGARDING THE HANDLING, USE OR DISPOSAL OF AGRICULTURAL CHEMICALS.**



WARNING! PRESSURISED SPRAY SYSTEM

- It is important to recognise proper safety precautions when using a pressurised spray system. Fluids under pressure can penetrate skin and cause serious personal injury.
- The system pressure should never exceed the lowest rated component. Always know your system and all component capabilities, maximum pressures and flow rates.

- Filters can only be opened when the manual valves in front of and behind the filter are in closed position. If any appliance has to be taken out of the piping, manual valves in front of and behind this appliance have to be in closed position. If they are reinstalled, make sure that this happens correctly, that this apparatus is well aligned, and that all connections are tight.
- The plumbing supply to the equipment should meet all company and local regulations and must be properly routed and connected to the equipment. All connections must meet the specified requirements.
- It is advised to drain and purge the liquid train when the equipment shall not be used for a longer period of time.



WARNING! AUTO STEERING SAFETY

- To prevent serious personal injury or death from being run over by the vehicle or automated motion of the steering system, never leave the vehicles operator seat with the system engaged.
- To prevent serious personal injury or death from being run over by the vehicle or automated motion of the steering system, verify the area around the vehicle is clear of people or obstacles before startup, calibration, tuning or engaging the system.
- Make sure equipment is tightly secured to the proper components.
- Never drive on public roads with system engaged.



CAUTION! EQUIPMENT SAFETY, MAINTENANCE, AND SERVICE

- The equipment should be operated only by properly trained, qualified personnel. They must have proven their skills in the operation of the equipment.
- Before using the equipment, the operator has to check if the equipment is in good condition and can be used safely. If not, the equipment cannot be used.
- All necessary PPE must be readily available to the operator at all times.
- Routinely check the system and components for wear and damage. Replace or repair when necessary.
- Only qualified authorised experts are allowed to repair or maintain the installation. The maintenance and operating instructions shall be rigidly observed and followed.
- A complete manual for the equipment must be available to the operator or maintenance technician at all times.



CAUTION! HARNESS CABLE AND HOSE SAFETY

- Routinely check all harness cables and hoses for damage or wear. Replace or repair when necessary.
- Do not route harness cables and hoses with sharp bends.
- Do not strap harness cables and hoses to lines with high vibration or spikes in pressure.
- Do not strap harness cables and hoses to lines transporting hot fluids.
- Protect harness cables and hoses from sharp objects, equipment debris, and material buildup.
- Allow sufficient length for harness cables and hoses to have free movement on sections that move during operation, and be sure that harness cables or hoses do not hang below the equipment.
- Allow sufficient clearance for harness cables and hoses from implement and machine operational zones.
- When cleaning equipment, protect harness cables from high pressure wash.



NOTE: TOUCH SCREEN CARE

- Keep sharp objects away from the touch screen device. Touching the screen with a sharp object could result in damage to the display.
- Do not use harsh chemicals to clean the console/display. The correct way to clean a console/display is to use a soft damp cloth or anti-static wipe, similar to cleaning a monitor on a computer.



NOTE: RECOMMENDED REPLACEMENT PARTS

- The system has been designed with components that work together to provide the best system performance. When the system requires replacement parts, only TeeJet recommended components should be used to maintain proper system operation and safety.



CHAPTER 1 - INSTALLATION & UPDATING

DynaJet IC7140 installation includes eight (8) output driver options where each driver consists of eight (8) nozzle harnesses and is tailored to the customer's specific equipment.

DYNAJET IC7140 ECU

The DynaJet IC7140 controller works in conjunction with an existing rate controller to achieve a target application rate while maintaining target droplet size(s) when a speed change occurs.

The DynaJet IC7140 controller changes flow output to each individual nozzle based upon input provided from the operator about the optimum droplet size (target pressure) for the application.

Figure 1-1: DynaJet IC7140 Controller



Item	Description
1	Pressure Interface Harness connector <i>NOTE: A pressure interface harness may not be included in all configurations. When not in use, use the provided cap to enclose this connector port.</i>
2	DynaJet IC7140 ECU Main Harness connector
3	Product and serial number label
4	Mounting tabs
5	Programming Port

NOTE: Verify the unit is secured with the four mounting screws before using the DynaJet IC7140. Keep magnetic and electromagnetic devices away from the DynaJet IC7140 system. Mounting the DynaJet IC7140 system in areas of high vibration can adversely affect the system operation. It is highly recommended to mount directly to the vehicle's main frame or to something directly connected to the main frame.

Figure 1-2: DynaJet IC7140 ECU Top and Bottom Views

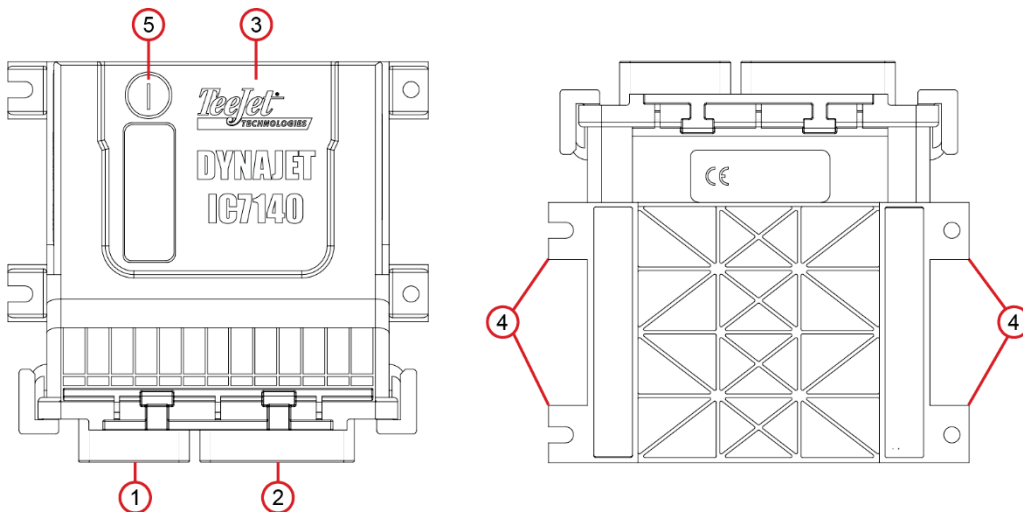

Software Updates

As TeeJet Technologies continues to enhance its software, updates for the console will be made available at www.teejet.com. See DynaJet Software Update Instructions bulletin 98-01571 at the end of this chapter for details and instructions.

ECU Orientation

The DynaJet IC7140 ECU needs to know which orientation it is mounted, or the system will not work properly. Note the direction of the ECU label, connections, and left/right edges in relation to the forward facing direction of the vehicle. The view will always be as if the operator is looking down from the top of the cab.

- The DynaJet IC7140 ECU must be mounted securely to a surface that is firmly mounted to the vehicle and moves in unison with the GNSS antenna.
- During DynaJet IC7140 console setup in Main-> OEM Settings the orientation of the DynaJet IC7140 ECU must be accurately specified in "ECU Orientation".

Orthogonal Orientations

The DynaJet IC7140 ECU is to be mounted orthogonally on the vehicle. This means that the DynaJet IC7140 ECU is at a 90° angle or some multiple of 90 (0, 90, 180, 270) degrees at all three axes (vertically, horizontally, and perpendicular to the other two) when compared to the direction of travel of the vehicle.

Select one of the six (6) possible orthogonal orientations at which the DynaJet IC7140 ECU is installed.

- ◀ Horizontal, Label Up (default installation position)
- ◀ Horizontal, Label Down
- ◀ Vertical, Connectors Up
- ◀ Vertical, Connectors Down
- ◀ Vertical, Left Edge Up
- ◀ Vertical, Right Edge Up

Figure 1-3: Orthogonal Orientations as Compared to Vehicle Orientation

Orthogonal orientation is as if looking down at the ECU from above.

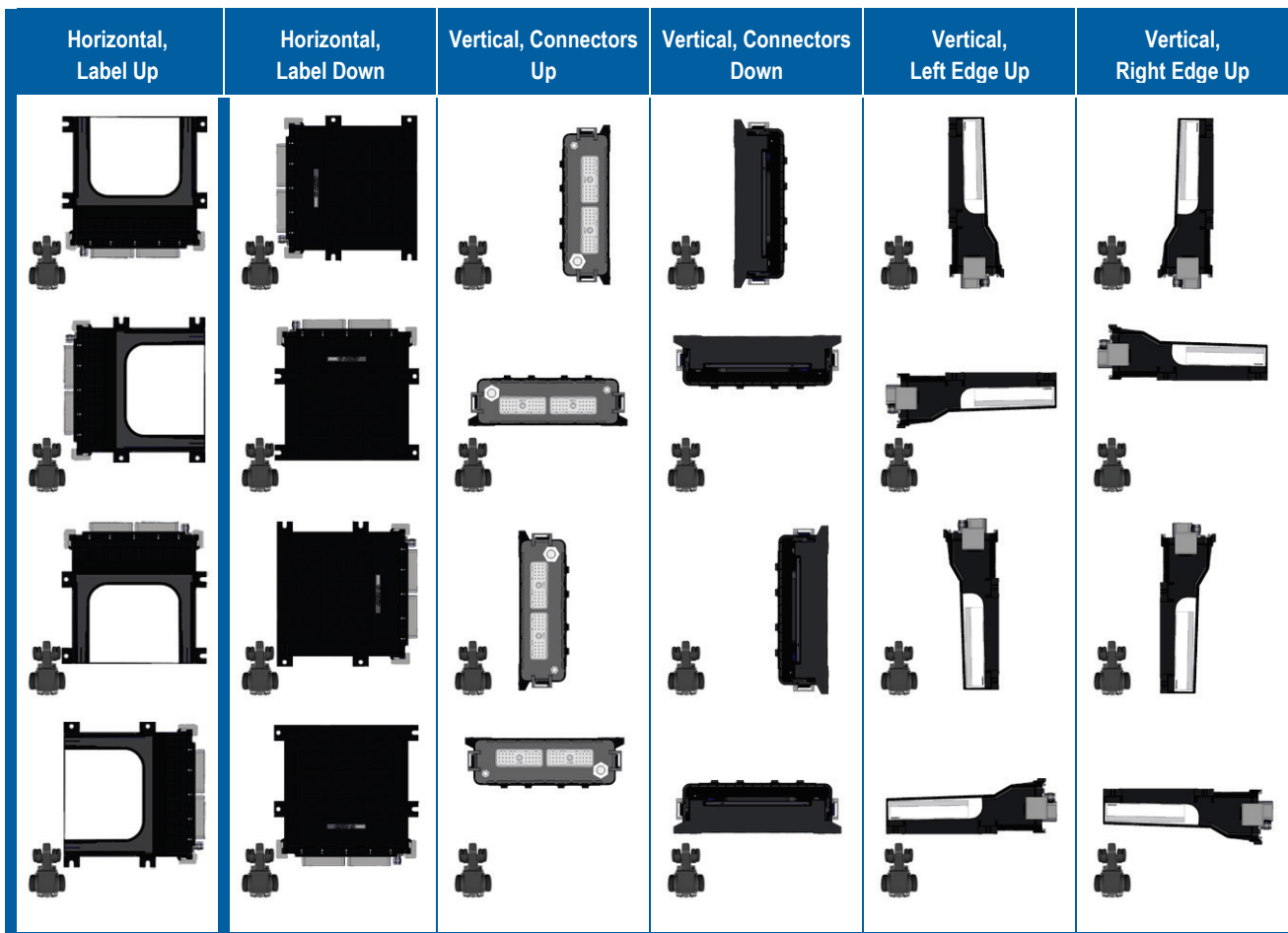

Default Installation Position

Caution – "Vertical, Connection Up" should only be used when no other orientations are available.

COMPONENT INSTALLATION

DynaJet IC7140 installation includes eight (8) output driver options where each driver consists of eight (8) nozzle harnesses and is tailored to the customer's specific equipment. The following is general installation information. Specific instructions will be based on selected components and will be tailored to the machine.

Installation System Components

Item	Part Number	Description
1	DM-01	DynaJet IC7140 ECU Module
2-1	Number dependent on components	DynaJet ECU Harness
2-2	50-05222	18 Position Cinch Dust Cap
3	16-05015	Pressure Sensor
4	45-05887: 3' / 1 m 45-05886: 25' / 7.5 m	Pressure Sensor Cable <i>(only required with 45-10207 DynaJet Hybrid ECU Harness)</i>
5	78-05137	Pressure Interface <i>(only required with 45-10207 DynaJet Hybrid ECU Harness)</i>
6	45-10195	Boom Interface Module (BIM) Hybrid Harness
7	45-04006-03: 3' / 1 m 45-04006-07: 7' / 2 m 45-04006-13: 13' / 4 m 45-04006-20: 20' / 6 m	CAN Extension Cable
8	45-04006-END	CAN Terminator-END
9	45-04006-START	CAN Terminator-START
10	78-05091, up to 15 sections (1-15) 78-05128, up to 30 sections (16-30)	Boom Interface Module (BIM)
11	45-05998-xx	Power Adapter
12	78-05124	DynaJet HF Driver
13	45-04005-xx-xx	Nozzle Harness
14	45-05971	Power Extension Driver
15	45-05997-15	Driver Power "Y" Cable
16	78-05121-xx	Power Distribution Module (PDM)
17	45-05942-xx	Power Cable, 6 gauge
18	45-05943	Battery Cable, 60 amp Fused
19	45-04001-xx	Nozzle Extension

Figure 1-4: DynaJet IC7140 Hybrid System Diagram

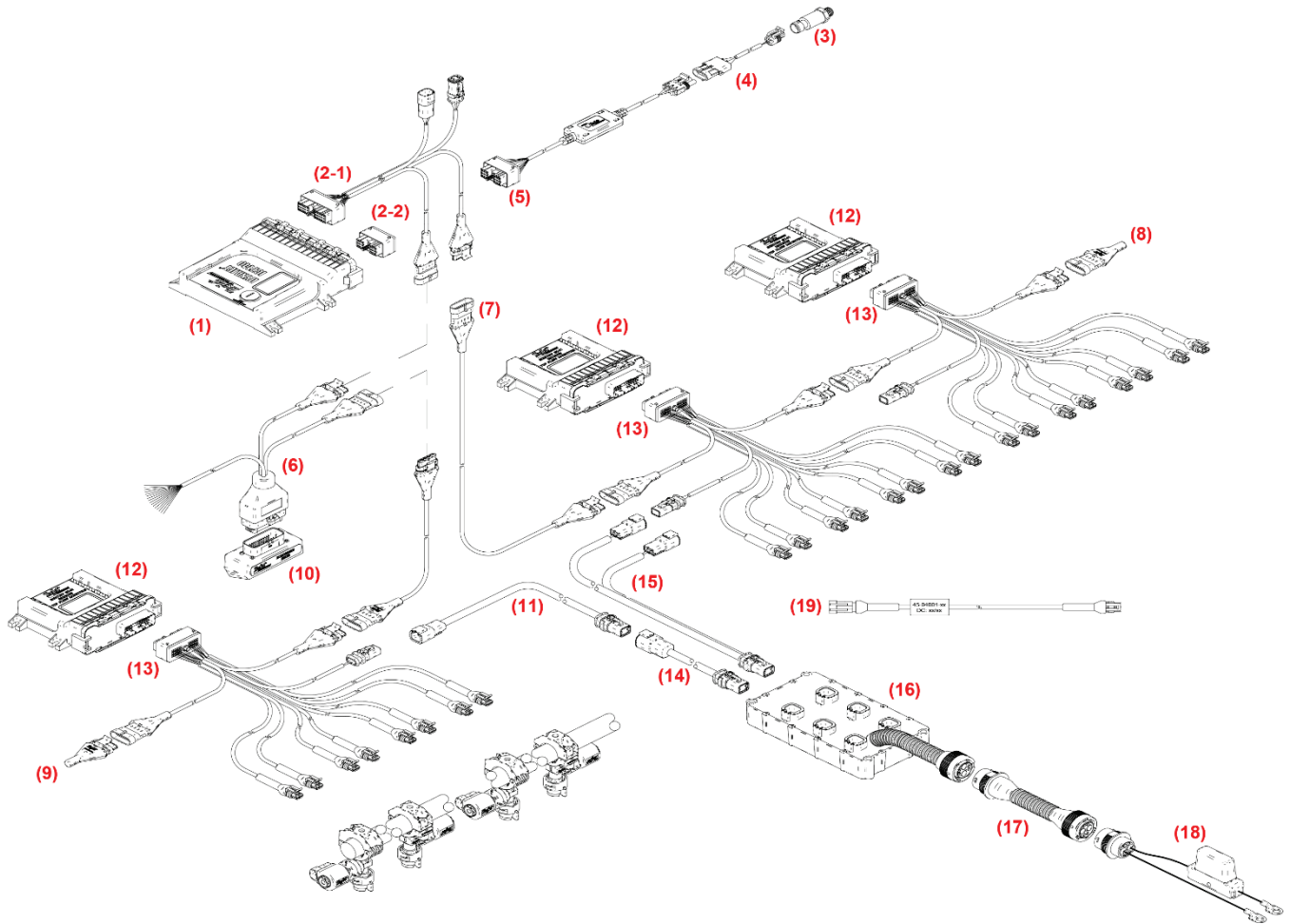

Component Installation Instructions

Power Source

Power must be sourced from the battery using a (18) 60 amp fused battery cable [45-05943] which connects to a (17) 6 gauge power cable [45-05942-xx] to connect to the (16) Power Distribution Module [78-05121-xx].

Power must be routed from the (16) Power Distribution Module [78-05121-xx] to each (13) Nozzle harness [45-04005-xx-xx] (which connects to each (12) DynaJet IC7140 driver [78-05124]) using a (14) Power Extension Driver cable [45-05971-xx], (15) Driver Power "Y" cable [45-05997-xx] and/or (11) Power Adapter cable [45-05998-xx].

Drivers Modules and Terminators

There will be one (12) DynaJet IC7140 Driver [78-05124] per eight (8) nozzles.

- Mount each DynaJet IC7140 driver centered within the eight (8) nozzles it controls.

The (9) Start Terminator 45-04006-START must be connected to the DynaJet IC7140 driver 78-05124 for section 1.

The (8) End Terminator 45-04006-END must be connected to the Driver module 78-05124 for the last section.

Nozzle Harnesses

When installing (13) Nozzle Harnesses [45-04005-xx-xx] always start with section 1 and continue to the last section, working left to right (while facing in the machine's forward direction)

Nozzle harnesses are designed for your specific nozzle spacing.

CAN Cables

(7) CAN cables [45-04006-xx] must be connected in series between each (13) Nozzle harness [45-04005-xx-xx] through the (2-1) DynaJet ECU Harness.

Pressure Sensor

Without a Pressure Interface

(4) Pressure Sensor Cable [45-05887 or 45-05886] connects the (2) DynaJet ECU Harness to the (3) Pressure Sensor [16-05015]. Extension cables 404-0045 or 404-0039 are also available to connect the pressure sensor to the DynaJet Hybrid ECU Harness.

Use (2-2) 18 Position Cinch Dust Cap to cover the open port on the (1) DynaJet IC7140 ECU Module

With a Pressure Interface

(5) Pressure Interface [78-05137] connects to the (1) DynaJet IC7140 ECU Module. (4) Pressure Sensor Cable [45-05887 or 45-05886] connects the (5) Pressure Interface [78-05137] to the (3) Pressure Sensor [16-05015]. Extension cables [404-0045 or 404-0039] are also available to connect the pressure sensor to the Pressure Interface.

Boom Interface Module (BIM)

(6) Boom Interface Module (BIM) Hybrid harness [45-10195] connects between the (2) DynaJet ECU Harness and a (7) CAN cable [45-04006-xx].

The (10) Boom Interface Module (BIM) [78-05091 or 78-05128] connects to the (6) Boom Interface Module (BIM) Hybrid harness [45-10195].

Figure 1-5: Installation

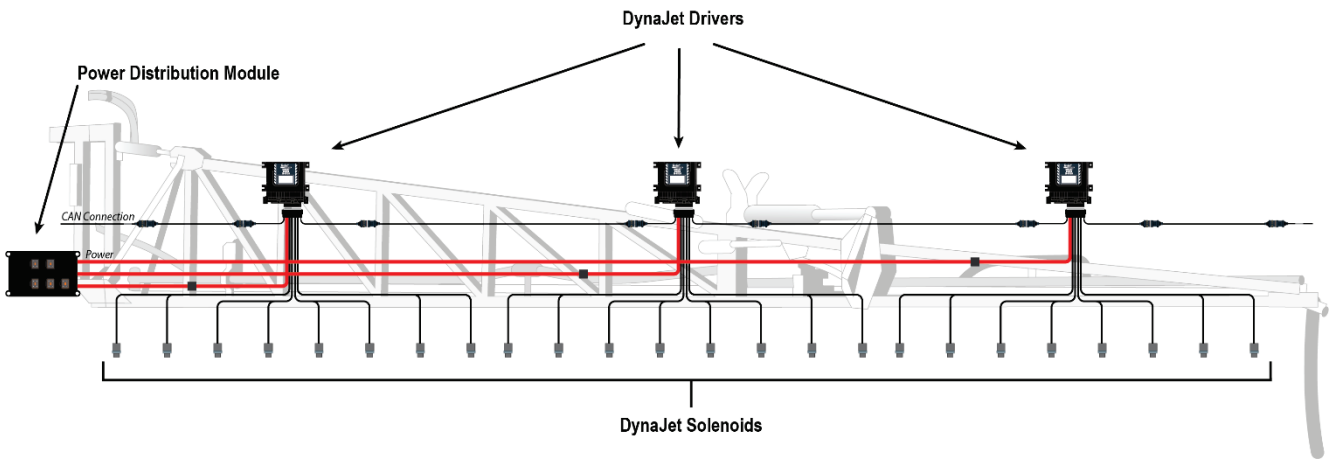

DynaJet® IC7140

As TeeJet Technologies continues to enhance its software, updates for the console will be made available at www.teejet.com. You must have the software update folder stored on a USB storage device prior to beginning the update.

RECOMMENDATION: Be parked while the update is in progress. This will help ensure that the update process is not interrupted by the USB drive bouncing around while the vehicle is in motion.

NOTES:

- ▶ The file is in a compressed zip format and needs to be unzipped/ uncompressed before loading onto the USB drive.
- ▶ The software update file can be used on multiple consoles.

WARNING! Do not use a USB storage device with U3 technology (also known as "U3 smart drives") as U3 technology could cause downloading issues.

Settings May Not Be Retained

Updating from early releases (before sv1.11) of the DynaJet IC7140 may not retain all programmed settings or configurations. It is always recommended to notate the current configurations using the 98-01557 User Settings Log available at www.teejet.com.

Check the USB Drive

The programming port on the module has limited access space. This can lead to some USB drives to not fit into the USB port.

1. While the DynaJet IC7140 is off, unscrew the Programming Port cover (A) using a large flat head screwdriver.

CAUTION: Removal of the Programming Port cover exposes internal parts of the ECU. The cover should be off only when using the USB port. Be cautious to keep the port clean and dry.

2. Insert the intended USB drive into the DynaJet IC7140 ECU USB port (B), verifying that it fully seats within the port.

WARNING: Do not start the system while USB is inserted.

3. Remove USB drive.
4. Replace the Programming Port cover when finished. Tighten securely to avoid water leaks.

If the USB drive fits, proceed to the Software Installation.

If the USB drive does not fit, try a different USB drive, or use a USB extension cable.

Figure 1: Programming Port Location

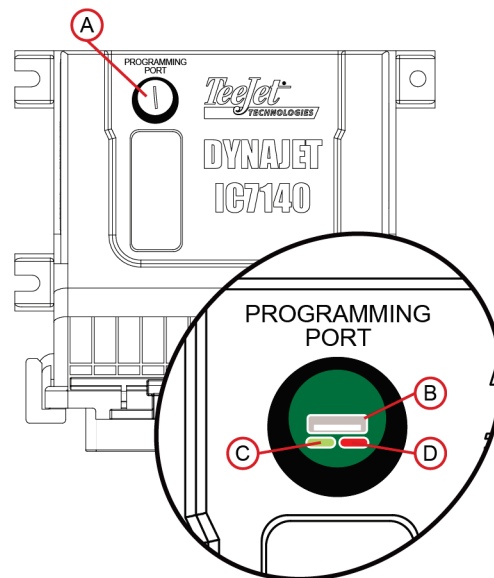

Software Installation

Prepare Files

1. Download the software zip file directly to your computer's Desktop or Downloads folder (see "How to download ZIP files.pdf" for details).
2. Double click the zip file then select either A or B:
 - a. Copy and paste the "tjrun" folder to the root directory of an empty USB drive.
 - b. Using the "Extract all files" function, unzip/decompress the downloaded files to the root directory of an empty USB drive (see "How to download ZIP files.pdf" for details).

Once downloaded and unzipped, you will see the "tjrun" folder on your USB drive.

RECOMMENDATION: Use an empty USB drive. Be sure there are no other automatically executable files on the drive.

3. Properly eject the USB drive from your computer using the "Safely Remove Hardware" icon from the Task Bar or the "Eject this disk" function from the My Computer window or the "Eject Disk" option (on a MAC).

Program the Module

4. With the system ON and the DynaJet IC7140 fully loaded, unscrew the Programming Port cover (A) using a large flat head screwdriver.

CAUTION: Removal of the Programming Port cover exposes internal parts of the ECU. The cover should be off only when using the USB port. Be cautious to keep the port clean and dry.

5. Insert the USB drive into the DynaJet IC7140 ECU USB port (B).

WARNING! Do not remove the USB drive or disconnect power from the console at any time during the update process. The update will start automatically.

6. Wait for the programming to complete.
 - a. Shortly after the USB drive is inserted, a Lost Communication Alert will be shown. Do not be alarmed by this. It is expected behaviour.
 - b. The Programming Port LED (D) will turn RED while the module is programming. Programming can take a few minutes.
 - c. When the module has completed programming, the Programming Port LED (C) will turn GREEN.
7. Once the Programming Port LED (C) turns GREEN, remove the USB drive.
8. Replace the Programming Port cover (A). Tighten securely to avoid water leaks.
9. Restart the system.

To verify your update has installed, check the software version number on the **Main-> Help-> About** screen.

Driver Updates

If the software update included updates to the drivers, the driver update will be run after restart.

10. A Driver Update Progress screen will be shown. Each driver may take up to 18 seconds to update.
11. Once complete, restart the system again.

To verify your update has installed, check the driver software version number on the **System Overview** screen.

Adding Languages

When updating early releases (before sv1.11) using a USB drive, the inclusion of non-English languages needs to be run as a separate update.

1. Follow same procedure as general software installation using the language installation zip file.

To verify non-English languages have installed, change the console language.

Please contact TeeJet Technologies with any questions or for assistance.

TEEJET TECHNOLOGIES IS NOT RESPONSIBLE FOR DAMAGE DUE TO IMPROPER DOWNLOAD AND INSTALLATION OF AN UPDATE



CHAPTER 2 - SCREEN INTRODUCTION

Congratulations on the purchase of your new DynaJet IC7140 ECU built on the ISOBUS architecture. When used within the guidelines of this manual, the DynaJet IC7140 will be a reliable droplet size control system.

BASIC SCREEN USE

The DynaJet IC7140 display comprises Available ECU buttons, an interactive information display and softkeys.

- A firm touch is required when selecting a screen icon.
- Setup options are NOT automatically saved when selected.
 - ✔ The ACCEPT KEY must be selected to save the setting.
 - ✘ Select the ESCAPE KEY to escape without saving settings and return to the previous menu.

NOTE: The softkey menus and touch screen structure on your display might vary from the one displayed in this user manual depending on the universal terminal being used.

Figure 2-1: Screen Overview

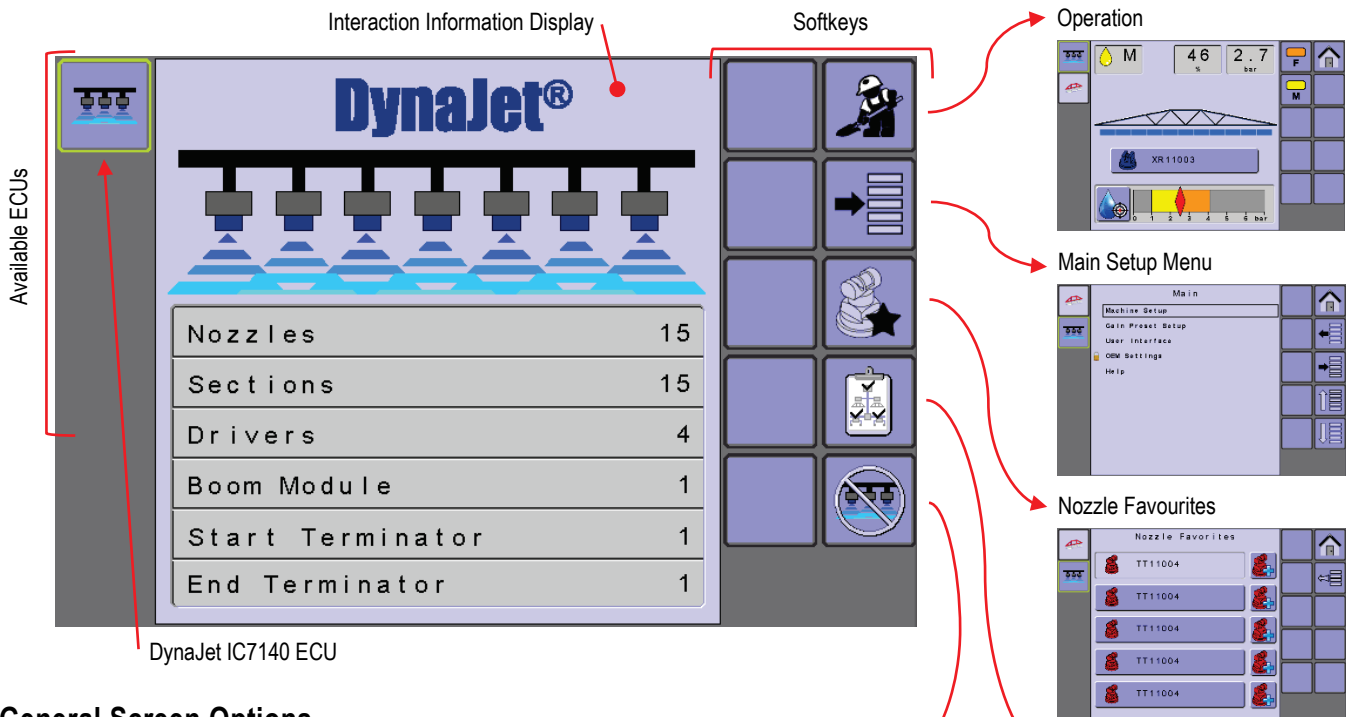

General Screen Options

- ▶ Available ECUs – Systems currently available on your UT are displayed in the left hand column of every screen. The highlighted ECU icon indicates the ISOBUS system component that is in focus. To navigate between systems, press the desired system’s icon.
- NOTE: Icons vary depending on systems available components.*



DynaJet IC7140 ECU – Press to access the DynaJet IC7140 system.

A progress bar may be shown on the icon during start up while the system loads and communicates with all components.

Disengage Mode

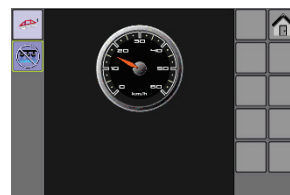

System Overview

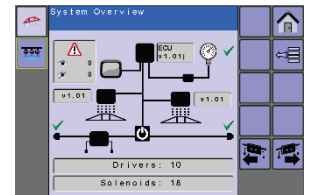



While DynaJet is in Disengage Mode, press to go to DynaJet IC7140 ECU.

- ▶ Interactive Information Display – Displays all system information, menus and operation interactions as well as may contain buttons for additional screen options or settings.
- ▶ Softkeys – Displays buttons [with or without icons] to access additional menus or screens, to change settings on the current screen and/or to enhance settings or operation functions. Softkeys without an icon do not have associated functions.

How to Navigate Settings Options

Settings are selected from either a list of options or by entering a numeric value.

Selecting from a List

Highlight the option using the Up/Down Selection Arrows then use the Accept button to save the selection.

Figure 2-2: Setting from a List Example

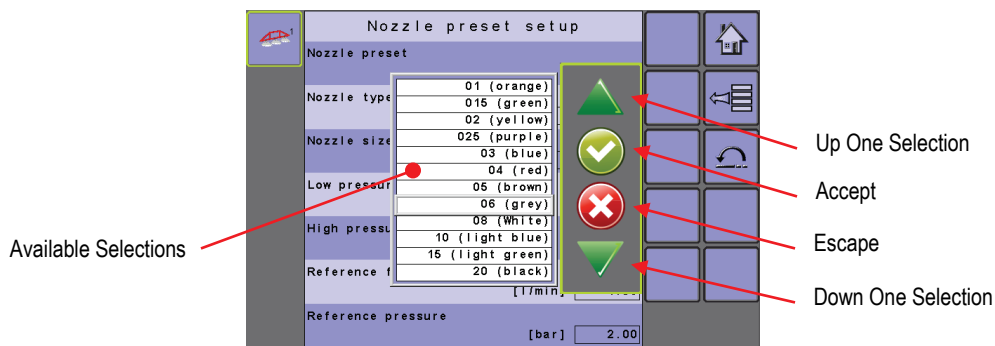

Figure 2-3: Settings Options with List

Section or icon	Description
Available Selections	A list of available options for the selected setting.
Up One Selection Arrow	Moves selection box up
Down One Selection Arrow	Moves selection box down
Accept	Accepts and saves settings
Escape	Escapes without saving changes

Selecting a Numeric Value

Enter the numeric value using the slide bar or number pad then use the Accept button to save the value.

Figure 2-4: Setting a Numeric Value Example

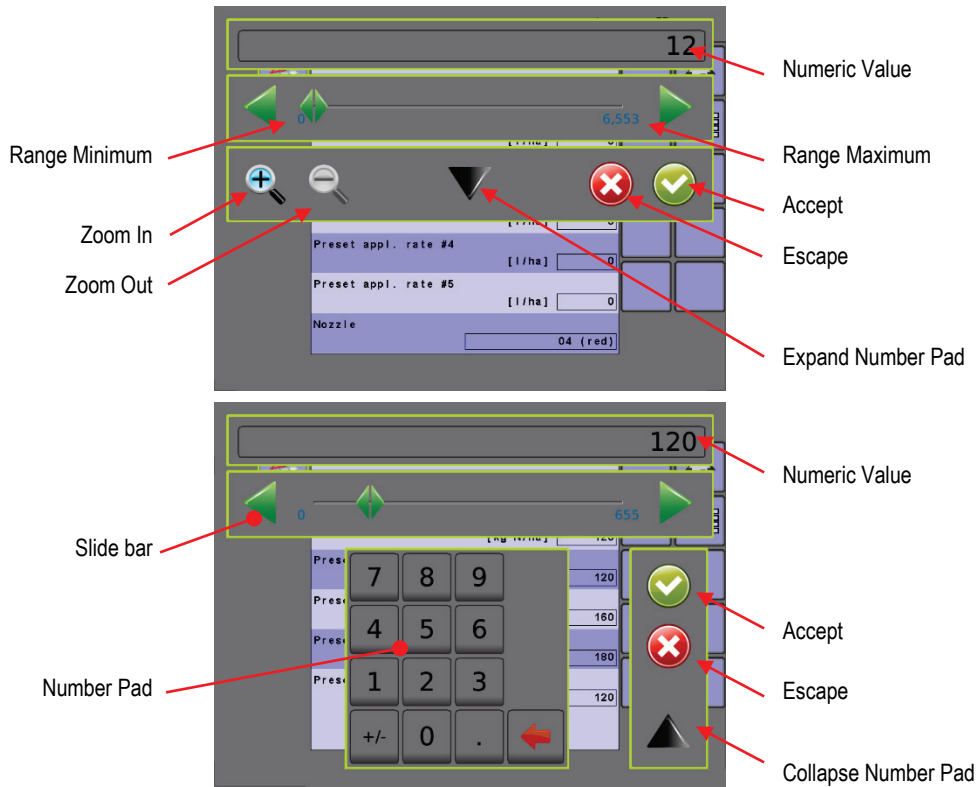











Figure 2-5: Settings Options with Number Pad

Section or icon	Description
Numeric Value	Displays the current numeric value
Slide Bar	Selects the value by pressing and releasing on the slide bar or pressing and dragging the slider to a designated value. The range for a specific setting is displayed on the slide bar.
 Slider	Slide to the left to decrease or right to increase the numeric value
 Increase Arrow	Increases the numeric value
 Decrease Arrow	Decreases the numeric value
Number Pad	Use to set the numeric value
 Collapse Number Pad	Hides the number pad
 Accept	Accepts and saves settings
 Escape	Escapes without saving changes
 Expand Number Pad	Reveals the number pad
 Zoom In	Narrows slide bar range. Grey = maximum zoom level.
 Zoom Out	Expands slide bar range. Grey = minimum zoom level.

CHAPTER 3 - INITIAL START-UP & CALIBRATIONS

The following is the steps required for first-time setup of the DynaJet IC7140 system. When these settings and calibrations are completed, operation should be possible.

WARNING! With each nozzle change or when nozzles are replaced, a system calibration (steps NO. 5 CALIBRATE THE RATE CONTROLLER REGULATION and NO. 6 CALIBRATE THE DYNAJET IC7140 SYSTEM) must be completed before attempted operation. These configurations may affect Gain settings. Failure to properly configure and calibrate the system will result in sub-standard performance. Once complete, operation may proceed.

NOTE: Information on the ECU will vary depending on the parameters set by the user and the OEM.

NO. 1 POWER UP AND INITIALISATION

Power is continuously supplied to the controller. The universal terminal (UT) will give access to the controller options and operation.

- The console needs to be cycled off and back on when changing or attaching other or additional electronic components to the system.

Upon startup, the system will cycle the following screens.

- ▶ Initialisation screen – During power-up, the Initialisation screen is displayed for five (5) seconds, or until all drivers are scanned.
- ▶ End User Licence Agreement – appears after the Initialisation screen and will not allow Home Screen access until it has been acknowledged by pressing the Accept button.
- ▶ Home screen – Once initialisation is complete and the End User Licence Agreement is acknowledged, the Home screen will appear. Multiple values are displayed on the Home screen offering a quick overview of the state of the system components. When a rate controller is on the system and communicating, displaying section and boom module interface information is not required nor displayed.

WARNING! Do not move the machine until the Home screen has been reached.

Figure 3-1: Power Up and Initialisation Sequence

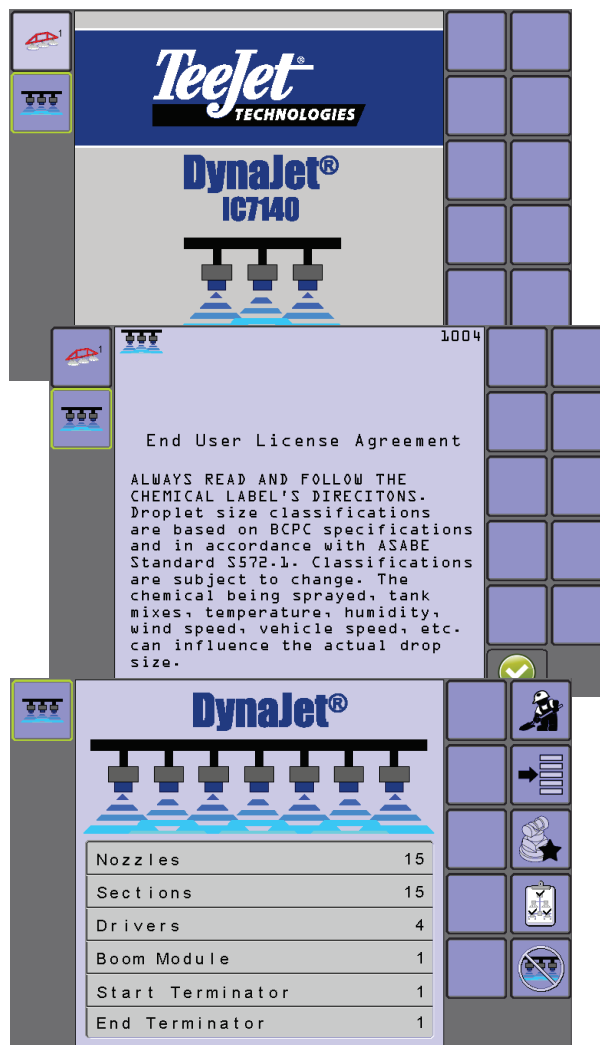

NO. 2 ESTABLISH SELECT SETTINGS

Enter Unlock Codes

Unlock codes are found in the Main Menu screen under the User Interface options. When initially setting up the system, some features may need to be unlocked before they will be available. All unlock codes require the console to be restarted.

Contact an authorized TeeJet Technologies local dealer for unlock code availability.

1. From the Home screen, press the MAIN SETUP KEY.
2. Select **User Interface**.
3. Select and enter unlock codes as available:
4. As instructed on the Unlock Code Instruction Bulletin, restart the console.

Figure 3-2: Machine Setup

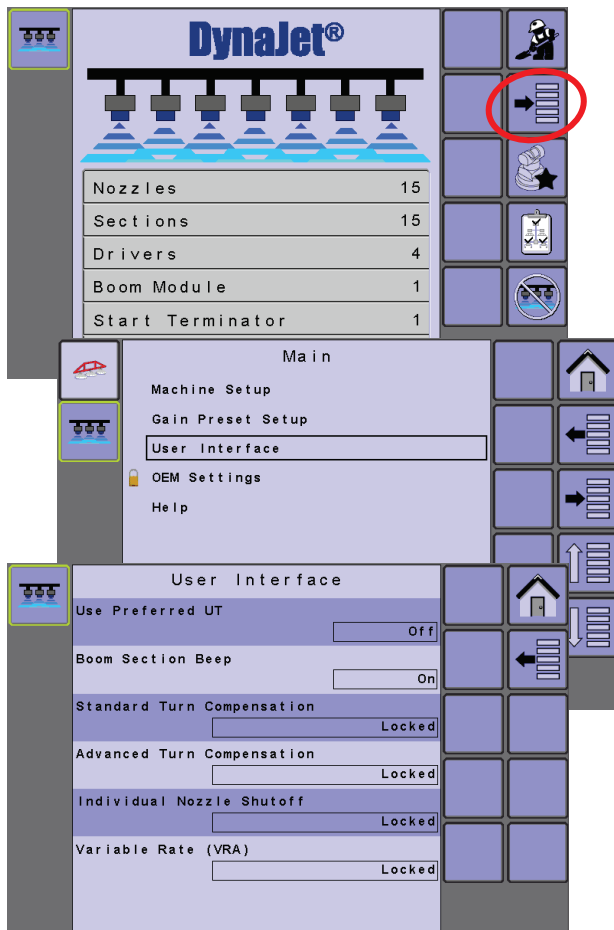

Machine Setup

With Rate Controller Communications

Machine Setup is found in the Main Menu screen. When initially setting up the system, setting parameters for Pressure Sensor Max is strongly suggested. Other machine settings and user parameters can be adjusted as needed after calibrating the system.

NOTE: Gain settings will be calibrated in following sections.

1. From the Home screen, press the MAIN SETUP KEY.
2. Select **Machine Setup**.
3. Establish:
 - ▶ Pressure Sensor Max – Enter the maximum pressure value as indicated on the pressure sensor label.

Figure 3-3: Machine Setup with Rate Controller Communications

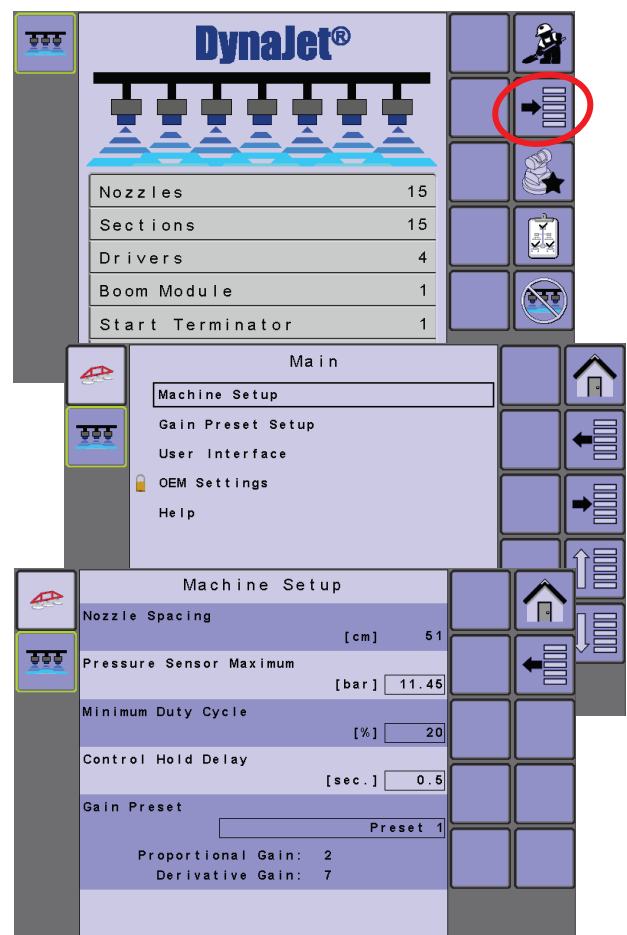

No Rate Controller Communications

Machine Setup is found in the Main Menu screen. When initially setting up the system, setting parameters for Number of Sections, Nozzles per Section, and Pressure Sensor Max is strongly suggested. Other machine settings and user parameters can be adjusted as needed after calibrating the system.

NOTE: Gain settings will be calibrated in following sections.

1. From the Home screen, press the MAIN SETUP KEY.
2. Select **Machine Setup**.
3. Establish:
 - ▶ Number of Sections – Set the number of boom sections.
 - ▶ Nozzles per Section – Press the ARROW BUTTON to go to the Nozzles per Section Screen. Enter a value for each section.
 - ▶ Pressure Sensor Max – Enter the maximum pressure value as indicated on the pressure sensor label.

Figure 3-4: Machine Setup

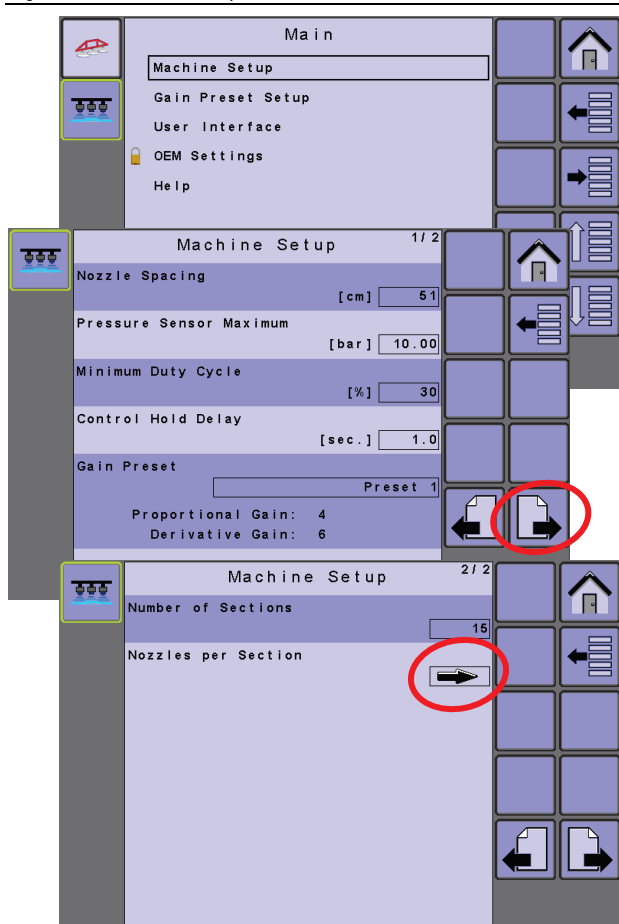

Setup and Select Nozzle

Preset nozzle favourites allows saving of up to five (5) nozzles for quick recall. Use this to quickly access the most frequently used spray nozzles including these being used for initial startup calibrating.

When communicating with a rate controller, be sure that both the rate controller and the DynaJet are set to the same nozzle.

Establish Nozzle Favourite(s)

1. From the Home screen, press NOZZLE FAVOURITES KEY.
2. Select ADD NOZZLE BUTTON. Nozzle selection will be established in the associated favourites location.
3. On the Nozzle Selection screen,
 - ◀ Select a nozzle series.
 - ◀ Select the nozzle capacity.
4. Press the PREVIOUS SCREEN KEY to complete the selection and return to the Nozzle Favourites screen.
5. Repeat steps 2-3 to establish additional nozzle favourites.

Select Current Nozzle

If more than one favourite is established:

1. Select the nozzle to be used during the System Functional Test.

Figure 3-5: Nozzle Selection

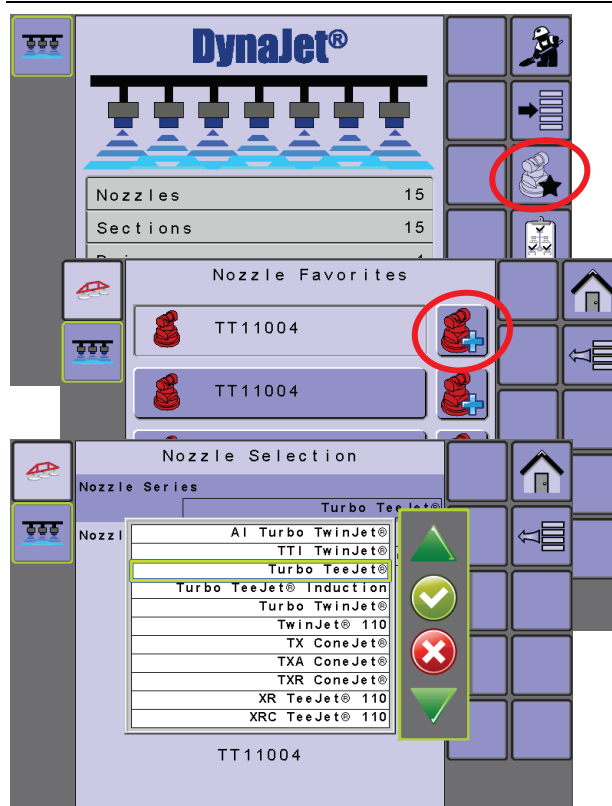

NO. 3 GET TO KNOW THE CONTROL MODES

To begin calibrating the system, an operation mode needs to be established. There are three types of Operation Modes:



Manual Mode – Select the intended nozzle and the target PWM Duty Cycle Percentage. The system will calculate and display the droplet sizes for the nozzle selected. DynaJet IC7140 will control to the target Duty Cycle Percentage.



Droplet Mode – Select the intended nozzle and the target droplet size range. The system will calculate and display the median boom pressure required to meet this droplet size range for the nozzle selected. DynaJet IC7140 will control to maintain the target droplet size range.

NOTE: Droplet Mode may not be available with all system configurations.



Adjustable Droplet Mode – Select the intended nozzle and the droplet size range with the option to adjust the target droplet size. The system will calculate and display the droplet size for the nozzle selected at the target droplet size. DynaJet IC7140 will control to maintain the target droplet size.



NOTE: Many factors including but not limited to application rate, material density, speed, nozzle model/size/spacing may limit the ability of DynaJet IC7140 to meet the control target.

See the “OPERATION” chapter for more details on each mode.

To select an operation mode:

1. From the Home screen, press the OPERATION KEY.
2. Press the CURRENT OPERATION MODE INDICATOR & MODE CHANGE BUTTON on the Nozzle Pressure Gauge. Modes will toggle from Manual Mode to Droplet Mode to Adjustable Droplet Mode.

Figure 3-6: Operation Mode from Home Screen

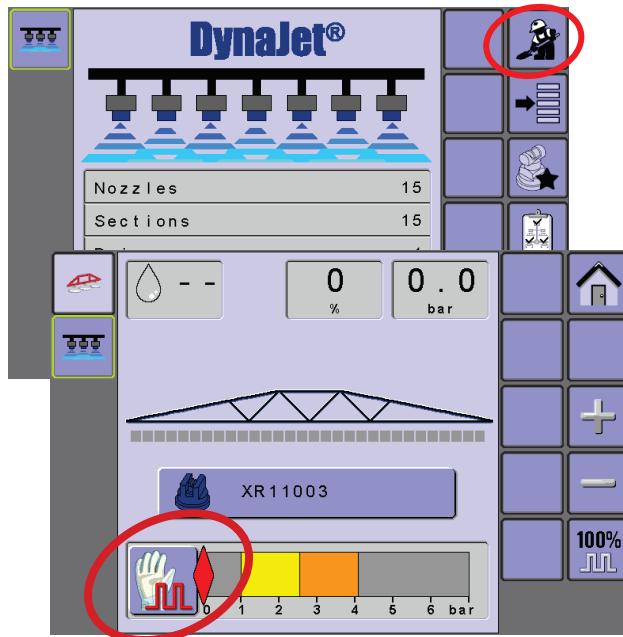

NO. 4 PREFORM SYSTEM FUNCTIONAL TEST

Prior to attempting to use the DynaJet IC7140, perform the following functional test of the system. Further details for fine-calibrating the system are in “Calibrate the DynaJet IC7140 System” section of this guide.

Ensure Current Rate Control System is Operating Normally

1. On the UT, bring DynaJet IC7140 into focus, navigate to the Operation screen
2. Set DynaJet IC7140 operating mode to Manual Mode.
3. Using the PWM INCREASE KEY, set PWM duty cycle at 100%. This will make the system operates as if DynaJet IC7140 was not present.
4. Use this configuration to verify the rate control system is operating normally.

Confirm Boom Sections are Functioning

1. Continue operating DynaJet IC7140 in Manual Mode.
2. Using the PWM DECREASE KEY, set PWM duty cycle to 50%.
3. Switch the master switch ON (on rate controller or other boom section control switches)
4. Using the switch box, turn ON each section verifying the proper section turns the associated nozzles blue on the DynaJet IC7140 operation screen.
5. Turn the master switch OFF. On the DynaJet IC7140 operation screen, verify all sections' associated nozzles are now grey.

Confirm Each of the Corresponding E-ChemSaver® Solenoids Is Pulsing

1. Verify that the pressure on the mechanical gauge is close to the digital pressure display on the DynaJet IC7140 operation screen.

NOTE: Due to mechanical losses the sensors will not be an exact match. Enter the maximum pressure value as indicated on the pressure sensor label.

NO. 5 CALIBRATE THE RATE CONTROLLER REGULATION

The following procedure will help determine the rate controller valve gain that is the most aggressive value that will work over all pressure ranges.

NOTE: DynaJet IC7140 Gain settings will be calibrated in following section.

Before you begin:

- Ensure product pump is providing flow greater than the maximum demand of the system. Consult sprayer manufacturer specifications.
- Understand that the most aggressive value will be found by increasing valve gain until system oscillates and then decreasing the setting until the system is stable at that value.

NOTE: Other rate controller specific settings may apply based on your specific rate controller system

- The rate controller must be operating in automatic mode during these tests.
- To attain the minimum and maximum operating pressures for the specific nozzle in use under each test condition, the user must be able to either: a) adjust the target application rate, or b) adjust the machine speed.
- Current Nozzle on the DynaJet must be the same as installed on the system as well as selected on the rate controller.

Flow Pulses Tests

The following tests will confirm that pulse of flow through the solenoids will not affect rate controller stability even when duty cycle is below 50%.

1. Set DynaJet IC7140 operating mode to Manual Mode.
2. Using the PWM INCREASE KEY, PWM DECREASE KEY or 100% DUTY CYCLE KEY, set PWM duty cycle as noted in each test.



PWM Increase – Press to increase the PWM Duty Cycle Percentage.



PWM Decrease – Press to decrease the PWM Duty Cycle Percentage



100% Duty Cycle – Press to jump the PWM duty cycle percentage to 100% (or the preset maximum Duty Cycle)

3. Perform tests as specified in the following sections, taking note of the pressure levels during each test.
4. Set rate controller valve gain to the highest value that will work with all three of the following tests. This will be the lowest gain value found in the 3 tests. Once established, this value should not need to be changed again.

Controller Gain Value	Minimum	Maximum
Test 1 – Duty Cycle 100%	3	5
Test 2 – Duty Cycle 50%	2	3
Test 3 – Minimum Duty Cycle	3	4

If the system does not control acceptably with this gain value at all manual duty cycle settings, then something is wrong with the system that needs to be resolved before trying to calibrate the DynaJet IC7140 System. Contact TeeJet Technologies Customer Support or an authorised TeeJet Technologies dealer if additional support is required.

Selected Nozzle Minimum and Maximum

Notate the following about the current nozzle.

1. Current nozzle: _____
2. Minimum Pressure: _____
3. Maximum Pressure: _____

Series	Pressure Range	
	psi	bar
XR TeeJet 110	15-60	1-4
XRC TeeJet 110	15-60	1-4
Turbo TeeJet	15-90	1-6.25
Turbo TeeJet Induction	15-100	1-7
TTI TwinJet	20-100	1.25-7
TwinJet 110	30-60	2-4
Turbo TwinJet	20-90	1.25-6.25
AI Turbo TwinJet	20-90	1.25-6.25
TX ConeJet	30-300	2-20
TXA ConeJet	30-300	2-20
TXR ConeJet	30-360	2-25

Test 1 – Duty Cycle 100%

1. Start by setting DynaJet IC7140 duty cycle to **100%**.

Test 1A – Minimum Operating Pressure

Determine rate controller gain value with operating pressure at MINIMUM.

2. Reduce target rate or machine speed until system reaches the minimum operating pressure.
3. Adjust the rate controller gain value until stable.

Controller gain value at minimum pressure: _____

Test 1B – Maximum Operating Pressure

Determine controller gains values with operating pressure at MAXIMUM.

4. Increase target rate or machine speed until system reaches the maximum operating pressure.
5. Adjust the rate controller gain value until stable.

Controller gain value at maximum pressure: _____

Test 2 – Duty Cycle 50%

1. Start by setting DynaJet IC7140 duty cycle to **50%**.

Test 2A – Minimum Operating Pressure

Determine controller gains/values with operating pressure at MINIMUM.

2. Reduce target rate or machine speed until system reaches the minimum operating pressure.
3. Adjust the rate controller gain value until stable.

Controller gain value at minimum pressure: _____

Test 2B – Maximum Operating Pressure

Determine controller gains/values with operating pressure at MAXIMUM.

4. Increase target rate or machine speed until system reaches the maximum operating pressure.
5. Adjust the rate controller gain value until stable.

Controller gain value at maximum pressure: _____

Test 3 – Duty Cycle “Minimum Duty Cycle”

1. Start by setting DynaJet IC7140 duty cycle set to “Minimum Duty Cycle” value (default is **30%**)

Test 3A – Minimum Operating Pressure

Determine controller gains/values with operating pressure at MINIMUM.

2. Reduce target rate or machine speed until system reaches the minimum operating pressure.
3. Adjust the rate controller gain value until stable.

Controller gain value at minimum pressure: _____

Test 3B – Maximum Operating Pressure

Determine controller gains/values with operating pressure at MAXIMUM.

4. Increase target rate or machine speed until system reaches the maximum operating pressure.
5. Adjust the rate controller gain value until stable.

Controller gain value at maximum pressure: _____

NO. 6 CALIBRATE THE DYNAJET IC7140 SYSTEM

The following steps will use Proportional Gain and Derivative Gain to tune the DynaJet System. Proportional Gain will be increased until the system is oscillating across the target pressure then stepped down to stability. Once that is occurring then Derivative Gain will be increased to bring the pressure to target quickly, yet not so high as to introduce oscillation.

- The lower the target droplet size, the higher the Derivative Gain can be set; therefore, tuning needs to be done at highest pressure/smallest droplet size that the machine will typically be operating.
- Speed changes, target droplet size changes or droplet size engagement/disablement will be required for the best tuning possible.
- Target droplet size changes are preferred, but driving the machine is ok.
- Steady speeds are required.

Proportional Gain

Used to settle smaller errors by getting to the target droplet size more quickly and with less noise in the system.

- ◀ Gain Too Low – getting close to the target droplet size will be slow (unable to maintain within 10% of the target droplet size). While the system is trying to reach a target droplet size, the actual pressure will slowly get closer to the target to avoid passing the target before reaching a steady-state.
- ◀ Gain Too High – getting close to the target droplet size will be noisy or oscillate around the target droplet size. While the system is trying to settle on a target droplet size, the actual pressure may pass the target several times before reaching a steady-state.

Figure 3-7: Proportional Gain

Red diamond illustrates stability or noise trying to reach the green target diamond.

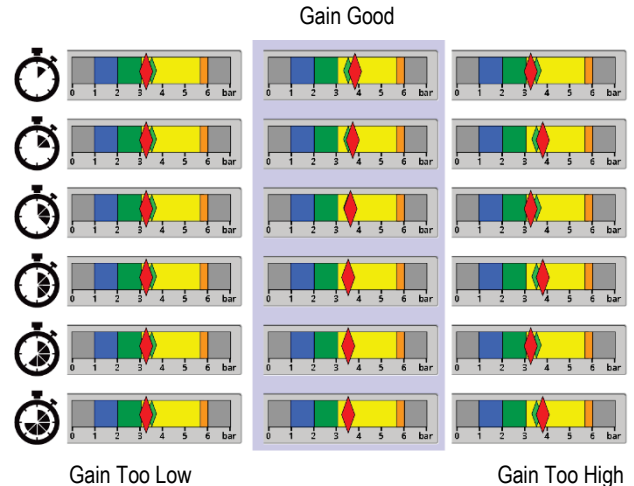

Derivative Gain

Used to settle larger errors by getting to the approximate target droplet size more quickly. For example, if a boom section is turned on, derivative gain then applies a one-time gain. Because the action of the boom on was quick and the rate of change was short, derivative gain is then stronger.

- ◀ Gain Too Low – getting close to the target droplet size will be slow. While the system is trying to reach a target droplet size, the actual pressure will slowly get closer to the target to avoid passing the target before reaching a steady-state. This often occurs when there is a large pressure change on the system such as a droplet size engagement/disablement or dramatic speed change.

- ◀ Gain Too High – getting close to the target droplet size will be slow and cause the system to oscillate extremely rapidly. While the system is trying to settle on a target droplet size, the actual pressure may pass the target several times before reaching a steady-state.

Figure 3-8: Derivative Gain

Red diamond illustrates stability or noise trying to reach the green target diamond.

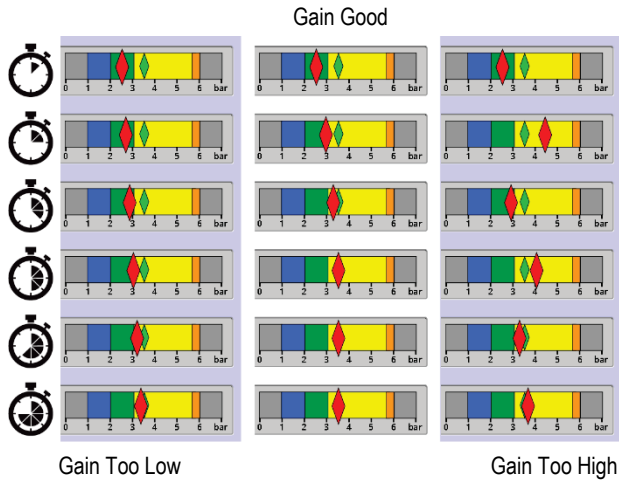

Select Gain Preset

Gain Preset Setup establishes up to five (5) presets of proportional/derivative gain combinations. Different combinations may be needed for different nozzle selections.

1. From the Main Setup screen, select **Machine Setup**.
2. Select a Gain Preset.
3. Using the BACK ONE SCREEN KEY, return to the Main setup screen.
4. From the Main setup screen, select **Gain Preset Setup**.
5. Select the same Gain Preset Number as selected above.
6. Set the Derivative Gain Value to **4**.
7. Set the Proportional Gain value to **4**.

Figure 3-9: Gain Preset Selection

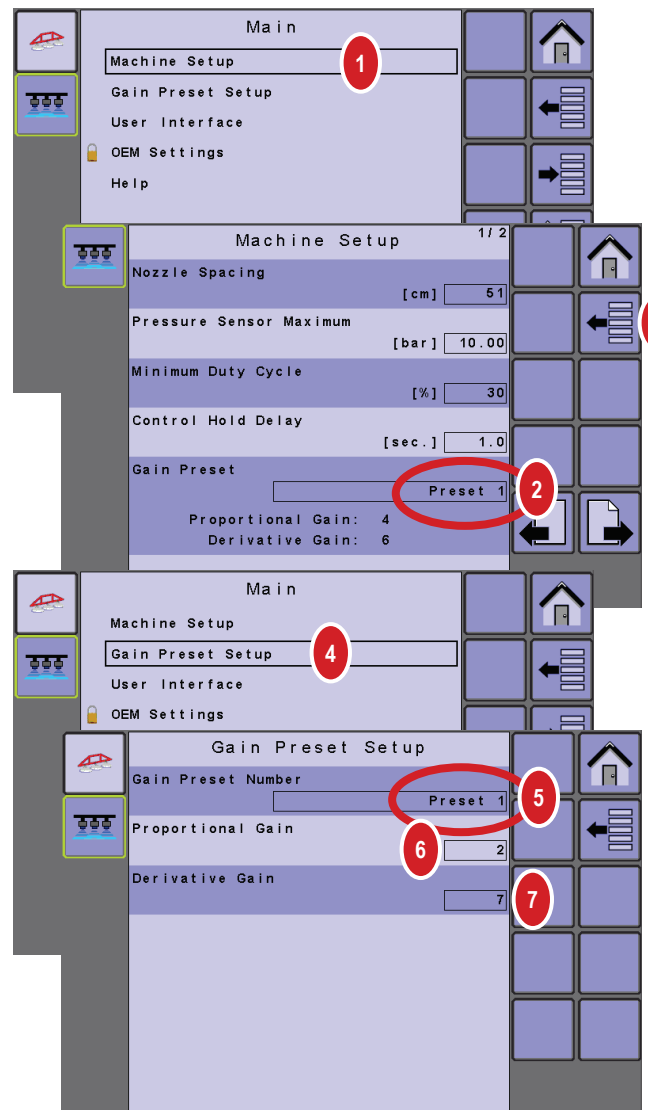

Calibrating the System

The following steps will use the DynaJet IC7140's Proportional Gain and Derivative Gain settings to calibrate the system:

1. Set Operation Mode to Adjustable Droplet Mode.



Adjustable Droplet Mode – Select the intended nozzle and the droplet size range with the option to adjust the target droplet size.

2. Choose the nozzle being used from the Nozzle Favourites screen. When communicating with a rate controller, be sure that both the rate controller and the DynaJet are set to the same nozzle.

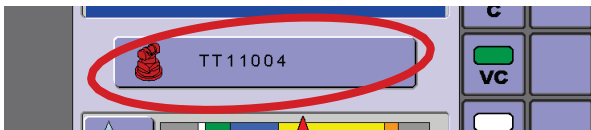

3. Run "Highest Pressure/Smallest Droplet Size" configuration.
4. Notate Proportional Gain and Derivative Gain values for reference with Lower Pressure/Larger Droplet Size verification.
5. Run "Lower Pressure/Larger Droplet Size" verification.

If more than one nozzle size is going to be used on the machine, then using a different Gain Preset, run a test with the same values for Proportional Gain and Derivative Gain for the other nozzles. Always check at the highest pressure/smallest droplet size that will typically be used.

Change the DynaJet control to Manual Mode can assist in trying to isolate oscillations by determine if an oscillation in the system is being caused by the rate controller of the DynaJet. If oscillations continue while in Manual Mode, the issue may be with rate controller.

If oscillations are seen in Manual Mode due to the rate controller, adjustments to the rate controller's Control Hold Delay may need to be made.

- ◀ A Control Hold Delay set (numerically) too high will be slow to adjust pressure and may cause the control to have to make a second adjustment to the flow.
- ◀ A Control Hold Delay set (numerically) too low will react too quickly to dynamic changes on the machine and may start the pressure adjustment in the wrong direction (which will also make the control slow to get to rate)

Highest Pressure/Smallest Droplet Size

Calibrate Proportional Gain

1. On the Operation screen, using the DROPLET SIZE ENGAGEMENT/ DISENGAGEMENT KEYS, choose the highest pressure/smallest droplet size that will typically be used by disabling Droplet Size Keys.

Example:

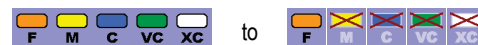

2. Run the system and view on the DynaJet IC7140 the Current Nozzle Pressure diamond on the Nozzle Gauge when changing speed.

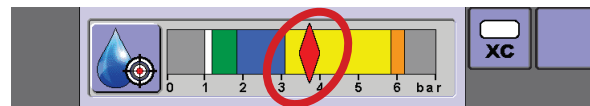

3. Increase the Proportional gain until system is oscillating across the target pressure then stepped down to stability. Most machines operate with a setting between 4 to 12 for Proportional gain.

Proportional Gain value at highest pressure/smallest droplet size: _____

Calibrate Derivative Gain

4. Using the same speed changes as before, view the Current Nozzle Pressure diamond on the Nozzle Gauge when changing speed

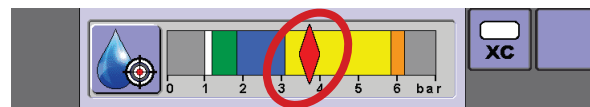

5. Begin increasing Derivative gain to see how quickly you can get the pressure to get to target without inducing an oscillation. Most machines operate with a setting between 4 to 8 for Derivative gain.

Derivative Gain value at highest pressure/smallest droplet size: _____

Lower Pressure/Larger Droplet Size

6. After Proportional Gain and Derivative Gain have been set, using the Droplet Size Keys, choose a lower pressure/larger droplet size that will typically be used by disabling Droplet Size Keys.

Example:

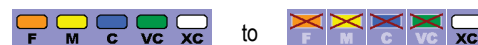

7. Run the system using the same speed changes and view on the DynaJet IC7140 the Current Nozzle Pressure diamond on the Nozzle Gauge when changing speed.

Typically, the settings will not have to be changed for the lower pressure applications.

CHAPTER 4 - HOME SCREEN



The Home screen gives access to the DynaJet IC7140's available functions.

NOTE: Information on the ECU will vary depending on the parameters set by the user and the OEM.

Figure 4-1: Home Screen

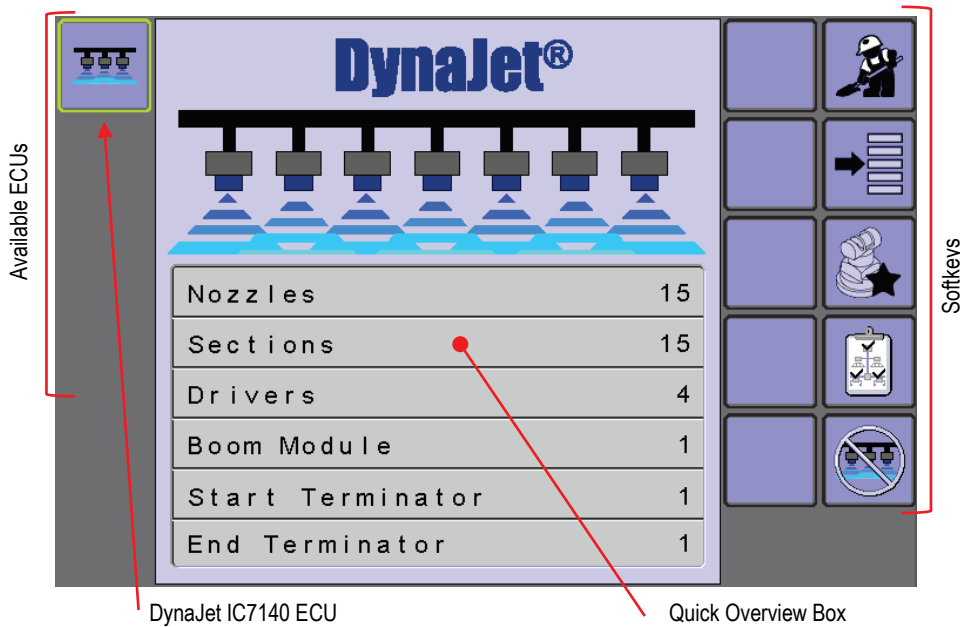

Home Screen Options

- ▶ **Quick Overview Box** – Displays a quick overview of the state of the systems components. When a rate controller is on the system and communicating, displaying some information is not required.
- ▶ **Available ECUs** – Use to navigate between systems currently available on your UT. The highlighted ECU icon indicates the ISOBUS system component that is in focus.

NOTE: Icons vary depending on systems available components.



DynaJet IC7140 ECU – Press to access the DynaJet IC7140 system.

A progress bar may be shown on the icon during start up while the system loads and communicates with all components.



While DynaJet is in Disengage Mode, ECU icon will change to alert user that the system is in Disengage Mode.

Use these softkeys to assist in operation:



Operation Mode – Press to access the Operation screen of the DynaJet IC7140 system



Operation Mode Not Available – Shown when the Operation screen is not available due to an error



Main Setup Menu – Press to access the main setup menu to input various control settings



Nozzle Favourites – Press to access the Nozzle Favourites screen to preset up to five (5) nozzles and select the current nozzle



System Overview – Press to access the System Overview screen to locate any problems as well as give information on selected drivers or solenoids



Disengage Mode – Press to activate Disengage Mode.



Disengage Mode Not Available – Shown when Disengage Mode is not available due to an active application state such as Master Switch On or one or more sections on.

Accessing the Home Screen

The Home screen can be accessed using the Home key from any screen.

1. From any screen, press the HOME KEY.

Figure 4-2: Home Screen – from Main Setup Screen

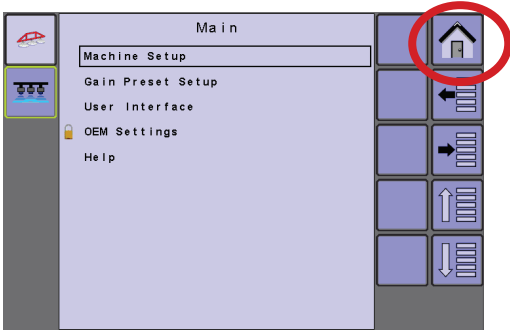

Figure 4-3: Home Screen – from Operation Screen

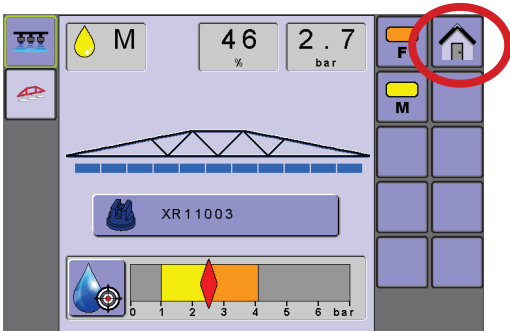
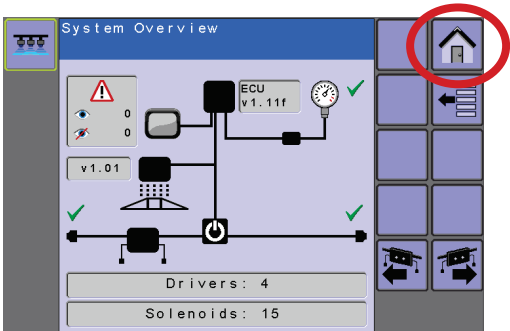

Figure 4-4: Home Screen – from System Overview Screen



Quick Overview Box

The Quick Overview section on the Home screen displays several values to alert the user of the state of the system. Information displayed in the quick overview will vary depending on rate controller communication availability.

Use the SYSTEM OVERVIEW KEY to get more details on the system components. See the “SYSTEM OVERVIEW” chapter for more details.

Rate Controller Communications

The following set of information will inform the user of the current implement status and signify any issues by displaying an alert.

- Nozzles – number of nozzles
- Sections – number of sections
- Drivers– number of drivers
- Boom Module – number of boom modules
- Start Terminator – number of start terminators
- End Terminator – number of end terminators

Figure 4-5: Quick Overview without Rate Controller

Nozzles	15
Sections	15
Drivers	4
Boom Module	1
Start Terminator	1
End Terminator	1

Rate Controller Communications

The following set of information is what is available with a rate controller to inform the user of the current implement status and signify any issues by displaying an alert.

- Nozzles – number of nozzles
- Drivers– number of drivers
- Start Terminator – number of start terminators
- End Terminator – number of end terminators

Figure 4-6: Quick Overview with Rate Controller

Nozzles	32
Drivers	4
Start Terminator	1
End Terminator	1

Errors

Initialisation errors and lost communication appear on the Home screen to alert the operator of certain issues and prevent the console from entering operation mode until rectified.

- Nozzles – the number of nozzles on the sprayer does not match the DynaJet IC7140
- Drivers – at least one driver is not present on the sensor BUS
- Boom Module – communication to a BIM has been lost
- Start Terminator – the start terminator not detected
- End Terminator – the end terminator not detected

Figure 4-7: Quick Overview Error Example

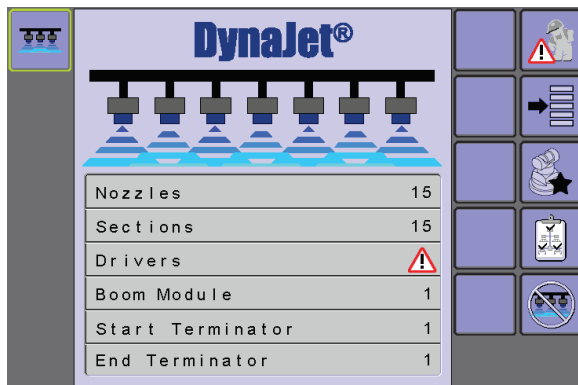

Use the SYSTEM OVERVIEW KEY to get more details on the offending system component which is displayed in red with an error icon.

Figure 4-8: System Overview Error Example

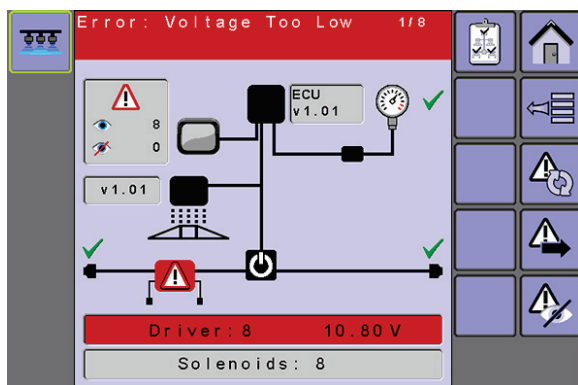

See the "SYSTEM OVERVIEW" chapter or "APPENDIX B – TROUBLESHOOTING GUIDE" for more details.

Disengage Mode

While in Disengage mode, all DynaJet functions are locked off and cannot be activated nor accessed. Rate controller functions may continue after properly shutting off any application and entering Disengage Mode. Disengage mode will display the current speed.

Activating Disengage Mode

1. From the Home Screen, press the DISENGAGE MODE KEY.

Deactivating Disengage Mode

1. From the Disengage Screen, press the HOME KEY.

Figure 5-1: Disengage Screen

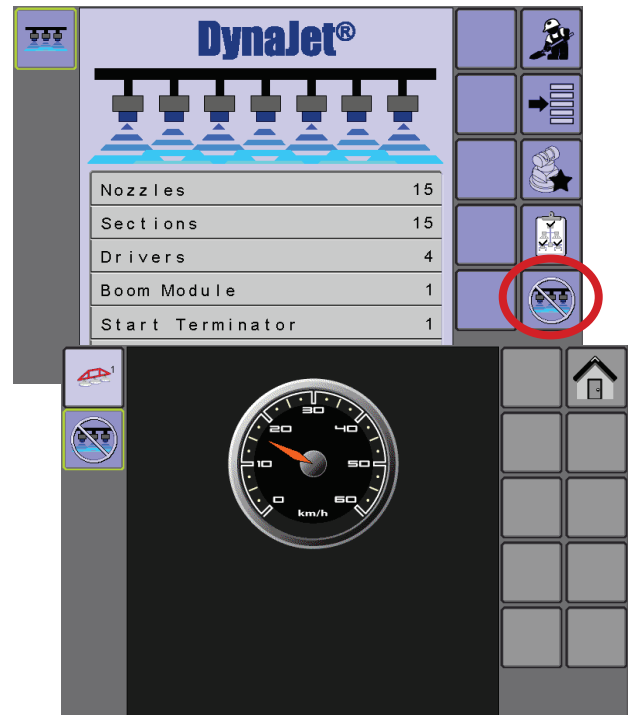

CHAPTER 5 - SETUP

Set up the DynaJet through options in both the Main Setup Menu and Nozzle Favorites screen. TeeJet defaults and ranges are included on the User Settings Log included in the Appendix. Defaults and ranges established by an OEM may vary.

Main Setup Menu

The main setup menu accesses machine setup, gain presets, user interface options, OEM options, and the help menu including diagnostics screens.

Figure 5-1: Main Setup Screen

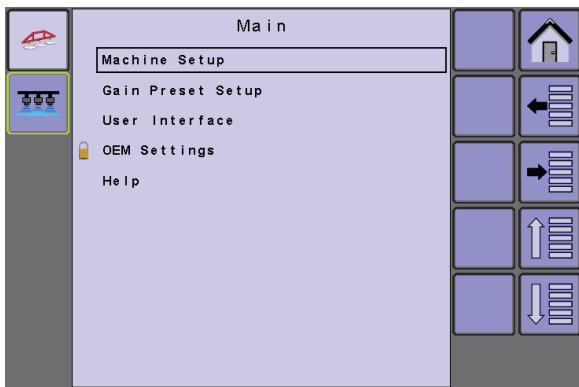

Accessing the Main Setup Screen

The Main Setup Screen can be accessed from the Home screen.

1. From the Home Screen, press the MAIN SETUP SCREEN KEY.

Figure 5-2: Main Setup Screen – from Home Screen

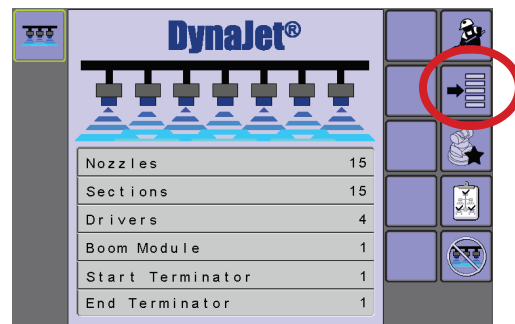

Nozzle Favourites Screen

The Nozzle Favourites screen displays the current selected nozzle for determining droplet size information and provides five (5) preset settings for quick recall.

Figure 5-3: Nozzle Favourites



Accessing the Nozzle Favourites Screen

The Nozzle Favourites screen can be accessed from the Home screen or the Operation screen.

1. From the Home Screen, press the NOZZLE FAVOURITES KEY.

Figure 5-4: Nozzle Favourites – from Home Screen

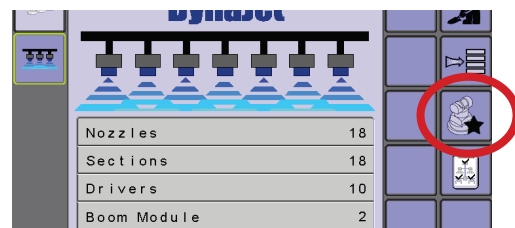

1. From the Operation Screen, press the CURRENT NOZZLE BUTTON.

Figure 5-5: Nozzle Favourites – from Operation Screen

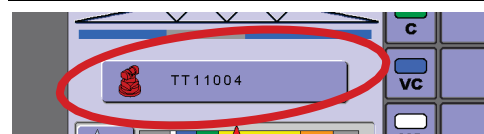

MAIN SETTINGS MENU

NOTE: The menu structure on your display might vary from the one displayed in this User Manual depending on the UT being used and the OEM settings. This user manual will display all possible options.

Figure 5-6: Main Setup Screen Overview

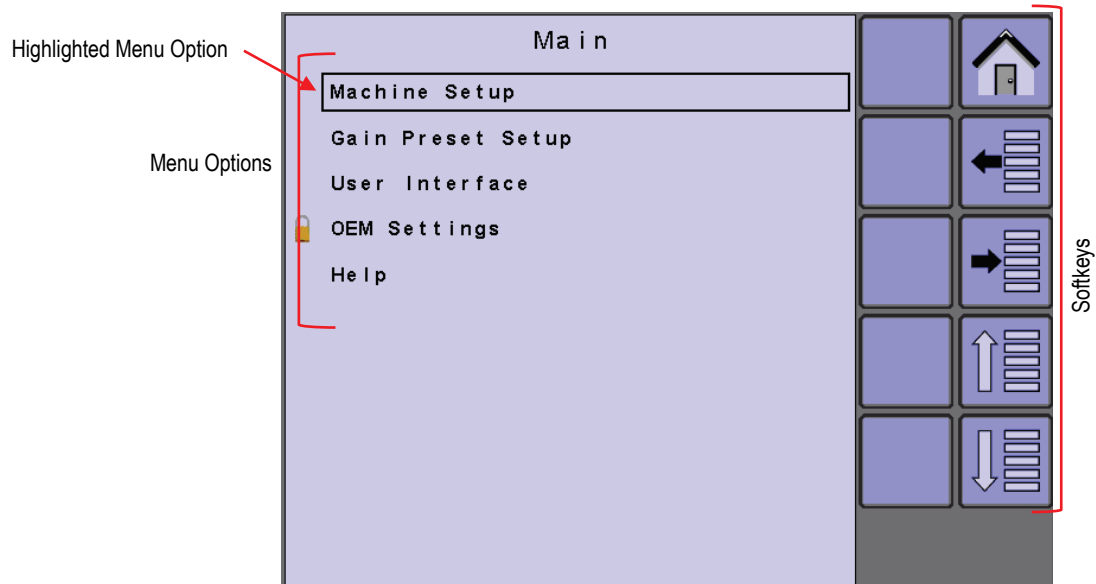

Main Setup Overview Options

- ▶ Machine Setup – used to configure machine settings
- ▶ Gain Preset Setup – used to configure gain preset combinations
- ▶ User Interface – allows the operator to select the section beep setting and preferred universal terminal (UT)
- ▶ OEM Settings – used to configure additional machine settings (menu is password protected and the settings in this menu are directly related to the fitted OEM equipment)
- ▼ Help – allows the operator to view system information
 - ▶ About – provides information on the console and modules
 - ▶ System Overview – used to display an overview of select system elements to assist in troubleshooting and diagnosing any operating issues of the system and booms
 - ▶ UT Data Diagnostics – The UT Data Diagnostics screen provides information regarding the virtual terminal controller
 - ▶ Gyroscope Diagnostics – The Gyroscope Diagnostics screen provides information regarding the gyroscope

Use these softkeys to assist in establishing settings:



Home – Press to go to the Home screen.



Back One Screen – Press to return to the Home screen.



Forward One Screen – Press to go to the highlighted menu option's screen.



Up One Option – Press to highlight the next option up on the menu.



Down One Option – Press to highlight the next option down on the menu.

Machine Setup

Machine Setup is used to configure machine settings. When a rate controller is on the system with readable communications, some settings are controlled by the rate controller.

WARNING! With each nozzle change or when nozzles are replaced, a system calibration (steps NO. 5 CALIBRATE THE RATE CONTROLLER REGULATION and NO. 6 CALIBRATE THE DYNAJET IC7140 SYSTEM in the "INITIAL START-UP & CALIBRATIONS" chapter) must be completed before attempted operation. These configurations may affect Gain settings. Failure to properly configure and calibrate the system will result in sub-standard performance.

1. From the Main Setup screen, select **Machine Setup**.

Figure 5-7: Machine Setup

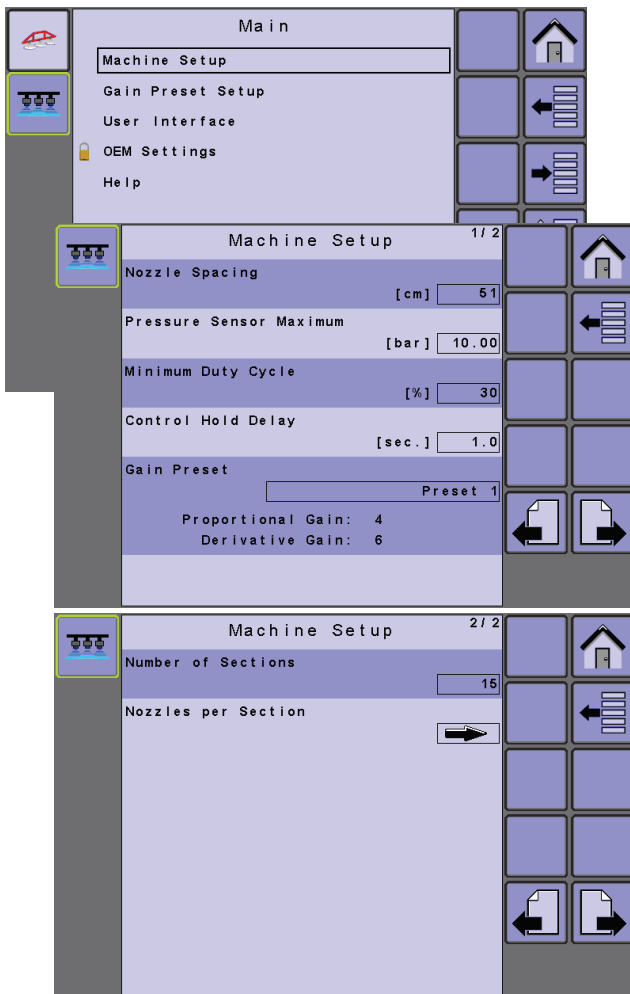
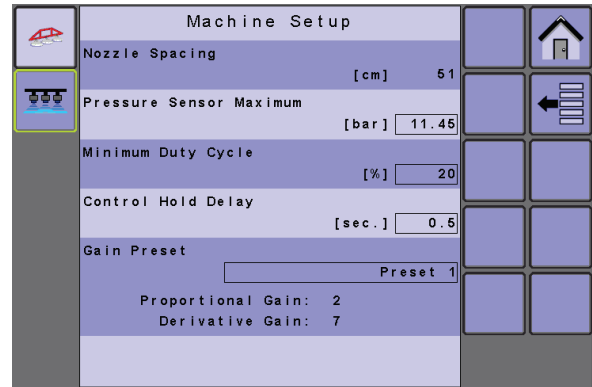

Figure 5-8: Machine Setup with Rate Controller



Nozzle Spacing

Sets the spacing measurement between nozzles.

NOTE: To prevent the application rate from being wrong, the nozzle spacing multiplied by the number of nozzles must match the section width.

Pressure Sensor Maximum

Sets and verifies the Pressure Sensor Maximum value by looking at the maximum pressure printed on the pressure sensor.

Minimum Duty Cycle

Sets the Minimum Duty Cycle percentage to which DynaJet will control.

Control Hold Delay

When any boom switch changes state, DynaJet will not make control adjustments for the specified time period.

Gain Preset

Select one of five (5) preset gain combinations. Preset gain combinations are determined under the Gain Preset Setup menu. This setting will set the same for all operation modes and selected nozzles.

Number of Sections

Sets the number of boom sections. Number of sections will not be available when set by a rate controller.

Nozzles per Section

Sets the number of nozzle locations for each boom section. Sections are numbered from left to right while facing in the machine's forward direction. Number of nozzle locations will not be available when set by a rate controller.

1. Select NOZZLES PER SECTION ARROW.
2. Establish the number of nozzles for each available section.

Figure 5-9: Nozzles per Section

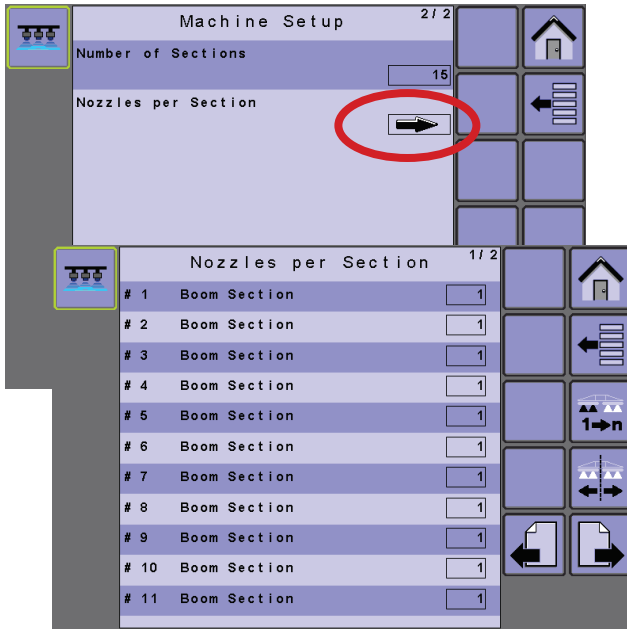

Use these softkeys to assist in establishing settings:



Equal Number of Nozzles – Press to set all sections to have the same number of nozzles as the value set for Section 1.



Symmetric Sections – Press to establish if sections are paired and therefore share the same nozzles per section. Sections on right will be mirrored with sections on left.

The total number of nozzles is what is displayed on the Operation Screen. Displaying of individual dynamic boxes for each nozzle will be limited by the size of the UT screen. Once the maximum number of nozzles has been met, the spaces between nozzles will disappear, but individual nozzle status will still be shown as on (blue) or off (grey).

Figure 5-10: Visual Under Maximum Individual Nozzles

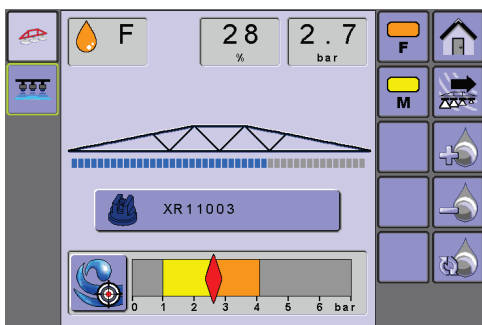
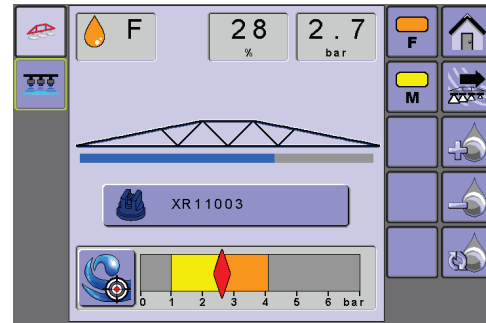

Figure 5-11: Visual Over Maximum Individual Nozzles



Gain Preset Setup

Gain Preset Setup establishes up to five (5) presets of proportional/derivative gain combinations.

WARNING! With each nozzle change or when nozzles are replaced, a system calibration (steps NO. 5 CALIBRATE THE RATE CONTROLLER REGULATION and NO. 6 CALIBRATE THE DYNAJET IC7140 SYSTEM in the "INITIAL START-UP & CALIBRATIONS" chapter) must be completed before attempted operation. These configurations may affect Gain settings. Failure to properly configure and calibrate the system will result in sub-standard performance.

1. From the Main setup screen, select **Gain Preset Setup**.
2. Select a Gain Preset Number.
3. Set the Derivative Gain Value.
4. Set the Proportional Gain value.

To select the active gain preset combination, go to the Machine Setup menu.

Figure 5-12: Gain Preset Setup

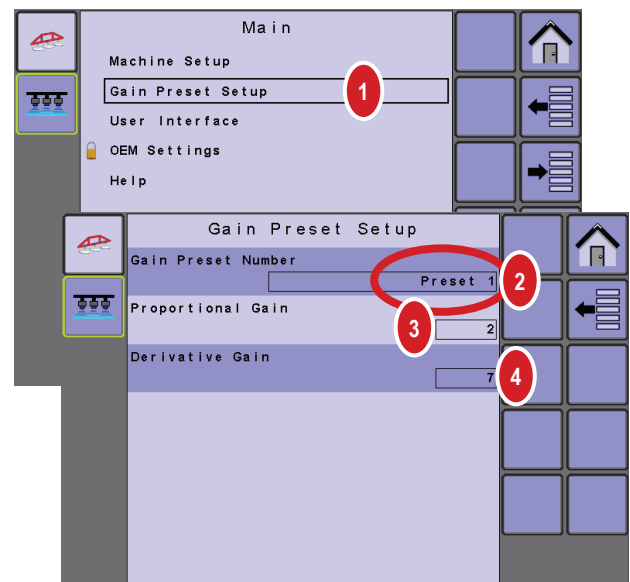

Gain Preset Number

Each one of up to five (5) gain presets can be selected to establish different sets of gain combinations.

CAUTION: Always check that the intended preset number is selected before making changes to the Proportional Gain or Derivative Gain.

Proportional Gain

Used to settle smaller errors by getting to the target droplet size more quickly and with less noise in the system.

- ◀ Gain Too Low – getting close to the target droplet size will be slow (unable to maintain within 10% of the target droplet size). While the system is trying to reach a target droplet size, the actual pressure will slowly get closer to the target to avoid passing the target before reaching a steady-state.
- ◀ Gain Too High – getting close to the target droplet size will be noisy or oscillate around the target droplet size. While the system is trying to settle on a target droplet size, the actual pressure may pass the target several times before reaching a steady-state.

Figure 5-13: Proportional Gain

Red diamond illustrates stability or noise trying to reach the green target diamond.

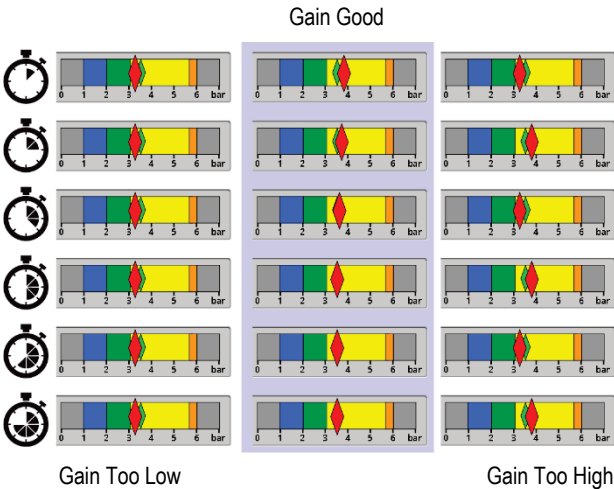

Derivative Gain

Used to settle larger errors by getting to the approximate target droplet size more quickly. For example, if a boom section is turned on, derivative gain then applies a one-time gain. Because the action of the boom on was quick and the rate of change was short, derivative gain is then stronger.

- ◀ Gain Too Low – getting close to the target droplet size will be slow. While the system is trying to reach a target droplet size, the actual pressure will slowly get closer to the target to avoid passing the target before reaching a steady-state. This often occurs when there is a large pressure change on the system such as a droplet size engagement/disabling or dramatic speed change.
- ◀ Gain Too High – getting close to the target droplet size will be slow and cause the system to oscillate extremely rapidly. While the system is trying to settle on a target droplet size, the actual pressure may pass the target several times before reaching a steady-state.

Figure 5-14: Derivative Gain

Red diamond illustrates stability or noise trying to reach the green target diamond.

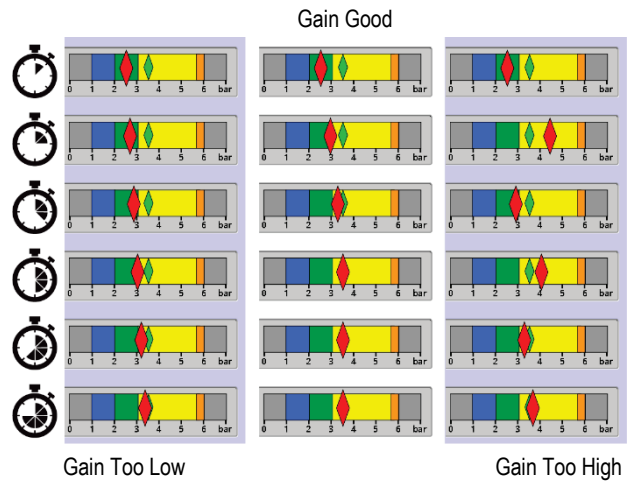

User Interface

User Interface settings allow the operator to set the preferred UT, boom section beep, and Turn Compensation Visual.

1. From the Main setup screen, select **User Interface**.

Figure 5-15: User Interface

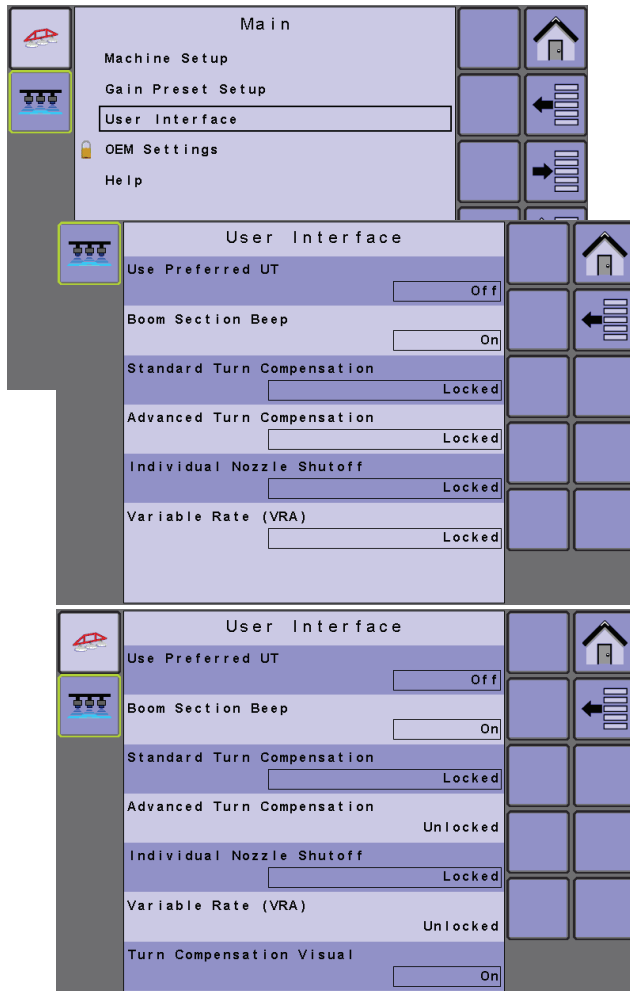

Use Preferred UT

Sets the universal terminal (UT) preference.

- ▶ If more than one UT is available on the ISOBUS CAN,
 - Select **On** to use the current UT
 - Select **Off** to use a different UT on the ISOBUS CAN

NOTE: If all UTs are set to “Off”, the system will arbitrarily select which UT to use.

- ▶ If only one UT is available, select **Off**

NOTE: This should always be set to “Off” unless another UT is on the CAN bus.

Boom Section Beep

Enables/disables beep when a boom section is turned on or off.

Standard Turn Compensation Unlock

When unlocked, makes standard turn compensation available on the Operation screen. Standard Turn Compensation allows for turn compensated application on this console. With standard turn compensation, average pressure is calculated from the active sections width then centered over the active sections. If Advanced Turn Compensation is unlocked, Standard Turn Compensation Unlock is not available.

Contact an authorized TeeJet Technologies local dealer for unlock code availability.

See bulletin 98-01563 Standard Turn Compensation Unlock for unlock instructions.

Advanced Turn Compensation Unlock

When unlocked and used with a compatible rate controller, makes advanced turn compensation available on the Operation screen. Advanced Turn Compensation allows for turn compensated application on this console when used with a compatible rate controller. With advanced turn compensation, average pressure is calculated from the active width but is centered over all sections (active or inactive). If Advanced Turn Compensation is unlocked, Standard Turn Compensation Unlock is not available.

Contact an authorized TeeJet Technologies local dealer for unlock code availability.

See bulletin 98-01564 Advanced Turn Compensation Unlock for unlock instructions.

Individual Nozzle Shutoff Unlock

When unlocked and used with a compatible rate controller, makes Individual Nozzle Shutoff available. Individual Nozzle Shutoff allows for up to 100 individual sections (allowing one nozzle per section) on this console when used with a compatible rate controller. Individual Nozzle Shutoff is required for rate controllers configured with more than 30 sections.

Contact an authorized TeeJet Technologies local dealer for unlock code availability.

See bulletin 98-0155 Individual Nozzle Shutoff Unlock for unlock instructions.

Variable Rate (VRA) Unlock

When unlocked and used with a compatible rate controller, makes Variable Rate (VRA) available. Variable Rate (VRA) allows for more than one rate across the boom at the same time on this console when used with a compatible rate controller.

Contact an authorized TeeJet Technologies local dealer for unlock code availability.

See bulletin 98-01566 Variable Rate (VRA) Unlock for unlock instructions.

Turn Compensation Visual

Enables/disables the turn compensation visual graph on the operation screens. Only available when Standard or Advanced Turn Compensation is unlocked.

Figure 5-16: Turn Compensation Visual on Operation Screen

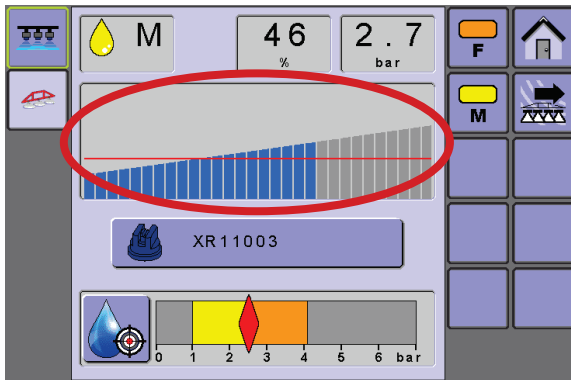
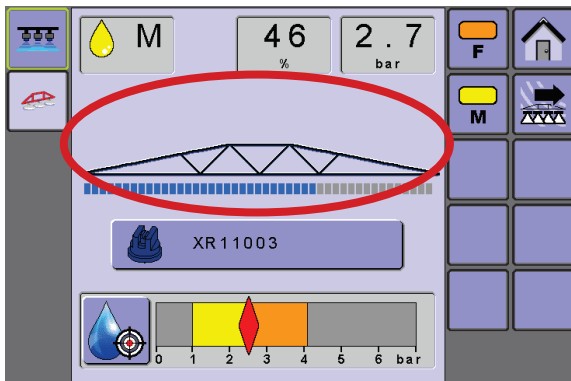

Figure 5-17: Turn Compensation Visual Off



OEM Settings

OEM Settings are used to configure additional controller settings. The OEM Settings menu is password protected and the settings in this menu are directly related to the fitted OEM equipment. Contact customer service or a local dealer for questions and service assistance.

- PWM Frequency
- On Pulse Duration.
- Hold Current Frequency Adjustment
- Hold Current Duty Cycle
- Phase Offset
- Jump Point
- Maximum Duty Cycle
- PWM Off Time
- Low Voltage Limit
- High Voltage Limit
- Low Amps Limit
- High Amps Limit
- High Pressure Alarm
- Droplet Size Damping
- ECU Orientation
- Regulation Base
- Solenoid Error State
- Solenoid Disengage State

Figure 5-18: OEM Settings

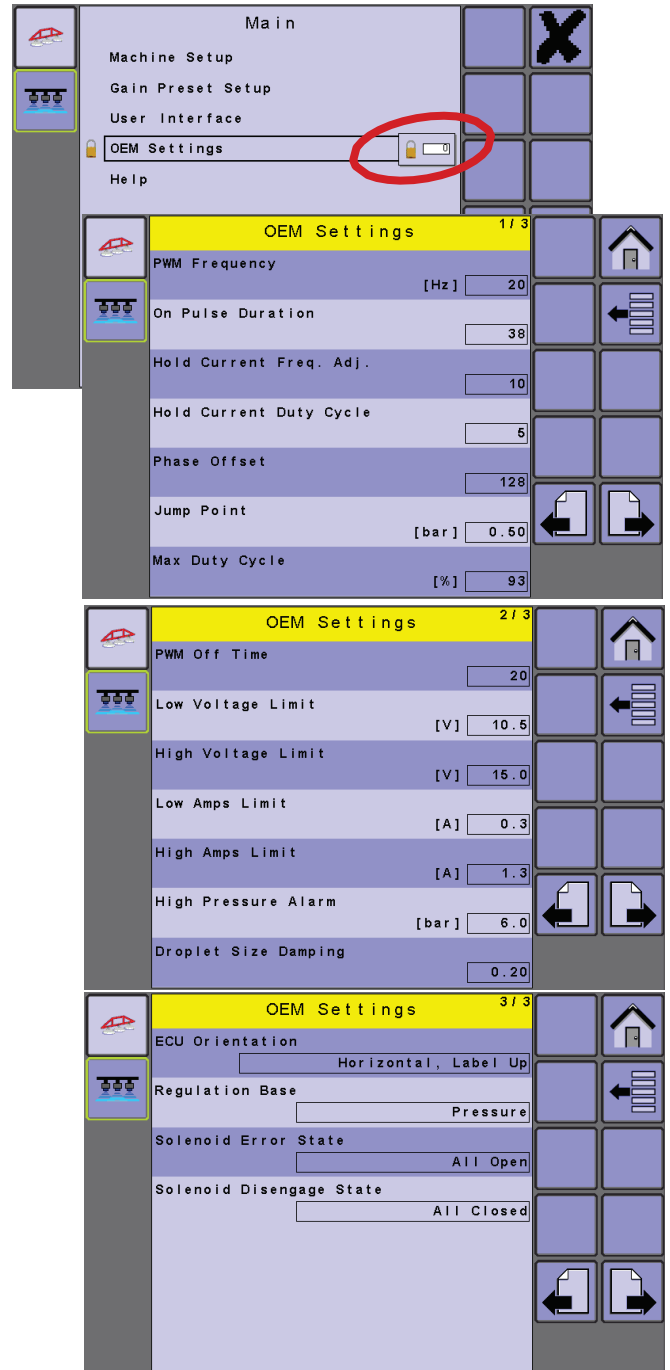

Help

The Help menu allows the operator to view system information, UT Diagnostics and Gyroscope Diagnostics; and enter the System Overview.

1. From the Main setup screen, select **Help**.
2. Select from:
 - ▶ About – provides information on the console and modules
 - ▶ System Overview – used to display an overview of selected system elements to assist in troubleshooting and diagnosing any operating issues of the system and booms
 - ▶ UT Data Diagnostics – provides information regarding the universal terminal
 - ▶ Gyroscope Diagnostics – provides information regarding the gyroscope

Figure 5-19: Help

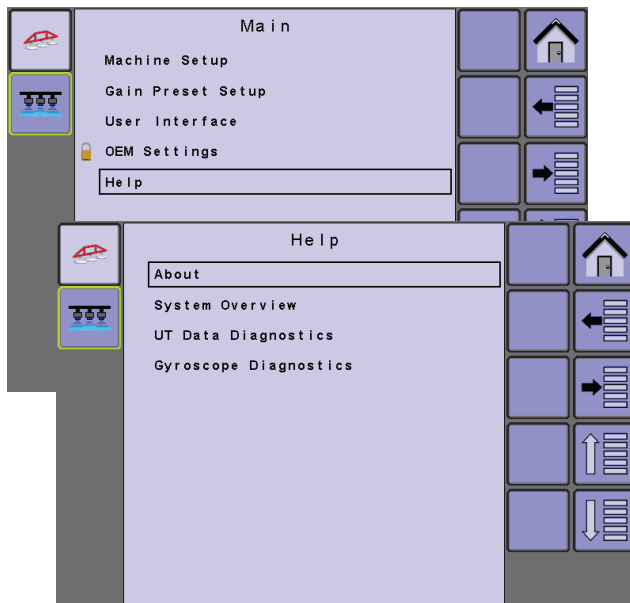

About

The About screen displays version or serial number data for all modules found on the DynaJet IC7140 system.

- DynaJet IC7140 Software Version
- ECU Board Serial Number
- BUS ID ISO Number
- ISO 11783 OEM Name
- ISO 11783 Manufacturer Code

Figure 5-20: About

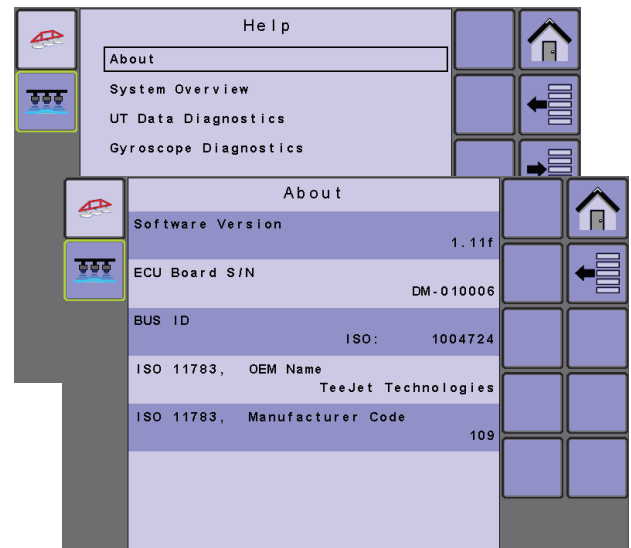

System Overview

Displays system graphically to help the operator locate any problems as well as give information on selected drivers or solenoids.

See the "SYSTEM OVERVIEW" chapter for details.

Figure 5-21: System Overview

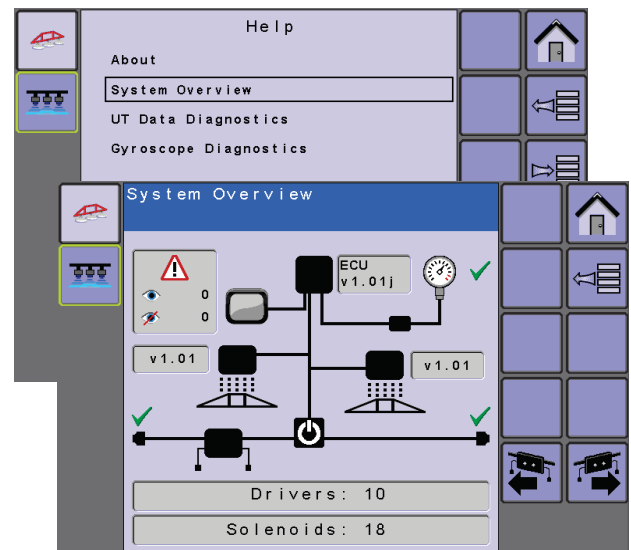

Use these softkeys to navigate through the drivers and solenoids:



Next Driver – Press to access the next driver on the next screen.



Previous Driver – Press to access the previous driver on the previous screen.



Next Solenoid – Press to view the next solenoid on the selected driver.

UT Data Diagnostics

Provides information regarding the universal terminal.

- UT and ECU Address – the address the UT has acquired on the BUS
- Part 6 Version and Status
- Softkey Size – displays softkey size in pixels
- Virtual Number – the total number of possible softkeys.
- Physical Number – number of softkeys able to be shown at one time in the side menu
- Font – define Small, Large, and Attributes
- Colour – indicates the colour scheme used on the system
- HW – hardware
- Datamask Size – indicates the screen size in pixels

Figure 5-22: UT Data Diagnostics

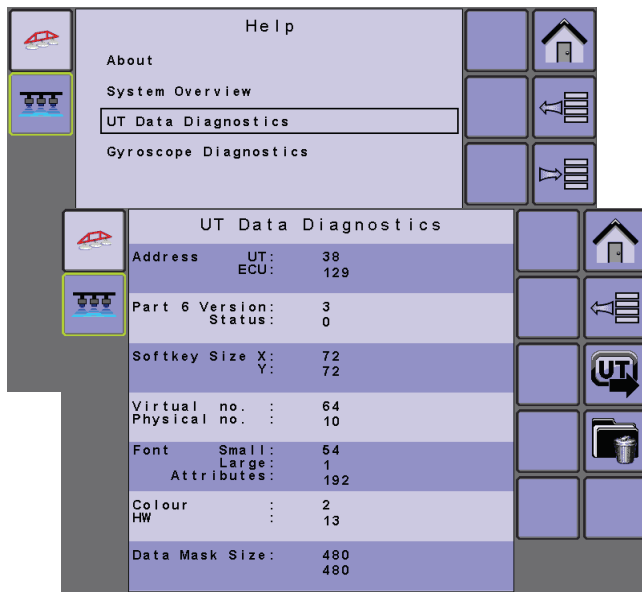

Use these softkeys to change UTs or delete object pools:



Next UT – Press to switch between terminals/controllers when more than one is used.



Delete Object Pools – Press to delete saved information on the UT and force the UT to upload all information from the controller on the next power cycle.

Gyroscope Diagnostics

Provides information regarding the gyroscope.

- Orientation
 - Horizontal, Label Up
 - Horizontal, Label Down
 - Vertical, Connectors Up
 - Vertical, Connectors Down
 - Vertical, Left Edge Up
 - Vertical, Right Edge Up
- X Angle/Pitch - This is the front to back rotation of the DynaJet IC7140 ECU as compared to the vehicle. How many degrees it must be rotated from the Base Orientation position [X: Front, Y: Right] to match the actual orientation on the vehicle.
- Y Angle/Roll - This is the side to side rotation of the DynaJet IC7140 ECU as compared to the vehicle. How many degrees it must be rotated from the Base Orientation position [X: Front, Y: Right] to match the actual orientation on the vehicle.
- Z Angle/Yaw - This is the rotation of the DynaJet IC7140 ECU compared to the vehicle looking down from the top. How many degrees it must be rotated from the Base Orientation position [X: Front, Y: Right] to match the actual orientation on the vehicle.

Figure 5-23: Gyroscope Diagnostics

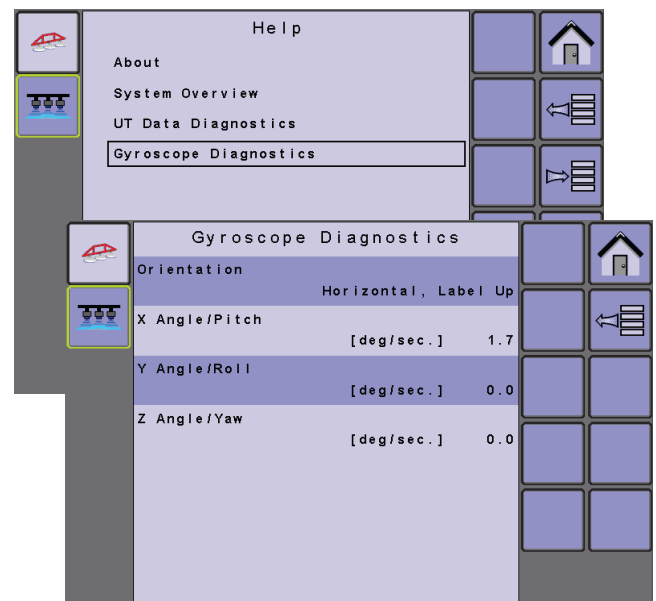

NOZZLE FAVOURITES

Figure 5-24: Nozzle Favourites Screen



System Overview Options

- ▶ Nozzle Presets – Use to select one of the up to five (5) nozzles to be the current nozzle for determining droplet size information
NOTE: When a rate controller is also on the system, the nozzle selected must match that which is selected on the rate controller.
- ▶ Add Nozzle Button – Press to go to the Nozzle Selection screen to specify which nozzle should be assigned to the associated Nozzle Preset button.

WARNING! With each nozzle change or when nozzles are replaced, a system calibration (steps NO. 5 CALIBRATE THE RATE CONTROLLER REGULATION and NO. 6 CALIBRATE THE DYNAJET IC7140 SYSTEM in the "INITIAL START-UP & CALIBRATIONS" chapter) must be completed before attempted operation. These configurations may affect Gain settings. Failure to properly configure and calibrate the system will result in sub-standard performance.

Use these softkeys to assist in establishing settings:



Home – Press to go to the Home screen.



Back One Screen – Press to return to the Home screen or Operation Screen.

Non-Touchscreen UT Options

When using a UT that does not have a touchscreen, screen options will be available as additional softkeys not illustrated in the examples in this manual. Use these softkeys to navigate through the options:



Up One Option – Use to highlight the next nozzle location up on the menu.



Down One Option – Use to highlight the next nozzle location down on the menu.



Nozzle Selection Location 1-5 – Use to go to the Nozzle Selection screen to specify which nozzle should be assigned to nozzle location 1

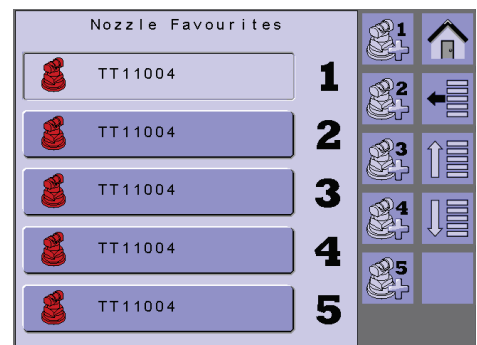

Nozzle Presets

Nozzle presets allow saving of up to five nozzles for quick recall. The selected current nozzle is used to determine droplet size information.

To set or change a nozzle favourite:

1. Next to the location of the Nozzle Preset button to be changed, press the ADD NOZZLE BUTTON.
2. Select a nozzle series.
3. Select a nozzle capacity from the series selected.

Figure 5-25: Add Nozzle

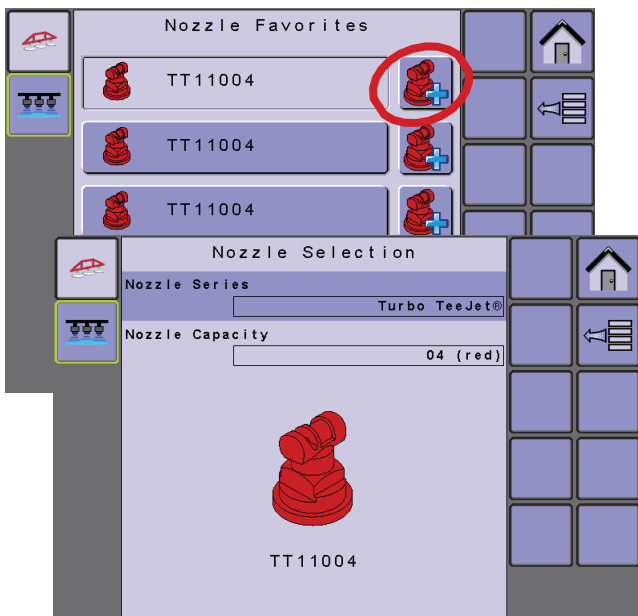

Figure 5-26: Nozzle Sizes and Associated Colours

Established nozzle capacities and colours			
Size	Colour	Size	Colour
0050	Blue lilac	05	Nut brown
0067	Olive green	06	Signal grey
01	Pure orange	08	Traffic white
015	Traffic green	10	Light blue
02	Zinc yellow	12	Raspberry red
025	Signal violet	15	Yellow green
03	Gentian blue	20	Graphite black
035	Purple red	30	Beige
04	Flame red		

Current Nozzle Selection

The active nozzle for determining current droplet size information is the selected button. Nozzles must be preset to be available for current nozzle selection.

NOTE: When a rate controller is also on the system, the nozzle selected must match that which is selected on the rate controller.

WARNING! With each nozzle change or when nozzles are replaced, a system calibration (steps NO. 5 CALIBRATE THE RATE CONTROLLER REGULATION and NO. 6 CALIBRATE THE DYNAJET IC7140 SYSTEM in the "INITIAL START-UP & CALIBRATIONS" chapter) must be completed before attempted operation. These configurations may affect Gain settings. Failure to properly configure and calibrate the system will result in sub-standard performance.

To select an active nozzle:

1. Press desired nozzle.

Figure 5-27: Select Current Nozzle



Figure 5-28: Current Nozzle on Operation Screen

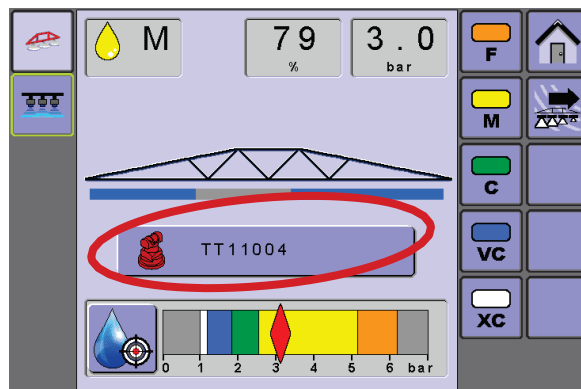

CHAPTER 6 - OPERATION



The operation screen provides the user with important information and controls while operating the system. Information on the Operation screen will vary depending on the parameters set by the user and the OEM. Softkeys on the Operation screen give access to all the functions which are required during operation and will change with the Operation Mode selected.

Figure 6-1: Operation Screen Overview

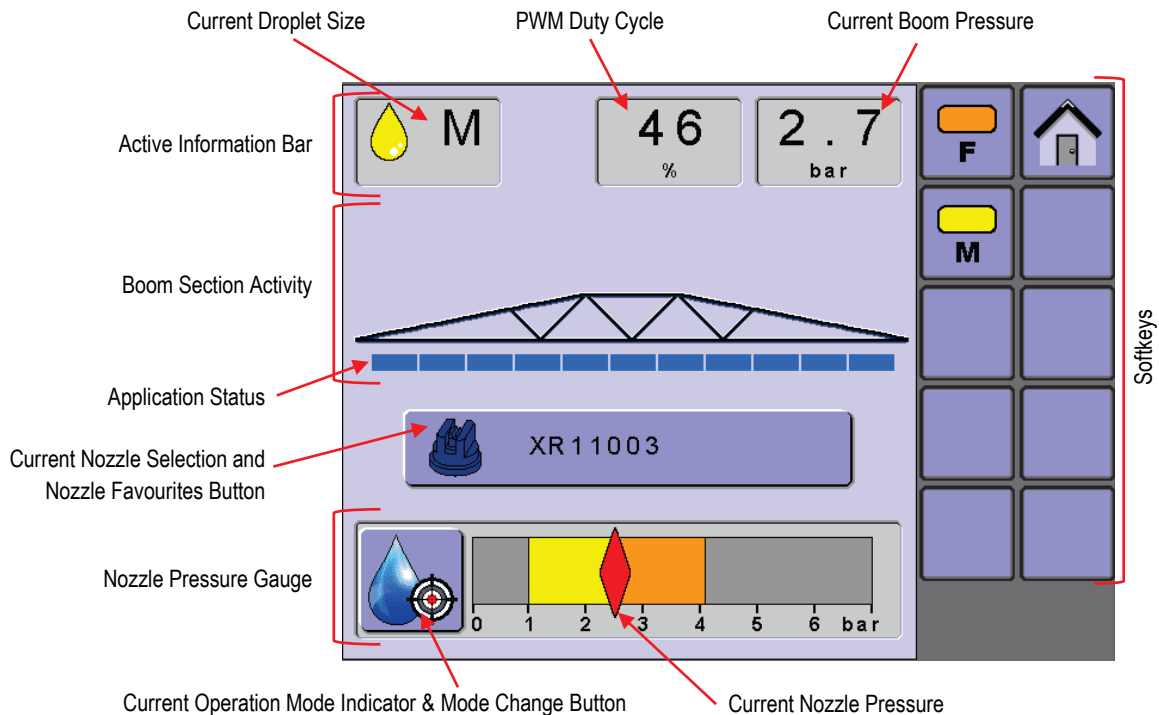

Operation Screen Options

- ▶ **Active Information bar** – Displays the current droplet size using both the appropriate colour droplet icon and size letter code, the current PWM duty cycle and the actual pressure of the boom measured by the pressure sensor
- ▶ **Boom Section Activity** – Displays the on [blue]/off [grey] status of the sections. When turn compensation is unlocked and turn compensation visual is enabled, static boom graphic is replaced with turn compensation graph when turn compensation is active.
- ▶ **Current Nozzle Selection** – Displays the active nozzle for determining current droplet size information and can be used to go to the Nozzle Favorites screen to change the current nozzle or preset additional nozzles
- ▶ **Nozzle Pressure Gauge** – Displays Current Operation Mode Indicator & Mode Change Button, available droplet sizes using the appropriate droplet size colours (disabled sizes are crossed out, when available), the average actual solenoid pressure (red diamond), and target average solenoid pressure (green diamond, when available)

Use these softkeys to assist in operation:



Home – Press to go to the Home screen.



Multiple Pages – Press to toggle between softkey menu lists when more softkeys are available than can be shown on one screen

NOTE: Only available when more than one page is needed.

Accessing the Operation Screen

The Operation screen can be accessed from the Home screen or from an error message.

1. From the Home Screen, press the OPERATION KEY.

Figure 6-2: Operation Screen – from Home Screen

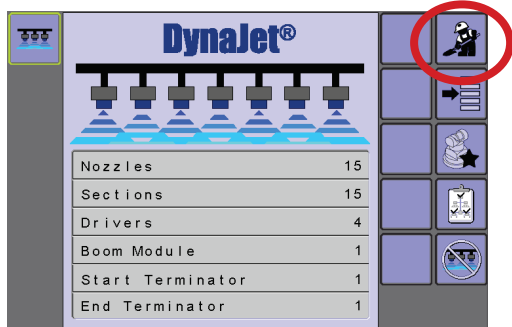

1. From an error message, select OPERATION KEY.

Figure 6-3: Operation Screen – Through an Error Message

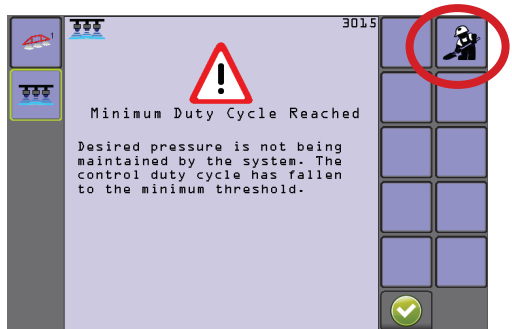

Droplet Size Chart

When choosing a spray nozzle that produces droplet sizes in one of the eight droplet size classification categories, always remember that a single nozzle can produce different droplet size classifications at different pressures. A nozzle might produce medium droplets at low pressures, while producing fine droplets as pressure is increased.

Category	Symbol	Colour code
Extremely fine	XF	Violet
Very fine	VF	Red
Fine	F	Orange
Medium	M	Yellow
Coarse	C	Green
Very coarse	VC	Blue
Extremely coarse	XC	White
Ultra coarse	UC	Black

NOTE: Droplet size classifications are based on BCPC specifications and in accordance with ASABE Standard S572.1 at the date of printing. Classifications are subject to change.

OPERATION MODES

There are three types of Operation Modes:



Manual Mode – Select the intended nozzle and the target PWM Duty Cycle Percentage.



Droplet Mode – Select the intended nozzle and the target droplet size range.

NOTE: Droplet Mode may not be available with all system configurations.



Adjustable Droplet Mode – Select the intended nozzle and the droplet size range with the option to adjust the target droplet size.

NOTE: Many factors including but not limited to application rate, material density, speed, nozzle model/size/spacing may limit the ability of DynaJet IC7140 to meet the control target.

To select an operation mode:

1. Press the CURRENT OPERATION MODE INDICATOR & MODE CHANGE BUTTON on the Nozzle Pressure Gauge. Modes will toggle from Manual Mode to Droplet Mode to Adjustable Droplet Mode.

Manual Mode

Select the intended nozzle and the target PWM Duty Cycle Percentage. The system will calculate and display the droplet sizes for the nozzle selected. DynaJet IC7140 will control to the target Duty Cycle Percentage.

Figure 6-4: Operation Screen – Manual Mode

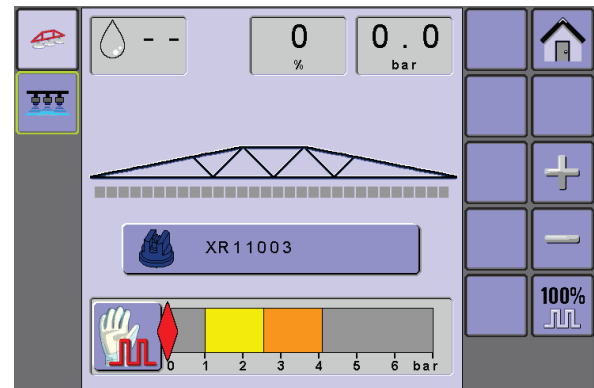

Adjusting PWM Duty Cycle



PWM Increase – Press to increase the PWM Duty Cycle Percentage.



PWM Decrease – Press to decrease the PWM Duty Cycle Percentage.



100% Duty Cycle – Press to jump the PWM duty cycle percentage to 100% (or the preset maximum Duty Cycle).

Droplet Mode

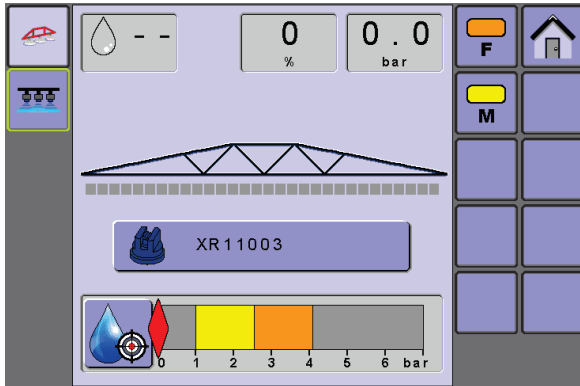

Select the intended nozzle and the target droplet size range. The system will calculate and display the median boom pressure required to meet this droplet size range for the nozzle selected. DynaJet IC7140 will control to maintain the target droplet size range.

Figure 6-5: Operation Screen – Droplet Mode



Droplet Size Engaged/Disabled

Use these softkeys to enable or disable droplet sizes. Droplet selection cannot have skips within the size sequence.

-  Droplet Size Engaged – Indicates the droplet size is included in calculating the target droplet size; Press to disable the droplet size
-  Droplet Size Disabled – indicates the droplet size is not included in calculating the target droplet size; Press to enable the droplet size

Disabled sizes will be crossed out on the pressure gauge.

Figure 6-6: Pressure Gauge – Droplet Size Disabled

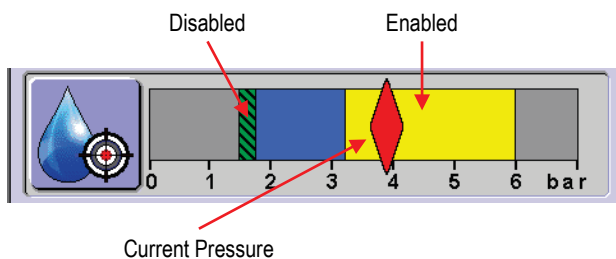

Adjustable Droplet Mode

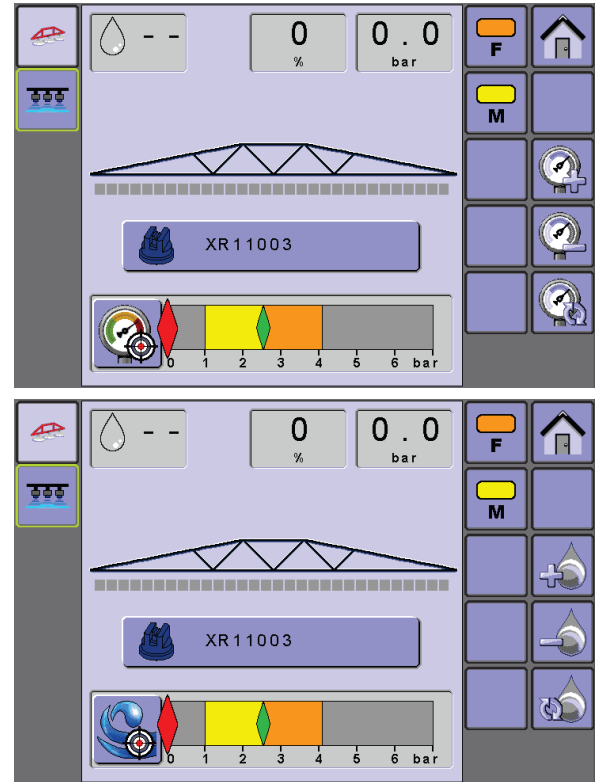

Select the intended nozzle and the droplet size range with the option to adjust the target droplet size. The system will calculate and display the droplet size for the nozzle selected at the target droplet size. DynaJet IC7140 will control to maintain the target droplet size.

Figure 6-7: Operation Screen – Adjustable Droplet Modes



Droplet Size Engaged/Disabled

Use these softkeys to enable or disable droplet sizes. Droplet selection cannot have skips within the size sequence.

-  Droplet Size Engaged – Indicates the droplet size is included in calculating the target droplet size; Press to disable the droplet size
-  Droplet Size Disabled – indicates the droplet size is not included in calculating the target droplet size; Press to enable the droplet size

Disabled sizes will be crossed out on the pressure gauge.

Figure 6-8: Pressure Gauge – Droplet Size Disabled

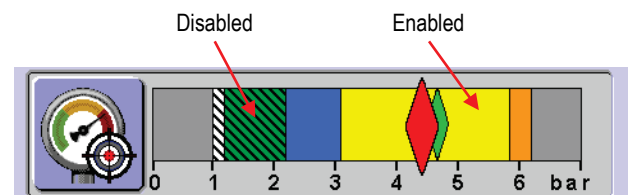

DynaJet® IC7140

Adjusting Target Droplet Size



- 
 Droplet Size Increase – Press to increase the target droplet size (decreases the target pressure on the pressure gauge)
- 
 Droplet Size Decrease – Press to decrease the target droplet size (increases the target pressure on the pressure gauge)
- 
 Droplet Size Reset – Press to clear the increase/decrease to the target droplet size

Figure 6-9: Pressure Gauge – Pressure Indicators



BOOM APPLICATION ACTIVITY

Boom application activity is indicated below the static boom graphic.

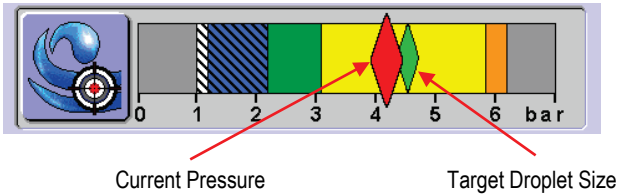
- ◀ Nozzle Status On – Blue
- ◀ Nozzle Status Off – Gray

Figure 6-10: Boom Application Activity – Less than 43 Nozzles

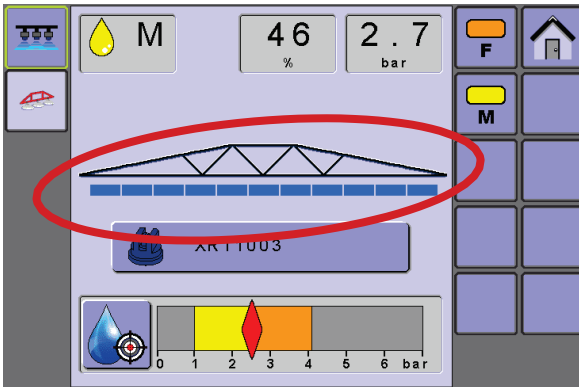

More than 43 Nozzles

When more than 43 nozzles are programmed, application status will no longer include spacing between individual nozzles.

Figure 6-11: Boom Application Activity - More than 43 Nozzles

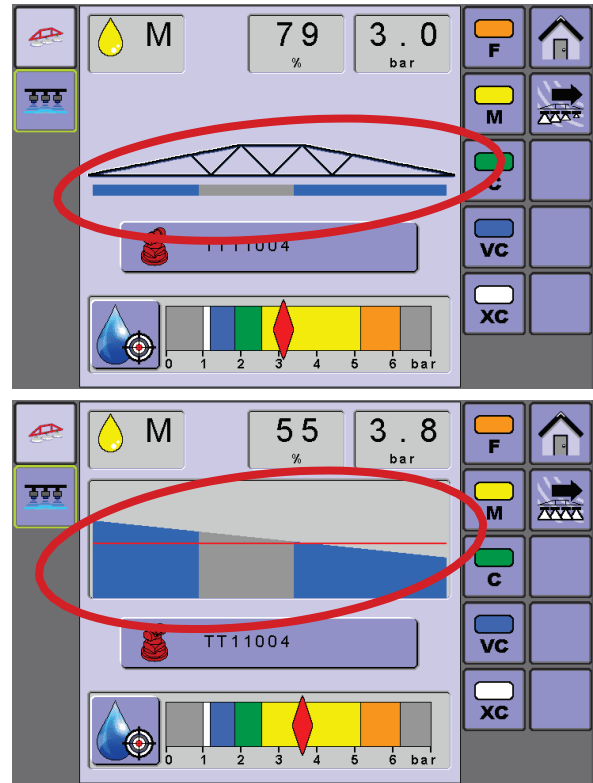

Turn Compensation Enabled

When turn compensation is on, the turn compensation graph replaces the static boom graphic.

See the Turn Compensation section of this chapter for more details.

Figure 6-12: Turn Compensation Enabled

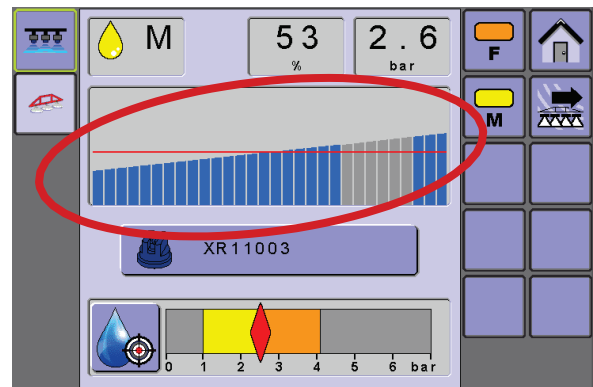

CONTROL ERRORS & ALERTS

If there is an active control error, the value background will be red to indicate the error. The specific error will be specified on the pop-up alert screen.

Control alerts will clear themselves when the control has returned to operational range

Errors with control levels are displayed graphically on the Active Information bar to help the operator stay alert of any problems.

NOTE: System Component errors appear on the System Overview screen. See the SYSTEM OVERVIEW chapter for details.

- Current Droplet Size – Droplet size is not being maintained by the system or Nozzle pressure is above/below the recommended nozzle pressure range
- PWM Duty Cycle – Desired pressure is not being maintained by the system
- Current Boom Pressure – System pressure is above the high pressure alarm value

Figure 6-13: Control Error Example

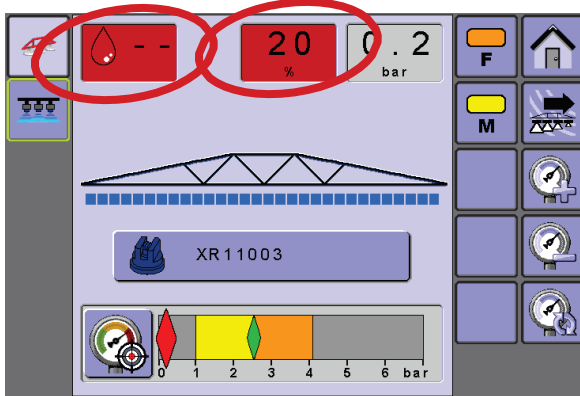

Pop-up Alert Screens

If there is an active error, an alert screen will appear providing specific information and associated error code.

See " Appendix B – TROUBLESHOOTING GUIDE -> Alert Overview" for details on specific errors.

Figure 6-14: System Alert Example

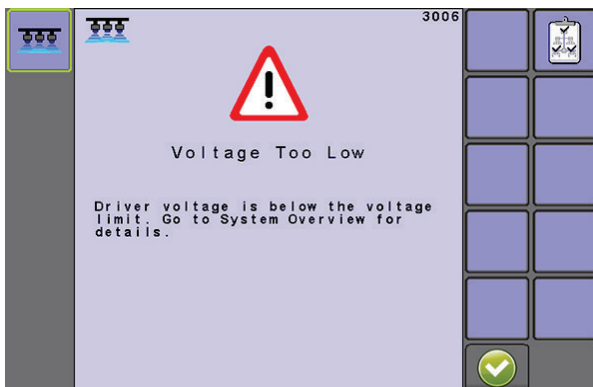

NON-TOUCHSCREEN UT OPTIONS

When using a UT that does not have a touchscreen, screen options will be available as additional softkeys not illustrated in the examples in this manual. Use these softkeys to navigate through the options:

Operation Modes

- To Adjustable Droplet Mode – Press to change operation mode to adjustable droplet mode
- To Droplet Mode – Press to change operation mode to droplet (automatic) mode
- To Manual Mode – Press to change operation mode to manual (PWM) mode

Nozzle Favourites

- Nozzle Favourites – Press to go to the Nozzle Favourites screen

Figure 6-15: Non-Touchscreen UT Options

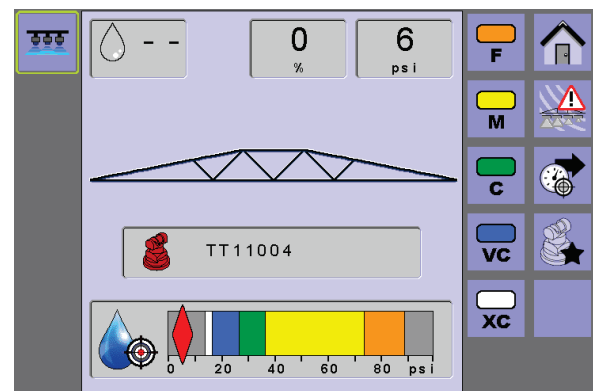

TURN COMPENSATION

As the vehicle turns, the PWM value of each nozzle is displayed on the screen as a graph to show how the system adjusts the PWM to compensate for the turn rate of the vehicle.

NOTICE: Standard Turn Compensation or Advanced Turn Compensation must be unlocked to be available on the Operation screen.

- ▶ Turn Compensation On – As the vehicle turns, the PWM value of each nozzle is displayed on the screen as a graph to show how the system adjusts the PWM to compensate for the turn rate of the vehicle
 - ▶ Nozzle Status On – blue
 - ▶ Nozzle Status Off – grey
 - ▶ Target PWM Duty Cycle – red horizontal line
- ▶ Turn Compensation Off – the turn compensation graph is replaced with a static boom graphic. Boom application activity is indicated below the boom graphic.

Use these softkeys to activate or deactivate turn compensation:



Turn Compensation On – Press to toggle turn compensation on.



Turn Compensation Off – Press to toggle turn compensation off.



Turn Compensation Error – Shown when turn compensation has been disengaged and will remain unavailable until the error is corrected. Communication with the speed source has been lost. Speed is required for turn compensation. Verify speed source availability.

Figure 6-16: Turn Compensation On – Right Turn

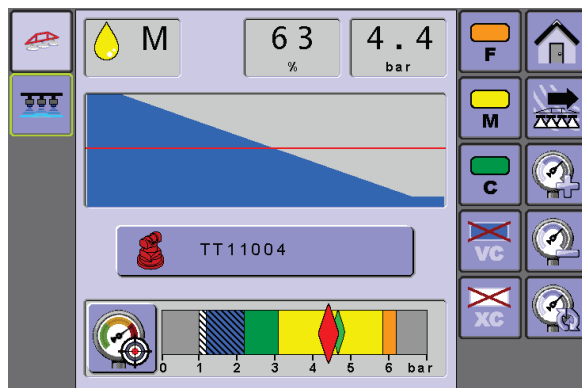

Figure 6-17: Turn Compensation On – Straight

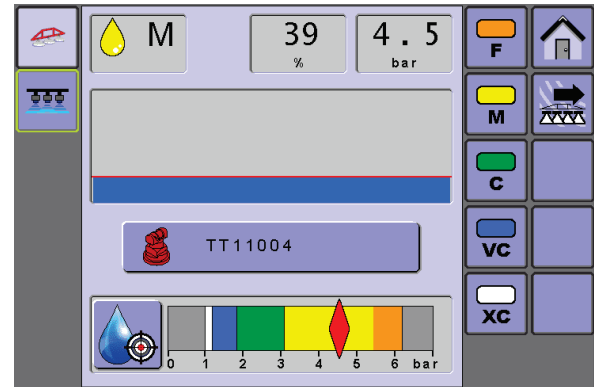
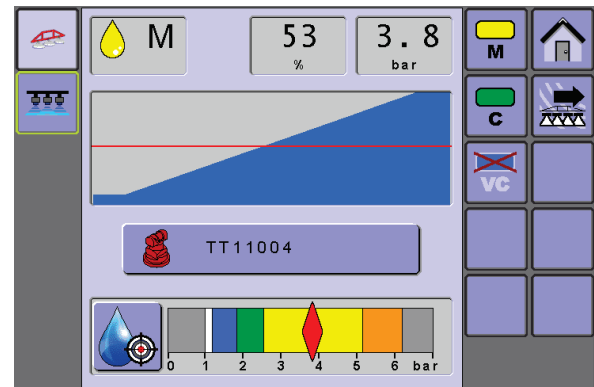

Figure 6-18: Turn Compensation On – Left Turn



Good Practices Guide

DynaJet IC7140's capability to compensate rates across the boom while in a turn is influenced by nozzle selection, speed, target rate and rate of turn.

Optimum PWM

When utilizing turn compensation at optimum PWM, it is represented with an even diagonal line on the Turn Compensation graph. Optimum PWM is attained with an acceptable speed and PWM allowing all e-ChemSaver Solenoids to compensate for turn rate without going to Maximum PWM or Minimum PWM.

Figure 6-19: Optimum PWM

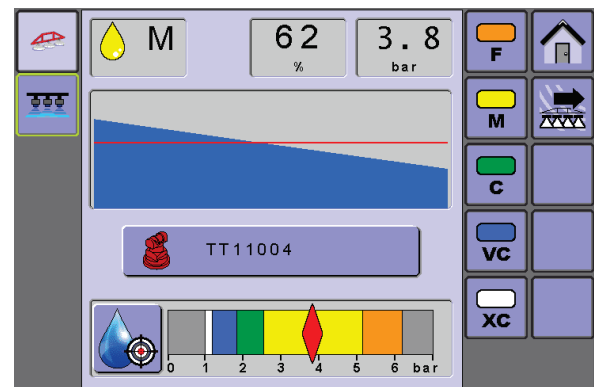

Minimum PWM

As minimum PWM is attained, it is represented with a flat spot on the Turn Compensation graph. Indicating implement speed is too slow, and several e-ChemSaver Solenoids are operating at the minimum PWM, not allowing compensation for the turn rate.

Figure 6-20: Minimum PWM

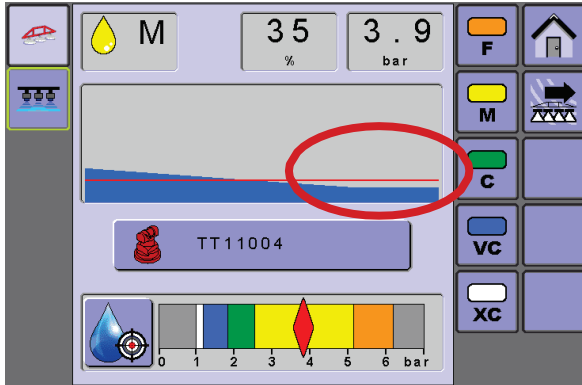

Minimum PWM Solution

If conditions allow, increase speed, or disable a smaller droplet size to force a higher PWM.

Figure 6-21: Minimum PWM Solution

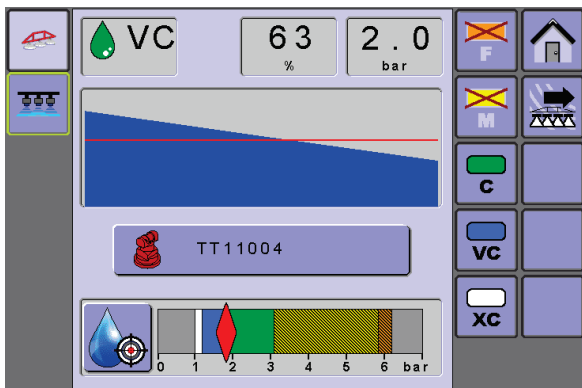

Maximum PWM

As maximum PWM is attained, it is represented with a flat spot on the Turn Compensation graph. Indicating implement speed is too high, and several e-ChemSaver Solenoids are operating at the maximum PWM, not allowing compensation for the turn rate.

Figure 6-22: Maximum PWM

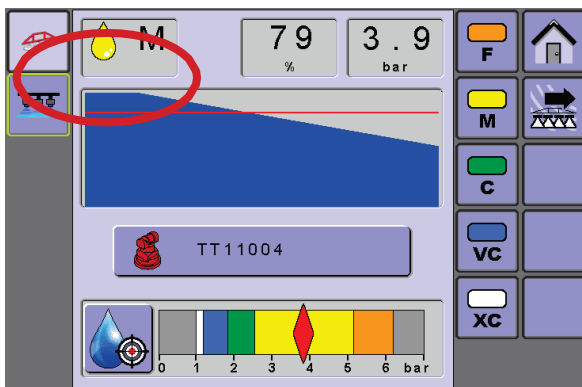

Maximum PWM Solution

If conditions allow, decrease speed, or disable a larger droplet size to force a lower PWM.

Figure 6-23: Maximum PWM Solution

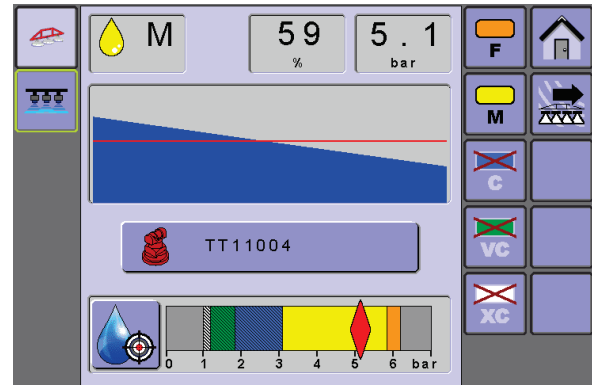

- 1
- 2
- 3
- 4
- 5
- 6
- 7
- 8
- 9
- A

CHAPTER 7 - SYSTEM OVERVIEW

Displays system graphically to help the operator locate any problems as well as give information on selected drivers or solenoids.

NOTE: Information on the System Overview screen will vary depending on the parameters set by the user and the OEM.

Figure 7-1: System Overview Screen Without Errors

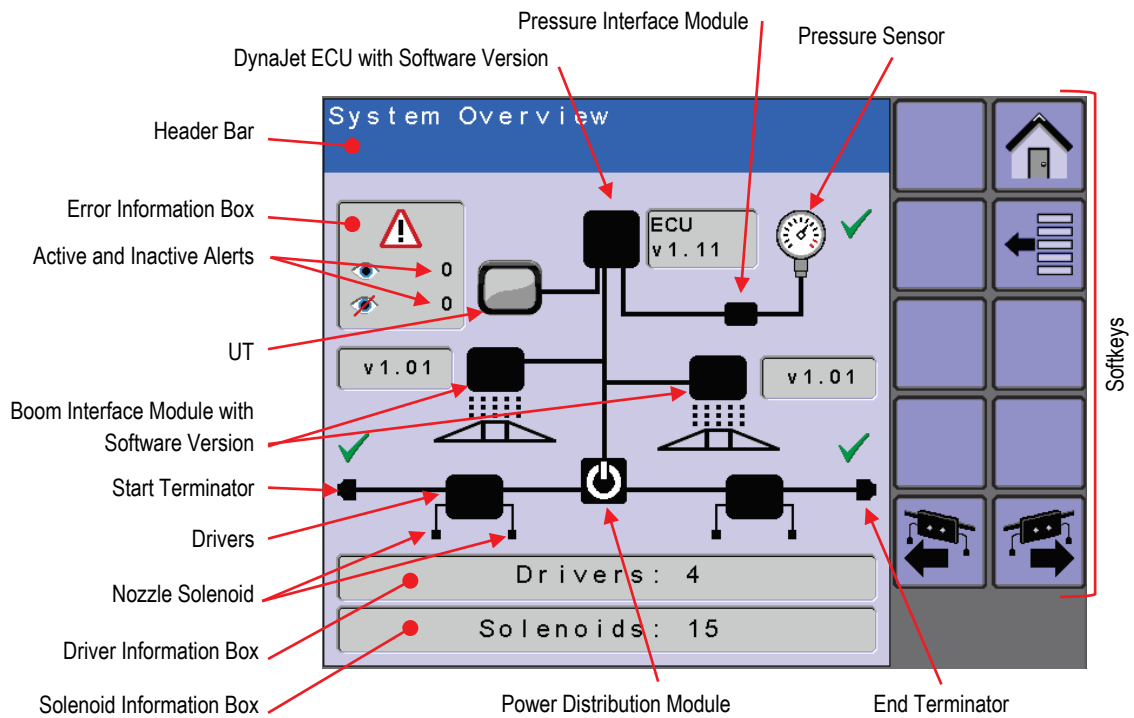

Use these softkeys to assist in establishing settings:



Home – Press to go to the Home screen.



Back One Screen – Press to return to the Help menu screen or Home screen.



Previous/Next Driver – Press to access the driver information on the previous or next screen



Reset Error Log – Press to clear all error log counts to zero, including ignored errors, then checks for new errors

NOTE: When there are no errors, softkey is not available.



Error Information – Press to access details about errors

NOTE: When there are no errors, softkey is not available.

Accessing the System Overview Screen

The System Overview screen can be accessed from multiple locations including directly from the Home screen, through the Main Setup-> Help options or from an error message.

1. From the Home screen press the MAIN SETUP SCREEN KEY.
2. Select **Help**.
3. Select **System Overview**.

Figure 7-2: System Overview – Through Main Setup

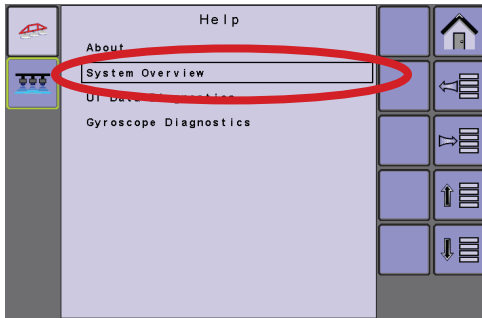

1. From the Home Screen, press SYSTEM OVERVIEW KEY.

Figure 7-3: System Overview – Through the Home Screen

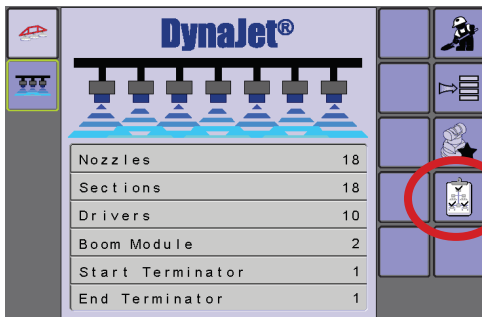

1. From an error message, press SYSTEM OVERVIEW KEY.

Figure 7-4: System Overview – Through an Error Message

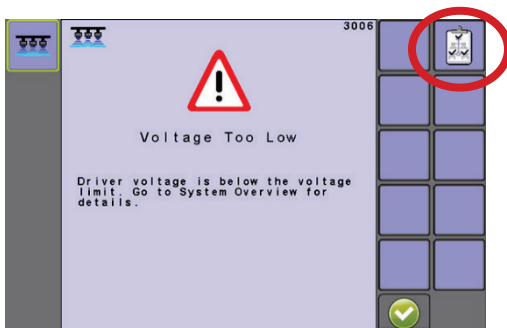

DRIVER/SOLENOID INFORMATION

Specific information about each driver and its associated solenoids can be accessed using the Previous Driver, Next Driver and Next Solenoid softkeys.

Drivers and solenoids are numbered from left to right while facing in the machine's forward direction.

Figure 7-5: Drivers and Solenoids

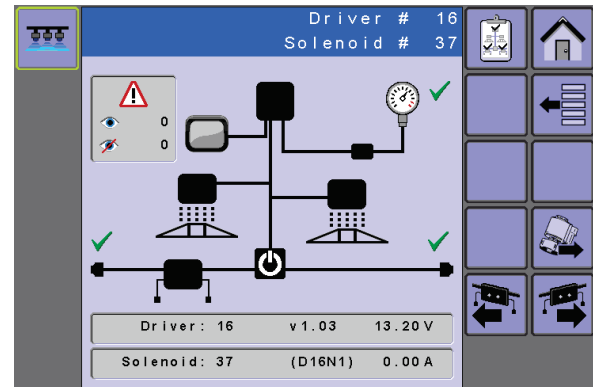

Use these softkeys to navigate through the information screens:

- Next Driver – Press to go the driver on the next screen
- Previous Driver – Press to go the driver on the previous screen
- Next Solenoid – Press to view the next solenoid on the selected driver
- Return to System Overview – Press to go to the system overview screen

Driver Information

The information box displays the driver number, its software version and voltage at the driver.

Figure 7-6: Driver Information

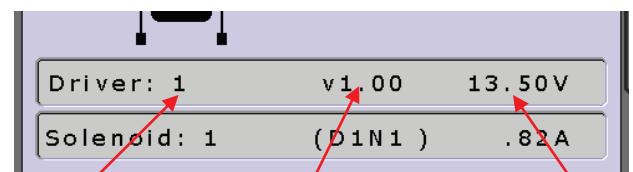

Number Version Voltage

To access the other drivers:

1. Press PREVIOUS DRIVER / NEXT DRIVER KEYS.

Figure 7-7: Previous / Next Driver

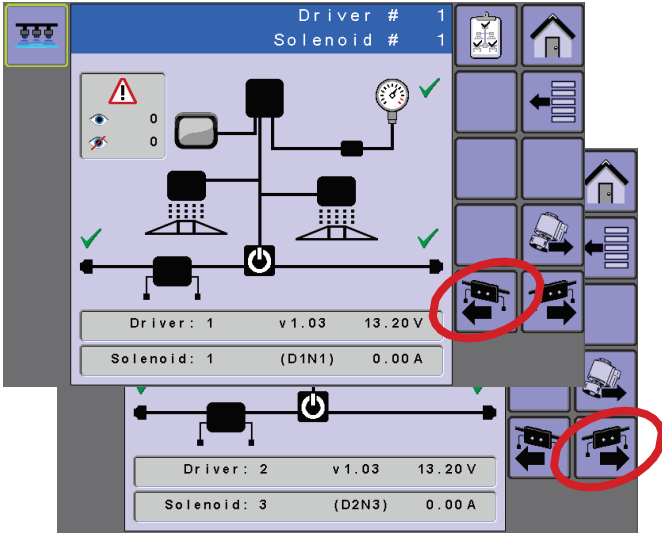

Solenoid Information

The information box displays the selected solenoid number, location and current through the coil. Solenoid location is notated with the driver number (D) and output number (N).

Figure 7-8: Solenoid Information

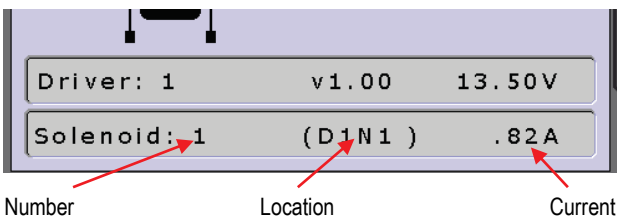

To access another solenoid on the selected driver:

1. Press NEXT SOLENOID KEY.

Figure 7-9: Next Solenoid

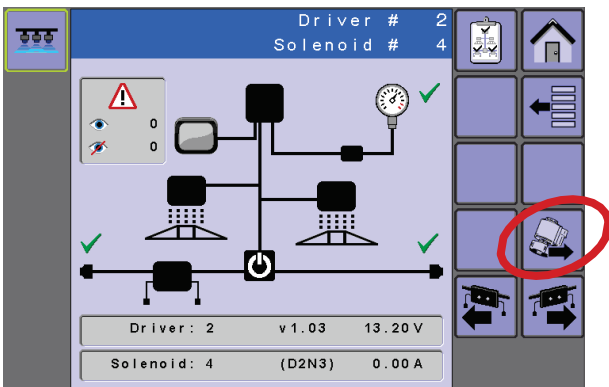

SYSTEM ERRORS

Errors with components of the system are displayed graphically on the System Overview screens to help the operator locate any problems.

NOTE: Operation errors appear on the Operation screen. See the Operation chapter for details.

Pop-up Alert Screens

If there is an active error, an alert screen will appear providing specific information, associated error code and a softkey to go directly to the System Overview screen.

See "Appendix C – TROUBLESHOOTING GUIDE" for details on specific errors.

Figure 7-10: System Alert Example

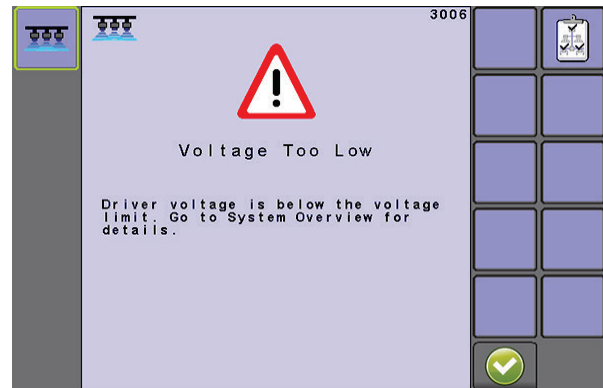

Use these softkeys to navigate from the pop-up screen:



System Overview – Press to go to the System Overview screens for troubleshooting issues



Accept – Press to acknowledge a system alert and return to the previous screen

System Overview – Press to go to the System Overview screens for troubleshooting issues

Accept – Press to acknowledge a system alert and return to the previous screen

NOTE: Ignored and/or accepted driver and solenoid errors will be acknowledged on their associated information screens.

System Overview Screen

The system overview screen will indicate the offending system component in red with an error icon. The specific error will be specified on the screen header.

The Error Information Box displays the number of current errors and number of ignored errors.

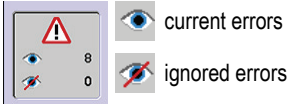
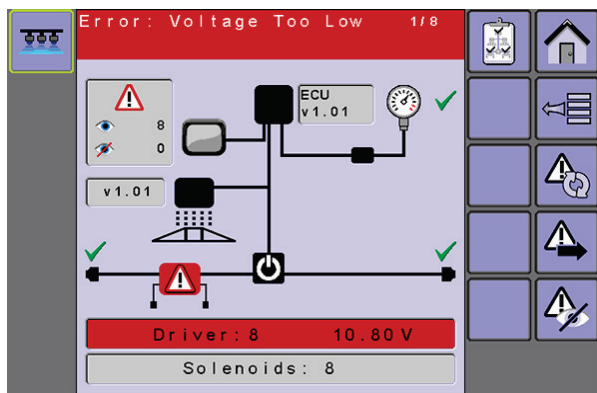

Figure 7-11: System Overview Error Example



Use these softkeys to navigate through the errors:

- Refresh Error Log – Press to clear the error log counts to zero, including ignored errors, then checks for new errors
- Next Error – Press to view the next error when multiple errors occur
- Next Error Greyed – only one error available
- Ignore Error – Press to disregard an error (not all errors can be ignored)

NOTE: All ignored errors will be reset/cleared when the system is repowered.

Home Screen Visibility

The Home screen gives the user a quick overview of the status of the system. Initialisation errors and system errors appear to alert the operator of certain issues and can prevent the console from entering operation mode until rectified.

Figure 7-12: Initialisation Error Example

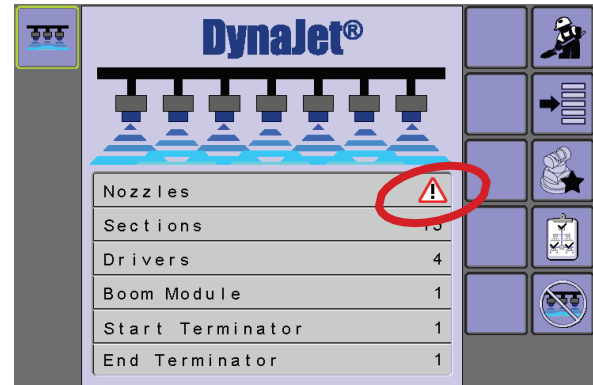

APPENDIX A – DYNAJET APPLICATION CHARTS

DYNAJET IC7140 NOZZLE SELECTION

Selection of the proper spray nozzle for use with the DynaJet IC7140 system is much like selecting the spray nozzle for a traditional spraying operation. Along with the extra application flexibility, DynaJet IC7140 brings a few other nozzle-related considerations that will be summarised below.

1. Duty Cycle

- a. DynaJet IC7140 controls nozzle flow rate by varying the portion of time that each nozzle is 'on' vs. 'off'. The on time is referred to as duty cycle. The range of duty cycle available is typically 30% to 100%, meaning that the nozzles on the machine will have the approximately 30% to 100% of their rated flow capacity.
- b. With the DynaJet IC7140 system: **spray nozzle flow capacity = spray nozzle size x duty cycle**
- c. By varying the duty cycle, the DynaJet IC7140 is essentially varying spray nozzle capacity on the fly. When more pressure is required, the nozzle capacity (duty cycle) is reduced. When higher nozzle capacity is required, the duty cycle is increased.
- d. Although the operator has a much more flexible and forgiving application system with DynaJet IC7140, care should be taken to select spray nozzles that give the best possible results.
- e. When selecting a spray nozzle, review the DynaJet IC7140 nozzle selection charts and select a spray nozzle capacity that produces the target application rate at a duty cycle of about 70% when running at expected travel speeds. In other words, choose nozzle capacity and desired pressure/droplet size closer to the high end of the speed (or rate) range than to the lower end. This will provide plenty of adjustment range for DynaJet IC7140 to reduce duty cycle when travel speed slows, while also providing additional capacity if travel speed increases above the planned speed.
 - The default setting for minimum duty cycle is 30%. This means the system will not adjust the duty cycle below 30% 'on'. While this setting can be set as low as 20% by the operator, the higher default value provides a more uniform application at lower speeds.

2. Spray Nozzle Selection

- a. The DynaJet IC7140 system is not compatible with all spray nozzles. Approved nozzle series include: AI Turbo TwinJet, Turbo TeeJet Induction TwinJet, Turbo TeeJet, Turbo TeeJet Induction, Turbo TwinJet, TwinJet 110, TX ConeJet, TXA ConeJet, TXR ConeJet, XR TeeJet 110 and XRC TeeJet 110.

NOTE: Listed series may not include all available capacities. Changes to series and/or capacities may occur with software updates.
- b. Different nozzle styles have different droplet size characteristics across the range of operating pressures. The spray nozzle style should be selected based on the desired droplet size at the pressures expected to be in use for your application.
- c. Always use spray nozzles with 110° (or wider) spray pattern. These spray nozzle part numbers will typically include the 110 in their name – for example TT11006VP or XR11006-VS. 80° spray nozzles are not recommended with DynaJet IC7140.

3. Spray Height

- a. In order to achieve the best possible spray coverage, make sure to keep spray height at or above 50 centimeters / 20 inches from the nozzle to the target.

UNAVAILABLE MODES

Operation Mode

Due to a system error, the Operation Mode is not available. Errors causing this unavailability include:

- 3002 Missing Start Terminator
- 3003 Missing End Terminator
- 3004 Missing Solenoid
- 3009 Missing Pressure Sensor
- 3010 Missing Boom Interface Module
- 3011 Missing IOM Pressure Sensor
- 3012 Missing Driver(s)
- 3022 Boom Setup Error
- 3028 Initialisation Error
- 3029 Operation Error: All Solenoids Open
- 3030 Operation Error: All Solenoids Closed
- 3033 Missing Rate Controller: All Solenoids Open
- 3034 Missing Rate Controller: All Solenoids Closed

For details on each of these alerts, see the Alert Overview section of this chapter.

Figure 7-13: Operation Mode Unavailable

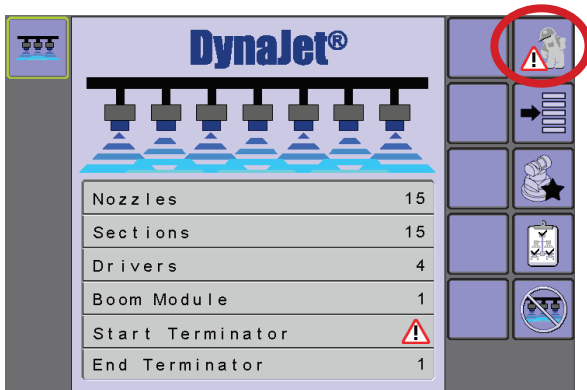

Disengage Mode

Disengage Mode is not available due to an active application state such as Master Switch On or one or more sections on.

Disengage active application to enter Disengage Mode.

Figure 7-14: Disengage Mode Unavailable

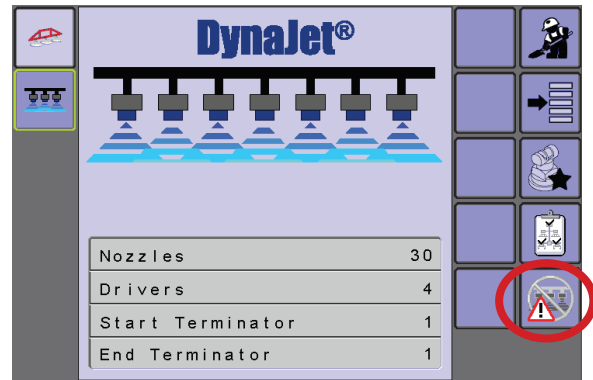

Turn Compensation

Turn Compensation On/Off Unavailable

Turn Compensation has been disengaged. Communication with the speed source has been lost. Speed is required for turn compensation. Verify speed source availability.

Figure 7-15: Turn Compensation On/Off Key Unavailable

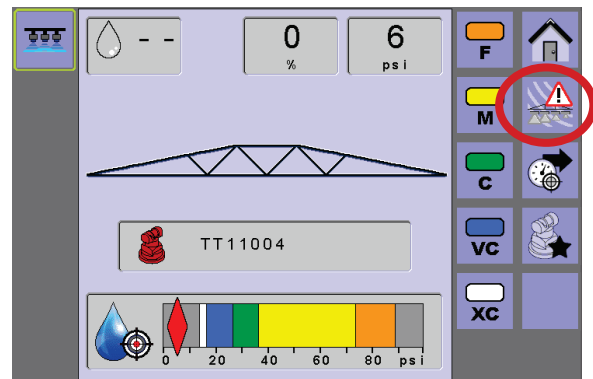

Turn Compensation Visual Unavailable

Although turn compensation is active, the visual on the Operation screen is not shown. The Turn Compensation Visual can be enabled/disabled from the User Interface settings. Verify the Turn Compensation Visual is enabled.

Figure 7-16: Turn Compensation Visual Unavailable

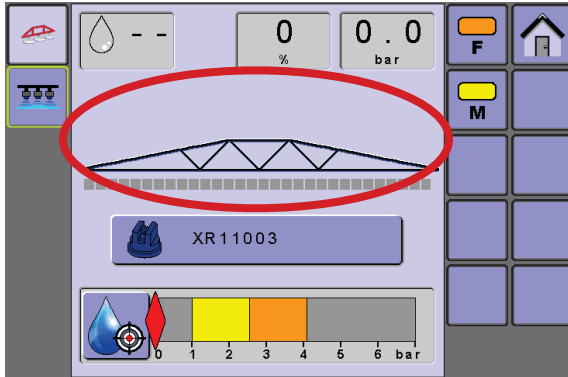

Turn Compensation Unavailable

Turn Compensation is not available on the Operation screen. Turn Compensation is locked. Contact an authorized TeeJet Technologies local dealer for unlock code availability. See bulletin 98-01563 Standard Turn Compensation Unlock or bulletin 98-01564 Advanced Turn Compensation Unlock for unlock instructions.

Figure 7-17: Turn Compensation Unavailable

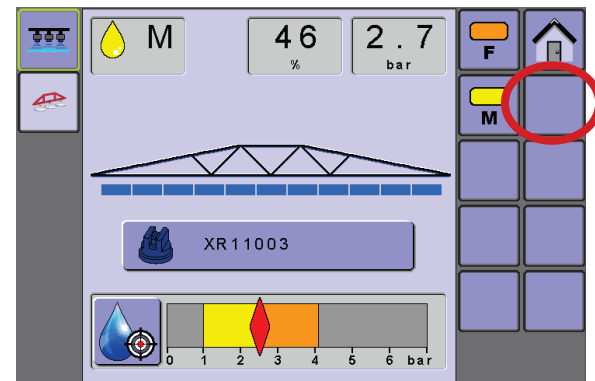

ALERT OVERVIEW

Alert Code	Error	Description	Action
1002	Screen Resolution Alert	Display graphics are best seen on 480x480 screen resolution. Graphic representations may be affected below the recommended screen resolution.	Press the Accept key
1003	Softkey Size Alert	Due to size conformities, softkeys will use basic graphics.	Press the Accept key
1004	End User Licence Agreement	ALWAYS READ AND FOLLOW THE CHEMICAL LABEL'S DIRECTIONS. Droplet size classification is in accordance with ISO 25358 at the date of publication. Classifications are subject to change. The chemical being sprayed, tank mixes, temperature, humidity, wind speed, vehicle speed, etc. can influence the actual drop size.	Press the Accept key Occurs on console power-up. Operator must press the Accept key to use the system
3002	Missing Start Terminator	Start terminator is not detected. Terminator is required for Operation Mode.	
3003	Missing End Terminator	End terminator is not detected. Terminator is required for Operation Mode.	
3004	Missing Solenoid	One or more solenoids are not detected. Detecting all solenoids or ignoring one specific alert is required for Operation Mode.	Go to SYSTEM OVERVIEW for details
3005	Voltage Too High	Driver voltage is above the high voltage limit.	Go to SYSTEM OVERVIEW for details
3006	Voltage Too Low	Driver voltage is below the low voltage limit.	Go to SYSTEM OVERVIEW for details
3007	Solenoid Current Too High	Solenoid current is above the high current limit.	Go to SYSTEM OVERVIEW for details

Alert Code	Error	Description	Action
3008	Solenoid Current Too Low	Solenoid current is below the low current limit.	Go to SYSTEM OVERVIEW for details
3009	Missing Pressure Sensor	Pressure sensor is not detected. Pressure sensor is required for Operation Mode.	
3010	Missing Boom Interface Module	Communication to the Boom Interface Module has been lost. Boom Interface Module is required for Operation Mode.	
3011	Missing IOM Pressure Sensor	Communication to the Input Output Module (IOM) Pressure Sensor has been lost. IOM Pressure Sensor is required for Operation Mode	
3012	Missing Driver(s)	Communication to a driver or drivers has been lost. All drivers are required for Operation Mode.	Go to SYSTEM OVERVIEW for details
3015	Minimum Duty Cycle Reached	Desired pressure is not being maintained by the system. The control duty cycle has fallen to the minimum threshold.	
3016	Above Maximum Duty Cycle	Desired pressure is not being maintained by the system. The control duty cycle has risen above the maximum threshold.	
3017	Above High Pressure	System pressure is above the high pressure alarm value. The duty cycle has reached the maximum and pressure is still too high.	
3018	Outside Droplet Size	Droplet size is not being maintained by the system.	
3019	Above High Pressure	System pressure is above the high pressure alarm value.	
3020	Below Low Pressure	Nozzle pressure is below the recommended nozzle pressure range.	
3021	Above High Pressure	Nozzle pressure is above the recommended nozzle pressure range.	
3022	Boom Setup Error	Number of implement nozzles and flow regulator nozzles are mismatched.	Go to Main Menu-> Machine Setup for details.
3028	At Initialisation, the following errors may have occurred: <ul style="list-style-type: none"> • 3002 Missing Start Terminator • 3003 Missing End Terminator • 3009 Missing Pressure Sensor • 3022 Boom Setup Error 	At least one or more initialisation errors has occurred. <i>NOTE: This alert replaces the above pop-ups ONLY at Initialisation.</i>	Review alerts on the Home screen and/or System Overview for details on the error(s). Once all errors have been addressed, restart the system. When an 8-output driver is installed, see Initialisation Boom Setup Error with 8-output Drivers for more details.
3029	Operation Error: All Solenoids Open	An issue on the system has occurred preventing access to the Operation screen. To avoid additional issues, all Solenoids have been opened.	Please stop application and address the operation issue.

Alert Code	Error	Description	Action
3030	Operation Error: All Solenoids Closed	An issue on the system has occurred preventing access to the Operation screen. To avoid additional issues, all Solenoids have been closed.	Please stop application and address the operation issue
3031	Solenoid Not Working Properly <i>Note: This alert is only available on select configurations.</i>	At least one or more solenoids are not opening or closing completely.	Go to SYSTEM OVERVIEW for details on the error(s).
3032	Turn Compensation Disengaged	Communication with the speed source has been lost. Speed is required for turn compensation. Turn compensation has been disengaged.	Verify speed source availability. Use the Turn Compensation On key on the Operation Screen to turn compensation on.
3033	Missing Rate Controller: All Solenoids Open	Communication with the Rate Controller has been lost. To avoid additional issues, all Solenoids have been opened.	Verify Rate Controller is available then restart the system.
3034	Missing Rate Controller: All Solenoids Closed	Communication with the Rate Controller has been lost. To avoid additional issues, all Solenoids have been closed.	Verify Rate Controller is available then restart the system.
3100	Standard Turn Compensation Unlock Successful!	The Standard Turn Compensation feature is now unlocked.	Restart the system to begin using Standard Turn Compensation.
3101	Standard Turn Compensation Unlock Failed!	The Standard Turn Compensation feature remains locked.	Verify unlock code. Reenter unlock code.
3102	Advanced Turn Compensation Unlock Successful!	The Advanced Turn Compensation feature is now unlocked.	Restart the system to begin using Advanced Turn Compensation.
3103	Advanced Turn Compensation Unlock Failed!	The Advanced Turn Compensation feature remains locked.	Verify unlock code. Reenter unlock code.
3104	Individual Nozzle Shutoff Unlock Successful!	The Individual Nozzle Shutoff feature is now unlocked.	Restart the system to begin using Individual Nozzle Shutoff.
3105	Individual Nozzle Shutoff Unlock Failed!	The Individual Nozzle Shutoff feature remains locked.	Verify unlock code. Reenter unlock code.
3106	Variable Rate (VRA) Unlock Successful!	The Variable Rate (VRA) feature is now unlocked.	Restart the system to begin using Variable Rate (VRA).
3107	Variable Rate (VRA) Unlock Failed!	The Variable Rate (VRA) feature remains locked.	Verify unlock code. Reenter unlock code.

INITIALISATION BOOM SETUP ERROR WITH 8-OUTPUT DRIVERS

When an 8-output driver system on start-up/initialisation has a missing solenoid in the 8th position of a driver, the number of sections on the DynaJet will not match the associated rate controller causing the 3028 Initialisation error due to the 3022 Boom Setup Error.

This happens when using an 8-output driver and the solenoid in error happens to be sitting in the 8th position. This is part of intended programming in the drivers where the system checks for the end of the driver by looking solenoid ahead. If the 8th solenoid is missing, then the system thinks there are only 7 solenoids on that driver.

Figure 7-18: Drivers and Solenoids Without Error

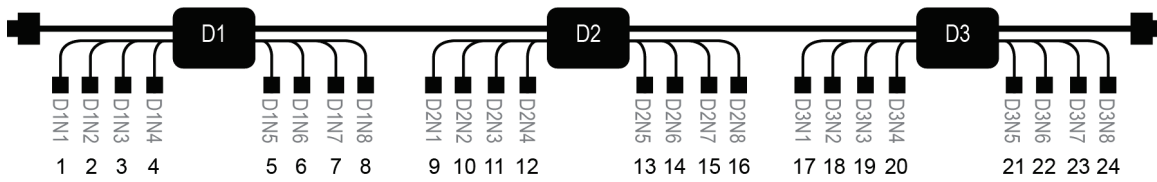
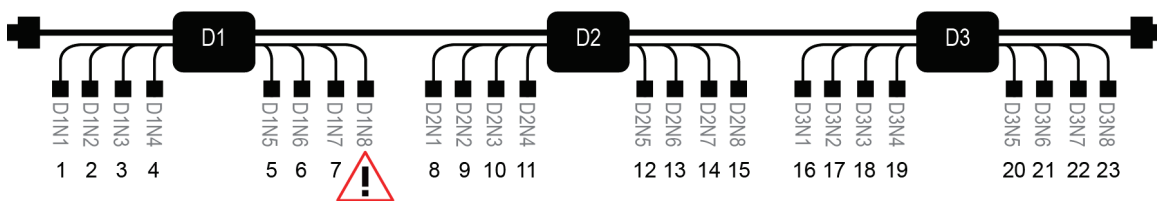

Figure 7-19: Drivers and Solenoids With Error in Position 8



115880 E-CHEMSAVER®

MAINTENANCE INSTRUCTIONS

The 115880 e-ChemSaver is a solenoid-actuated shutoff compatible with a wide range of TeeJet nozzle bodies equipped with a diaphragm check valve. It can be used for end-of-boom nozzles as well as individual nozzle shutoff and PWM controls. e-ChemSaver is the commercial given name for an electrical device (a coil that creates pulses) connected on each nozzle body.

The valve is normally closed and opens when the solenoid is energized. The 115880 has a 2-Pin SuperSeal 1.5 connector molded into the body for a clean, weather-tight electrical connection. This technical component works under a very high frequency; 20Hz (meaning 20 open/close cycles per second). Within this frequency level, is crucial to maintain the e-ChemSaver properly.

e-ChemSavers Precautions

A few general maintenance steps will assist in maintaining a properly working system. See your sprayer manufacturer's recommended maintenance and inspection procedures for additional information.

Water's Quality

Is very important to use solid particle's free water (such as sand, metal chips, calcium...). Pay special attention when filling from a natural source, or a different one from a domestic. To filter while filling the tank is highly recommended in spite of the origin, with at least a 80mesh strainer.

Plant Protection Products

Any product silicon-based is **FORMALLY MISADVISED**, as it is harmful for the e-ChemSavers. In a general way, pay attention to any PPP containing solid particles.

Filtration

Any special survey to the filtration conditions is highly recommended during the applications Use at least 80mesh strainers.

Cables

Prior to operating, check all connections, including all solenoid connections, for corrosion, water, damaged pins, etc. See the External Inspection section for examples of proper gasket sealing.

Prevent potential moisture contamination issues by using anti-corrosion products or small form of silicone at each connection, especially the solenoid connections.

Strainers

Remove and clean all the product strainers. Replace the strainers after they are clean and dry.

System Flush

1. Fill the product tank with at least 200 gallons / 750 liters of clean water.
2. If the boom tubes have a flush valve at the end, open the flush valves and flush the boom tubes with 100 gallons / 375 liters of clean water.
3. Remove or open the spray nozzles and flush the booms with the remaining water.

While in use

Rinse system with clean water after each application. 80 mesh strainer screen or finer is recommended with all e-ChemSaver applications. The product screen on the discharge side of the pump should match manufacturer recommendation.

When Using Fertilizer or Chalky Substances

Fertilizer has a tendency to plug screens faster that water if left out to settle.

- Ensure the machine is cleaned out daily and does not sit with product in the application system overnight.
- Verify that without solenoids operating the system does not exhibit any flow issues.
- Ensure 80 mesh screens are clean and free of debris.

Storage

When not actively using the system, a few general maintenance steps will assist in maintaining a properly working system for the next season. See your sprayer manufacturer's recommended storage procedures for additional information.

1. Empty product from the chemical supply tank.
2. Flush the application system with water.
3. Flush the application system with tank cleaner.
 - Purchase a tank cleaner. Follow the manufacturer's directions for water quantity and dilution rate.
 - Rinse the tank according the tank cleaner directions. Do not let the tank cleaner sit in the spray boom or e-ChemSavers. Tank cleaner must be completely flushed out of the system.
4. After rinsing with the tank cleaner, flush the spray boom and nozzles with 50 - 100 gallons / 200 - 375 liters of clean water.
 - If applying a water-based product, flush the system with soap and water.
5. If Winterizing – Prime the system plumbing with a water and automotive antifreeze mixture appropriate for the local environment to prevent freezing of valve components.





E-CHEMSAVER MAINTENANCE

With proper equipment maintenance (as recommended by the equipment or chemical manufacturer), TeeJet solenoids are designed to provide up to 500 hours maintenance free operation. The following solenoid maintenance procedures should be performed on the solenoid or on individual nozzles if leaks are observed at a specific spray nozzle.

Regular inspection of the e-ChemSaver is required for optimal functionality and proper operation under any circumstances.

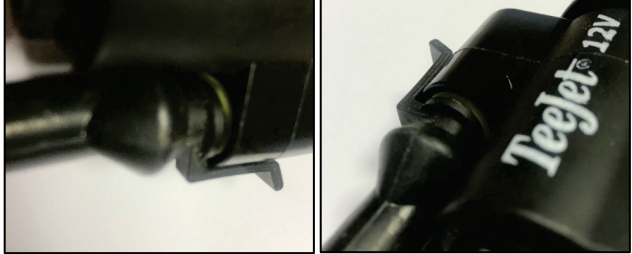

External Inspection

The following parts should be visually inspected before each use.

Inspection Area	Procedure	Example
<p>Gasket Seal</p>	<p>The correct gasket seal ensures a proper connection of the cable.</p> <p>In case of difficulty when connecting the cable, apply special grease to ensure a proper connection.</p>	<p>Gasket OK</p>  <p>Gasket Not OK</p> 
<p>Tighten Tension between the e-ChemSaver and the nozzle body</p>	<p>Install by hand, tightening until a complete block.</p>	
<p>Rear Nut's Tighten Tension</p>	<p>Install by hand, tightening until a complete block. Afterwards ensure it with an additional 1/4 of turn with an appropriate tool.</p>	

Internal Inspection

After any inspection, reassemble all the parts as shown in the Solenoid Disassembly and Reassembly instructions referred in this bulletin.

Inspection Area	Procedure	Example
Coil Assembly (2)	If any external body was present in the stainless-steel tube, clean using dry, forced air.	<div style="display: flex; justify-content: space-around;"> <div style="text-align: center;"> <p>Clean and Proper</p>  </div> <div style="text-align: center;"> <p>Dirty</p>  </div> </div>
O-Ring (9)	Observe that the O-ring is well well-maintained. In case of degradation, replace it.	<p>Proper O-Ring</p> 
O-Ring (8)	Observe that the O-ring is well well-maintained. In case of degradation, replace it.	
Interface Cap (7)	Clean using clear water. Do not use any tool. In case of need, a paintbrush can be use as well as pressurized air.	<p>Blocked or Plugged Holes</p> 
Tube Sub-Assembly (3) Internal	If any solid is present, clean with water.	<div style="display: flex; justify-content: space-around;"> <div style="text-align: center;"> <p>Dirty</p>  </div> <div style="text-align: center;"> <p>Clean</p>  </div> </div>

Inspection Area	Procedure	Example
<p>Tube Sub-Assembly (3)</p>	<p>Clean and inspect the Tube Sub-Assembly (4). Replace the tube assembly if the rubber seal is worn or damaged.</p>	<p>Before</p>  <p>After</p> 
<p>Brown O-Ring (6)</p>	<p>Observe that the O-ring is well well-maintained. In case of degradation, replace it.</p>	<p>Proper O-Ring</p> 
<p>Stainless Steel Spring (5)</p>	<p>Inspect. Replace if necessary.</p>	
<p>Plunger (4) gasket</p>	<p>If a severe degradation, replace the complete kit (Reference AB115880-2-KIT).</p>	<p>Gasket OK</p>  <p>Gasket Not OK</p> 

SOLENOID DISASSEMBLY AND REASSEMBLY

NOTE: O-rings (6, 8, 9) should be handled with care as they can be damaged/deformed.

Disassembly

1. Loosen and remove the nylon Nut (1).
2. Separate the Coil Assembly (2) from the rest of the Tube/Plunger Assembly (3-10).
3. Remove the Locking Ring (10).
4. Using e-ChemSaver (CP116231-NYB) wrench or pliers to grip the stainless steel Interface Cap (7), loosen the Tube Sub-Assembly (3) using a 14 mm / 9/16" or adjustable wrench.

All repairable parts should be accessible at this point. The Plunger Sub-Assembly (4), stainless steel Spring (5), and O-rings (6, 8, 9) can be replaced without further disassembly.

Reassembly

5. During reassembly, place the Plunger Sub-Assembly (4) and stainless steel Spring (5) in the Tube Sub-Assembly (3).

NOTE: The Plunger Sub-Assembly (4) should be orientated with the black insert facing outward (visible) when placed in the Tube Sub-Assembly (3).

6. While compressing the Spring (5), thread the Tube/Plunger Assembly (3-10) to the stainless steel Interface Cap (7) and tighten using a wrench and pliers.
 - ▶ Optional: Apply 1 drop of Loctite Blue 243 to the threads of the Interface Cap (7) and Tube Sub-Assembly (3).
 - ▶ Torque Specifications: Tighten Interface Cap (7) and Tube Sub-Assembly (3) to 1.36 N-m / 12 in-lbs.
7. Return the Locking Ring (10) to its original position and slide the Tube/Plunger Assembly (3-10) through the Coil Assembly (2).

NOTE: The Coil Assembly (2) should be orientated with the SuperSeal 1.5 connector facing away from the Interface Cap (7).

8. Tighten the nylon Nut (1) to the Tube/Plunger Assembly (3-10).

Verification After Reassembly

9. Lubricate O-ring (9) before re-attaching the e-ChemSaver to the nozzle body.
10. Attach the solenoid on the nozzle body and inspect for leaks when system is on.

RECOMMENDED: At the time of installation, prior to plugging in the connector, spray a sufficient quantity of CorrosionX®, CorrosionX® Heavy Duty, or CorrosionX® Aviation corrosion prevention compound into the connector to wet the terminals.

ITEM	PART NUMBER	DESCRIPTION
1	CP55289-NYB	NUT, NYLON-BLACK
2	CP115881-12	12V COIL ASSEMBLY
2A	CP115881-24	24V COIL ASSEMBLY
3	N/A	TUBE SUB-ASSEMBLY
4	N/A	PLUNGER SUB-ASSEMBLY
5	N/A	SPRING, 302 STAINLESS STEEL
6	N/A	O-RING, VITON®
7	N/A	INTERFACE CAP, 303 STAINLESS (115880-1-12 & 115880-4-12)
7A	N/A	INTERFACE CAP, 303 STAINLESS (115880-2-12)
8	CP7717-2/116-VI	O-RING, VITON® (115880-1-12 & 115880-2-12)
8A	CP58589-VI	GASKET, VITON® (115880-4-12)
9	CP7717-2-007/VI	O-RING, VITON® (115880-1-12 & 115880-4-12)
9A	CP7717-M4.2X1.9-VI	O-RING, VITON® (115880-2-12)
10	CP55288-NYB	LOCKING RING, NYLON-BLACK

SPARE KITS	
AB115880-1-KIT, SPARE PARTS KIT (INCLUDES ITEMS 4, 5, 6, 8, 9)	
AB115880-2-KIT, SPARE PARTS KIT (INCLUDES ITEMS 4, 5, 6, 8, 9A)	
AB115880-4-KIT, SPARE PARTS KIT (INCLUDES ITEMS 4, 5, 6, 8A, 9)	
AB115880-1-FR-KIT, FIELD REPAIR KIT (INCLUDES ITEMS 1, 3, 4, 5, 6, 7, 8, 9)	
AB115880-2-FR-KIT, FIELD REPAIR KIT (INCLUDES ITEMS 1, 3, 4, 5, 6, 7A, 8, 9A)	

VITON® IS A REGISTERED TRADEMARK OF THE CHEMOURS COMPANY.

DESCRIPTION: 115880-1-12, 115880-2-12, 115880-4-12, 115880-1-24, 115880-2-24, 115880-4-24 e-CHEMESAVER® SOLENOID OPERATED ELECTRIC SHUT-OFF VALVE			
REVISION NO.	2		
REFERENCE	02/20/2020	SHEET	1 OF 1
		DWG SIZE	A

©Spraying Systems Co.

e-ChemSaver Models

If, for any reason, the change of the complete e-ChemSaver is mandatory, there exist 3 different models. For choosing the right one, refer to the interface cap (7) indicating the number of different points marked on it.

- **1 MARK** – Reference 115880-1-12.
- **2 MARKS** – Reference 115880-2-12. (above image)
- **4 MARKS** – Reference 115880-4-12.

Figure 1: Model Markings



TROUBLESHOOTING

This is a list with the most common e-ChemSaver's failures.





NOZZLE LEAKING

After setting off the spray, some nozzles are still leaking.

Issue/Problem	Solution	Example
Plunger's gasket damaged	Change the kit plunger-gasket (Reference AB115880-2-KIT).	
Solid particles present in the gasket	Remove any solid particle present. Clean smoothly with pressurized air.	<p data-bbox="799 747 1078 772">Sand Dust Blocking the Closure</p>  <p data-bbox="799 1100 1102 1125">Metal Chip Inserted In The Gasket</p> 
Stuck plunger in the cylinder due to solid/liquid particles	Clean with water.	<div style="display: flex; justify-content: space-around;"> <div data-bbox="799 1455 1002 1787"> <p data-bbox="799 1455 946 1480">Stucked Plunger</p>  </div> <div data-bbox="1086 1455 1276 1787"> <p data-bbox="1086 1455 1203 1480">Free Plunger</p>  </div> </div>

The e-ChemSaver Doesn't Open

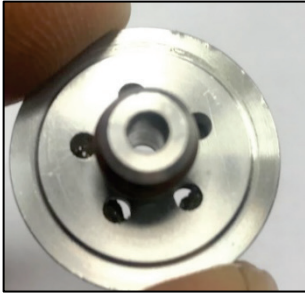
During the spray, some nozzles remain closed not working. Probable causes and solutions.

Issue/Problem	Solution	Example
Blocked, dirty or stuck nozzle	<i>Clean the nozzle with water.</i>	
Damaged electrical connector	<i>Change the coil (Reference CP115881-12).</i>	
Broken or defective coil, pulse is not heard or detected	<i>Change the coil (Reference CP115881-12).</i>	
Stuck e-ChemSaver	<i>Disassemble the e-ChemSaver and clean all the holes with clean water.</i>	
Spray pressure over max working pressure	<i>Lower the working pressure, the e-ChemSaver doesn't admit pressures higher than <u>7 bar / 100 psi</u>.</i>	

Incorrect e-ChemSaver Flow

While controlling the flow nozzle by nozzle, one of them or a section is not spraying the exact amount of volume per time. Probable causes and solutions.

Ensure that the flow is adequate to the nozzle within the legislation setting the system to a 100% duty cycle.

- Set the system up to a 100% duty cycle

If the problem persists (taking account a +/-5%cv) the e-ChemSaver can cause the problem by itself

- The cylinder holes are blocked. Proceed as explained previously.
- The plunger's gasket is broken or damaged. Replace the kit as explained previously.
- Electrical current is not enough. Usually system's voltage should be between 11 and 14V. Out of this Interval, an alarm will be shown in the screen.

Other Relevant Information

Issue/Problem	Solution	Example
Can I clean it with high pressure water?	It is possible. Try not to aim insisting on the e-ChemSavers for too long time, particularly to the electrical connector.	



DynaJet® IC7140

Main Setup -> Machine Setup

Description	Factory Default	Range/Options	Suggested Setting	Use Default
Nozzle Spacing	50 cm / 20 in	1 - 2,000 cm / 1 - 787 in		<input type="checkbox"/>
Pressure Sensor Maximum	10 bar / 145 psi	5.00 - 30.00 bar / 73 - 435 psi		<input type="checkbox"/>
Minimum Duty Cycle	30%	20% - 40%		<input type="checkbox"/>
Control Hold Delay	1.0 seconds	0.0 - 10.0 seconds		<input type="checkbox"/>
Gain Preset	Preset 1	<ul style="list-style-type: none"> • Preset 1 • Preset 2 • Preset 3 • Preset 4 • Preset 5 		
Number of Sections				
with one (1) BIM	0	1 - 15		<input type="checkbox"/>
with two (2) BIMs	0	1 - 30		<input type="checkbox"/>
with Individual Nozzle Shutoff Unlocked	0	1 - 240		<input type="checkbox"/>
Nozzles per Section	0	1 - 240		<input type="checkbox"/>

Main Setup -> Gain Preset Setup

Preset	Description	Factory Default	Range/Options	Suggested Setting	Use Default
#1	Proportional Gain	4	1 - 30		<input type="checkbox"/>
	Derivative Gain	6	0 - 20		<input type="checkbox"/>
#2	Proportional Gain	4	1 - 30		<input type="checkbox"/>
	Derivative Gain	6	0 - 20		<input type="checkbox"/>
#3	Proportional Gain	4	1 - 30		<input type="checkbox"/>
	Derivative Gain	6	0 - 20		<input type="checkbox"/>
#4	Proportional Gain	4	1 - 30		<input type="checkbox"/>
	Derivative Gain	6	0 - 20		<input type="checkbox"/>
#5	Proportional Gain	4	1 - 30		<input type="checkbox"/>
	Derivative Gain	6	0 - 20		<input type="checkbox"/>

Main Setup -> User Interface

Description	Factory Default	Range/Options	Suggested Setting	Use Default
Use Preferred UT	Off	<ul style="list-style-type: none"> • Off • On 		<input type="checkbox"/>
Boom Section Beep	Off	<ul style="list-style-type: none"> • Off • On 		<input type="checkbox"/>
Turn Compensation Visual	On	<ul style="list-style-type: none"> • Off • On 		<input type="checkbox"/>

Unlock Options

Description	Unlock Code
Standard Turn Compensation	
Advanced Turn Compensation	
Individual Nozzle Shutoff	
Variable Rate (VRA)	

Nozzle Favourites

Preset	Specific Nozzle	Nozzle Series	Nozzle Capacity
#1			
#2			
#3			
#4			
#5			

Notes

Main Setup -> OEM Settings

Description	Factory Default	Range/Options	Suggested Setting	Use Default
PWM Frequency	20 Hz	5 - 25 Hz		<input type="checkbox"/>
On Pulse Duration	38 counts	0 - 128		<input type="checkbox"/>
Hold Current Frequency Adjustment	10 counts	5 - 20		<input type="checkbox"/>
Hold Current Duty Cycle	5 counts	0 - 20		<input type="checkbox"/>
Phase Offset	128 counts	0 - 255		<input type="checkbox"/>
Jump Point	0.35 bar / 5 psi	0.00 - 2.11 bar / 0 - 31 psi		<input type="checkbox"/>
Maximum Duty Cycle	92%	70% - 100%		<input type="checkbox"/>
PWM Off Time	20	0 - 100		<input type="checkbox"/>
Low Voltage Limit	11.0V	0.0 - 20.0V		<input type="checkbox"/>
High Voltage Limit	15.0V	0.0 - 20.0V		<input type="checkbox"/>
Low Amps Limit	0.4A	0.0 - 20.0A		<input type="checkbox"/>
High Amps Limit	1.2A	0.0 - 20.0A		<input type="checkbox"/>
High Pressure Alarm	6.0 bar / 87 psi	4.0 - 25.0 bar / 58 – 363 psi		<input type="checkbox"/>
Droplet Size Damping	0.10	0.01 - 0.99		<input type="checkbox"/>
ECU Orientation	Horizontal, Label Up	<ul style="list-style-type: none"> • Horizontal, Label Up • Horizontal, Label Down • Vertical, Connectors Up • Vertical, Connectors Down • Vertical, Left Edge Up • Vertical, Right Edge Up 		<input type="checkbox"/>
Regulation Base	Pressure Based	<ul style="list-style-type: none"> • Pressure Based • Flow Based 		<input type="checkbox"/>
Solenoid Error State	All Open	<ul style="list-style-type: none"> • All Open • All Closed 		<input type="checkbox"/>
Solenoid Disengage State	All Open	<ul style="list-style-type: none"> • All Open • All Closed 		<input type="checkbox"/>



DYNAJET® IC7140

INSTALLATION / SETUP / USER MANUAL

Key Features and Benefits:

- Nozzles operate on/off at 20 Hz frequency
- Alternating nozzles ensure proper spray coverage
- High flexibility without changing nozzles
 - Accommodate various application rates
 - Increased speed range for higher productivity
- Adjust droplet size on-the-go
- Flow rate (litre/minute or gallon/minute) determined by Duty Cycle
 - For example: 50% (50% On & Off), turns a 05 nozzle to a 025
- 90% drift reduction with AIC11005 VP/VS or AITTJ6011004 VP
- Optional: ISOBUS technology with turn compensation

